

Historic, Archive Document

Do not assume content reflects current scientific knowledge, policies, or practices.

1935



NEW MARIGOLD
Dwarf Royal Scot Alldouble
(See Novelties)

SEEDS BULBS *and* PLANTS

AGRICULTURAL
IMPLEMENTS

for

1937

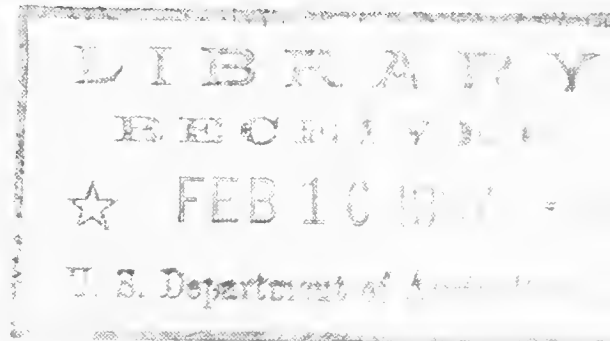

THOMAS J. GREY COMPANY

The Seedsman

16 South Market St., BOSTON, MASSACHUSETTS

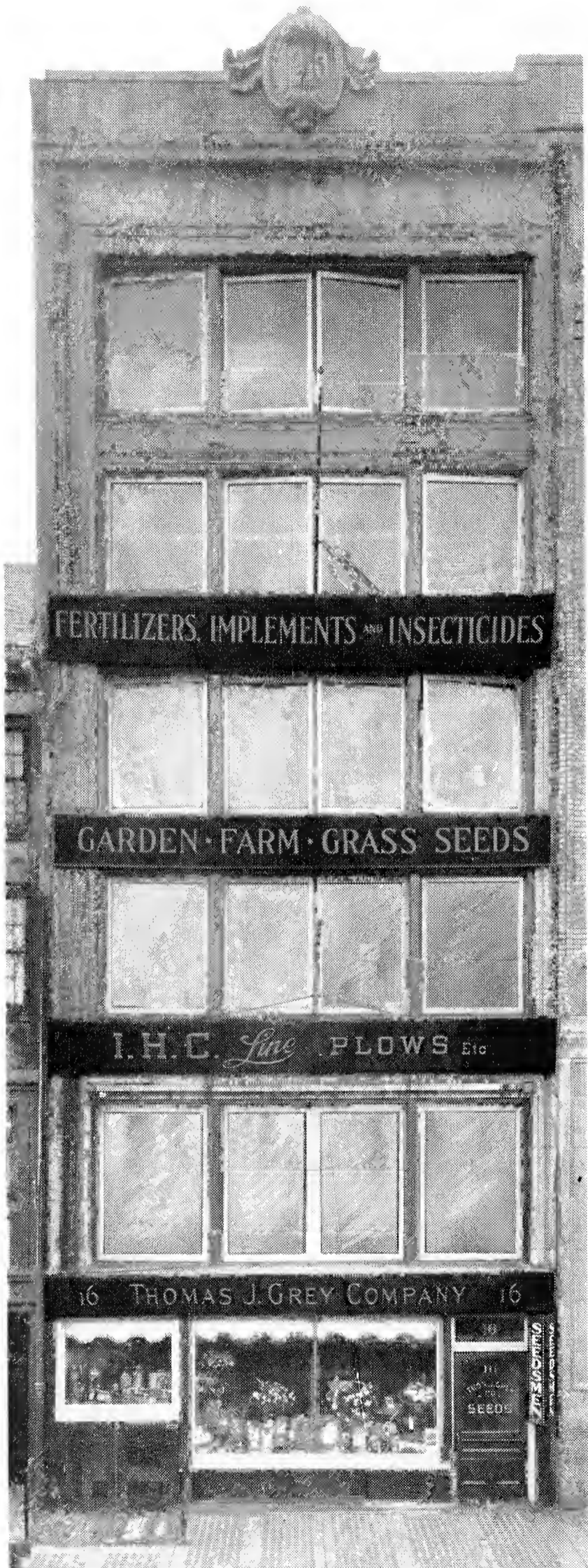

49 Years of FAITHFUL SERVICE

THE Thomas J. Grey Company's catalog for 1937 is presented to you as a guide in planning your garden work for the year. Whether your garden is large or small, you will obtain the best possible results, and the maximum amount of pleasure by sowing the selected strains of seeds we offer in the following pages. We stock only the best of the old favorite varieties and the cream of the newer introductions. For bulbs for autumn planting we refer you to our 1937 Bulb catalogue, ready in August.

Our line of garden tools and farm implements is one of the most extensive, and space in this catalog does not permit a complete listing. Several floors in our newly refinished building are devoted to the display of the highest grade domestic and imported garden tools and equipment.

We maintain also a complete power and hand lawn mower service department for the sharpening and repairing of all makes of mowers. We are headquarters for Boston and vicinity for the famous Coldwell line of power and hand mowers.

To better serve an increasing number of customers, we have recently added a modern, completely equipped street-floor salesroom. Here you will be served by trained seedsmen, always glad to assist you in dealing with your gardening problems. When in Boston you are cordially invited to visit our store. Those who prefer to do business by mail will find our mail-order department prompt and efficient. We invite your inquiries.

THOMAS J. GREY COMPANY "The Seedsmen"

16 SOUTH MARKET ST.

BOSTON, MASS.

Telephones: CAPitol 7476 - 7477

ROBERT E. MONTGOMERY, Pres. FRANCIS R. CONBOY, Secy. JOHN P. A. GUERINEAU, Treas.

Novelties and Specialties In Flower Seeds for 1937

Antirrhinum

NEW RUST PROOF SUPER MAJESTIC

- 366 **AUTUMN GLOW SHADES.** Old rose suffused amber, with golden lip.
- 367 **DAINTY.** Delightful soft pink.
- 368 **HARMONY.** Terra cotta and yellow shaded rose.
- 369 **ORANGE SHADES.** Marvelous shades of rose deeply overlaid with tangerine or golden orange.
- 370 **RED.** Deep crimson, garnet and ruby shades.
- 371 **ROSE.** Rich begonia rose—immense spikes.
- 372 **SILVER PINK.** Lovely deep pink with white blotch on lower lip.
- Above varieties; pkt. 35c. Collection of 7, \$2.00.

Aquilegia Clematiflora

- 448 The plants are of medium height, good compact habit and free flowering. The petal formation is absolutely distinct, the blooms greatly resembling Clematis flowers. Mixed colors. Color range includes delicate pastel shades of pink and blue. Pkt. 50c.

Aster

- 1026 **NEW CALIFORNIA GIANT SUNSHINE STRATOSPHERE.** The guard petals are pansy violet and the quilled petals are lavender with the center orange. Pkt. 25c.

Begonia

- 1176 **WINTER ROMANCE.** Rich carmine-scarlet. Pkt. 75c.
- 1177 **WINTER ROMANCE WHITE.** Seed sown in July flowers at Christmas. Pkt. 75c.
- 1178 **"TAUSENDSCHOEN" GRACILIS COMPACTA.** Grows about 5 inches high and makes a plant of regular compact growth. The flowers are of rich rose in a profusion of bloom. Equally good for bedding or conservatory use. Pkt. 75c.



Aquilegia Clematiflora

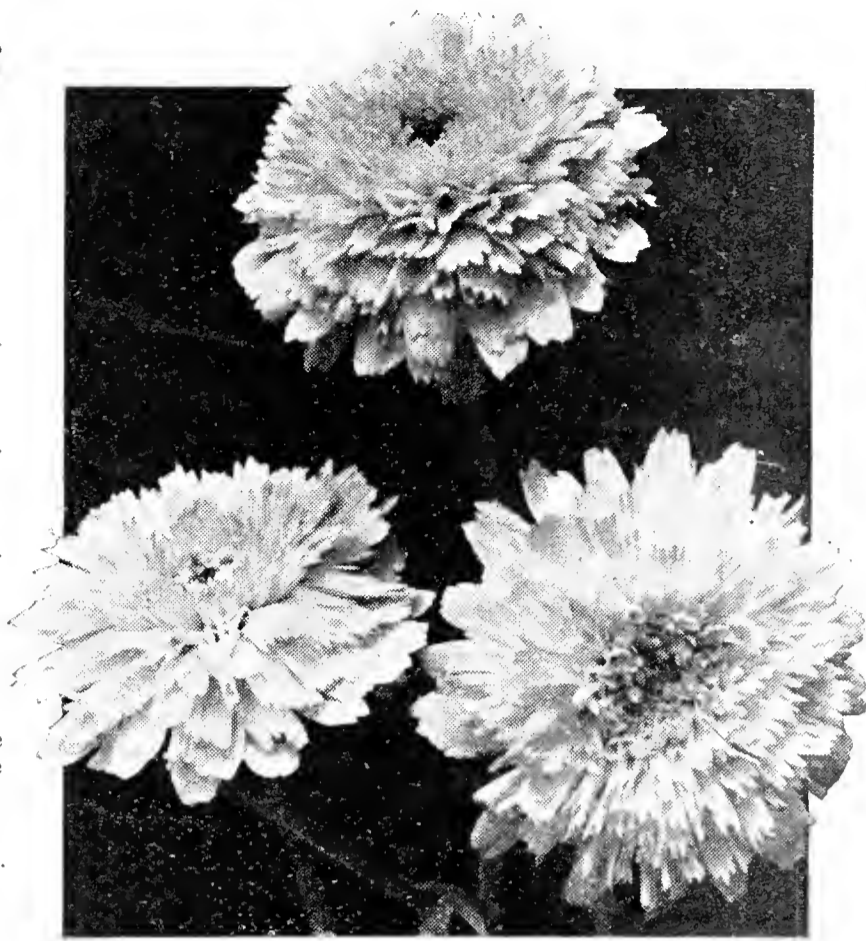

Chrysanthemum, Yellowstone

Delphinium

- 2369 **HOODACRES HYBRIDS MIXED.** A beautiful hardy type from the northwest. Long flower spikes and excellent color range. Pkt. \$1.00.

Chrysanthemum

- 1812 **YELLOWSTONE (Segetum Double).** Hardy annual, 2 ft. The full double bright yellow flowers are borne on good straight stems, making this variety especially welcome for cutting. Pkt. 25c.

Godetia

- 2932 **KELVEDON GLORY.** The color of this new variety is deep glowing salmon-orange of intense vividness. The blooms are of beautiful symmetry and fine texture. Plants are strong and robust and unusually free flowering. Pkt. 35c.

Lilium Philippinense

- 5239 **FORMOSANUM IMPROVED.** Long white trumpet flowers, slightly marked externally reddish brown. Pkt. 50c.

Linaria

- 5242 **FAIRY BRIDESMAID.** The bushy plants, about 8 inches high, spread a luxurious wealth of bloom of a citron-yellow hue, giving a most effective display. Pkt. 25c.

Lupinus New Giant King

The full grown plants attain a height of from three to four feet. They are base branching, each plant sending out from 6 to 8 enormous flower spikes. The beauty is enhanced by a narrow white stripe in the center of the standard. Blooms from 75-90 days from sowing and enjoys a long flowering season. Annual.

- 5331 Heliotrope. 5333 Pure White.
5332 Oxford Deep Blue. 5334 Sky Blue.

Collection, 4 colors, 75c. Separate colors, pkt. 20c.

FLOWER SEED NOVELTIES AND SPECIALTIES—Continued

Marigold

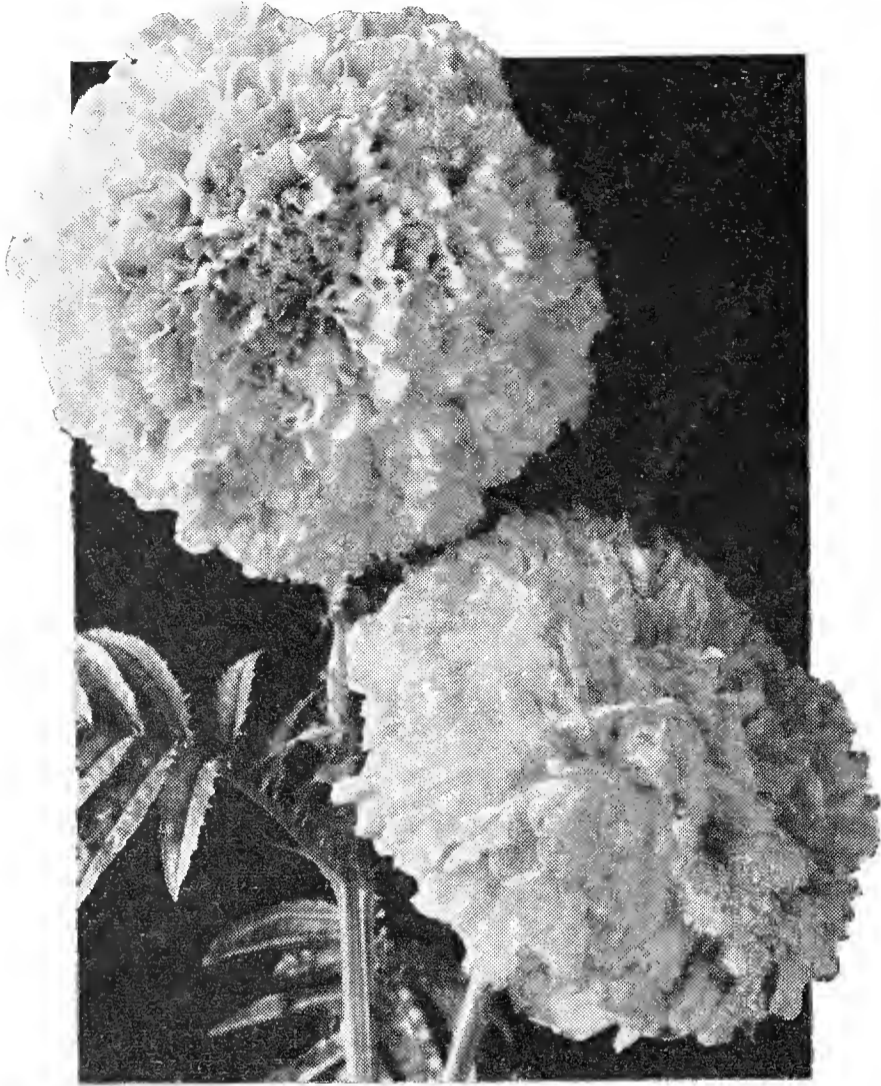

Marigold Gigantea Sunset Giants

5453 **CHRYSANTHEMUM FLOWERED CALIFORNIA GIANTS MIXED.** Enormous flowering type, plants 4-5 ft. high. Most blossoms have broad flat petals but some come quilled. Colors range from lemon to bright orange. Pkt. 15c.

5454 **GIGANTEA SUNSET GIANTS.** Flowers have a definitely sweet fragrance, and are loosely formed and very large, measuring 5-7 inches across. Color ranges from deep orange through golden and lemon shades to light primrose. Pkt. 25c.

Carnation Flowered Type

5455 **GOLDEN EAGLE.** Early flowering, same habit and form as Guinea Gold, but the color is a delightful shade of luminous gold. Plants come 100% double and are practically lacking the usual Marigold odor. Pkt. 25c.

5459 **GUINEA GOLD.** Flowers loosely double, orange flushed with gold. A fine cut flower variety. Pkt. 25c.

5462 **LEMON GEM.** Same as above except the color which is rich lemon yellow. This variety makes wonderful long lasting cut flowers. Pkt. 25c.

5474 **YELLOW SUPREME.** Large fluffy blooms of creamy lemon yellow; free from the Marigold odor. Pkt. 25c.

5503 **DWARF ROYAL SCOT ALL DOUBLE.** Height 10-12 inches. Color rich mahogany and gold in uniform stripes. Plants are dwarf, bushy, uniform in shape and height. Pkt., 25c. (See illustration in color on cover).

5513 **LIEB'S WINTER FLOWERING.** Excellent to follow Chrysanthemums in the greenhouse. Seed sown from July to December will bloom continuously from October to May. Flowers are about 3 inches across, single and semi-double in formation, deep mahogany brown with golden yellow crested centers. Stems are fine and long on plants 3 to 4 ft. tall. Not subject to any insect pest. Pkt. 25c.

5518 **TAGETES, Signata Pumila Little Giant.** Very deep orange, free flowering; compact habit. 6 inches. Pkt., 15c.

Pansy

SWISS GIANTS OR ROGGLI

6147 **MIXED COLORS.** Enormous size, very long stems; flowers 3-5 blotched. $\frac{1}{8}$ oz., \$2.00. Pkt. 50c.

6162 **ALPENGLAW.** Rich deep Indian red and cardinal shades. Pkt. 50c.

6163 **BERNA.** Dark velvety violet blue. Pkt. 50c.

6238 **DWARF GIANTS.** Rich and various shades of mammoth flowers on dwarf plants. Pkt. 50c.

6239 **GOLDEN BLOTCHED.** (Rhinegold) Canary yellow with dark blotches. Pkt. 50c.

6240 **PURE YELLOW SWISS.** Clear golden yellow. Pkt. 50c.

6241 **SILVER BRIDE.** White. Pkt. 50c.

6242 **ULLSWATER BLUE** (Lake of Thun). The deepest of all blue pansies, black blue center. Pkt. 50c.

Petunia

6368 **"VICTORIOUS."** Fancy double frilled giant flowers, many 5 inches across. Are beautifully fringed and ruffled, and have a wide color range of exquisite colors. The plants are dwarf growing. Pkt. \$1.00.

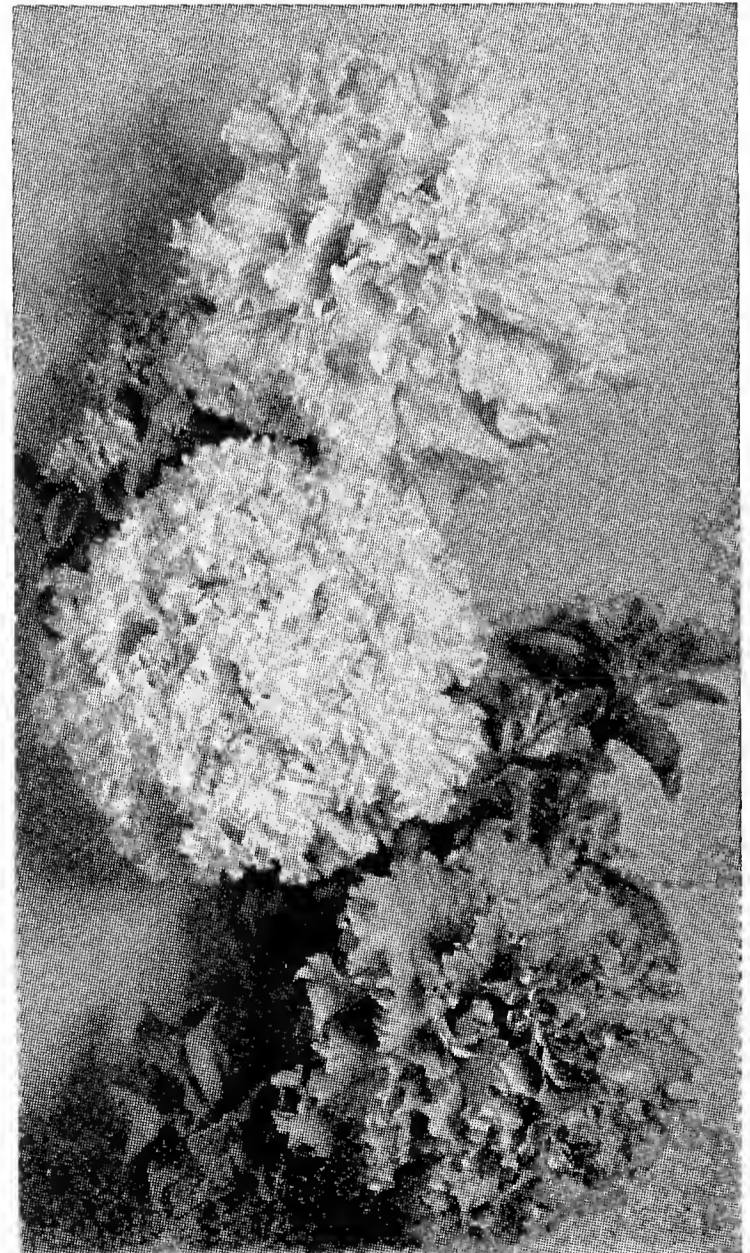

Petunia "Victorious"

FLOWER SEED NOVELTIES AND SPECIALTIES—Continued

Primula Veris Elatior Gigantea

Large flowers of pure clear colors, lifting themselves high above the foliage on stems 8-10 inches high. Effective for pot plants or can be easily forced in cold frames for bedding and cut flowers. Separate colors only.

- | | |
|---------------|----------------|
| 6968 A Lilac. | 6968 D Violet. |
| 6968 B Pink. | 6968 E White. |
| 6968 C Red. | 6968 F Yellow. |

Pkt. 75c.

Salpiglossis—New Dwarf Giant Flowering

Compact branching habit with flowers half again as large as the ordinary type. Plants are very free flowering and ideally suited for bedding.

- | | |
|---------------------------|----------------------------|
| 7082 Blue and gold. | 7087 Deep velvety crimson. |
| 7084 Bright scarlet. | 7088 Lilac. |
| 7086 Dark brown and gold. | 7089 Scarlet and gold. |

Pkt. 25c; collection 6 colors, \$1.25

Scabiosa "Rosette"

7181 A new annual grandiflora Scabiosa of a beautiful shade of deep rose suffused salmon. The flowers are extra large and the stems are long and stiff. Pkt. 25c.

Sedum

7239 REFLEXUM "CHAMELEON." Plants are dwarf and of spreading habit. Young shoots are green at first but as the season advances the tips become colored yellow, apricot, and salmon shades. In July and August flower stalks rise 8-10 inches above the prickly cushion and the flowers are bright canary yellow. Pkt. 35c.

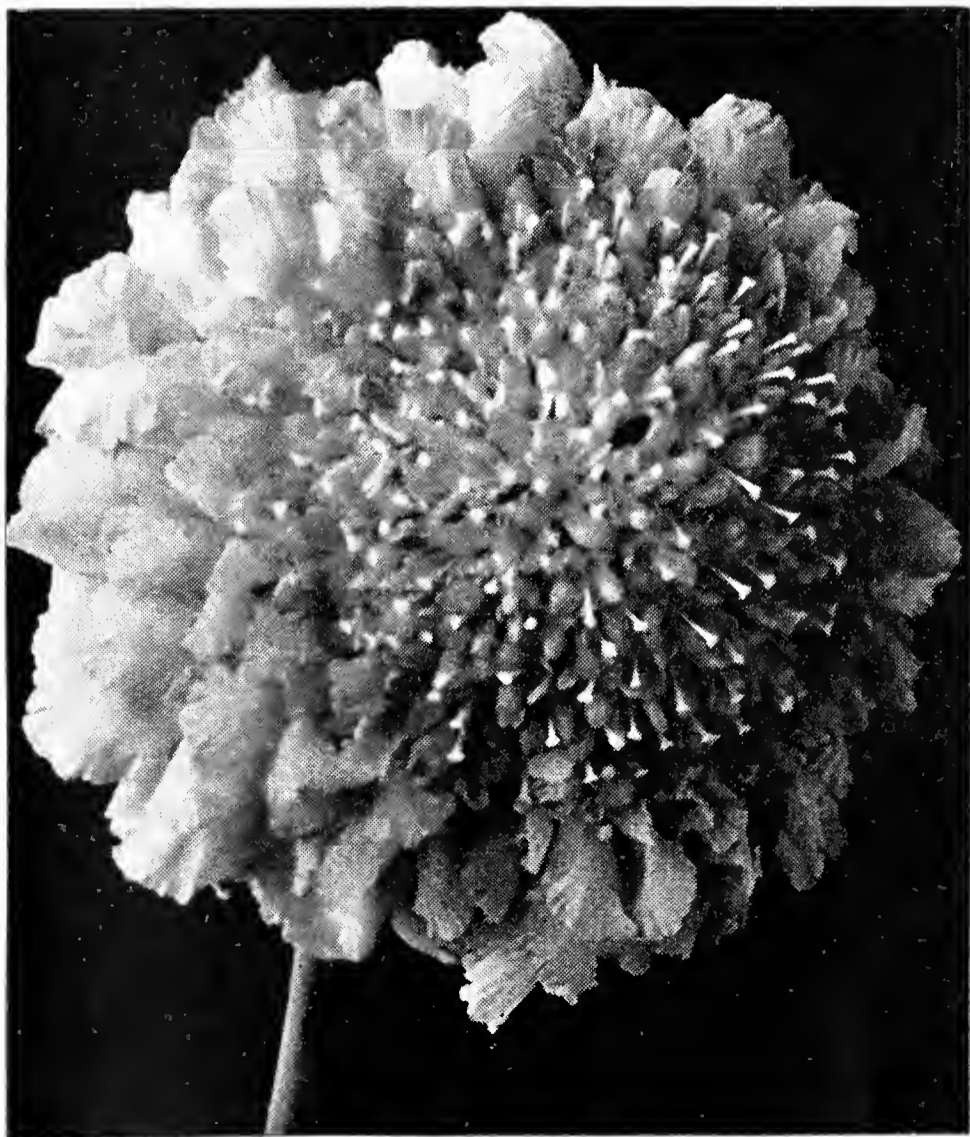

Scabiosa "Rosette"

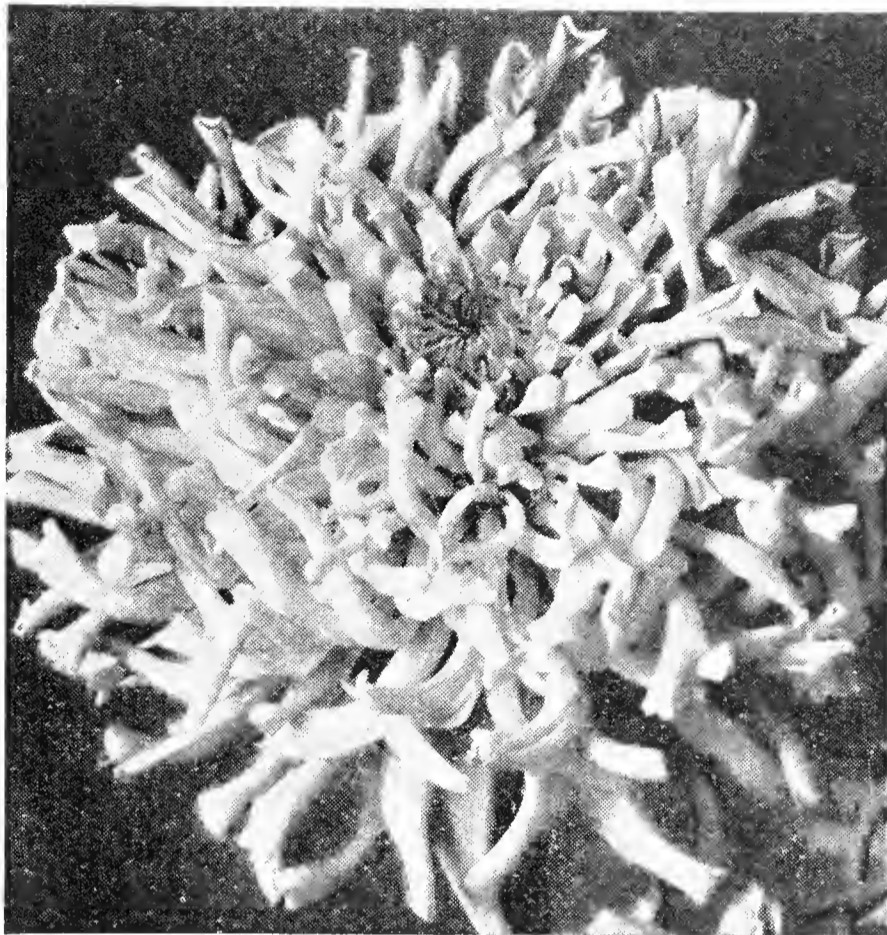

Zinnia Fantasy Star Dust

Stock

SUPER GIANT IMPERIAL ROSE CHARM

7408 Plants are full base branching, each plant producing 12-15 huge flower spikes. Individual florets are large and very double measuring 1½-2 inches across. The color is a rich deep rose. Pkt. 25c.

Thunbergia

8118 GIBSONI. This new variety has large flowers of rich glowing orange. It is a graceful climber for trellis covering outdoors or in the greenhouse. Pkt. 50c.

Viola

8283 HYBRIDA CHANTREYLAND. A choice bedding variety of pure apricot color. Pkt. 25c.

Viscaria

Viscarias are becoming extremely popular and some of the most outstanding bedding effects have resulted from broadcast sowings.

8316 BLUE PEARL. Pure delicate lavender-blue, without eye. The plant is very free flowering and is tidy and erect. Pkt. 25c.

8317 FIRE KING. Bright scarlet selected strain. Pkt. 25c.

8318 INNOCENCE. Compact pure white. Pkt. 25c.

8319 ROSE BEAUTY. Bright deep rose, petals fringed and lacinated. Plants 18 inches high. Pkt. 25c.

8319A. TOM THUMB BLUE GEM. Ultramarine-blue. Pkt. 25c.

Zinnia

8447A. FANTASY STAR DUST. The shaggy-petaled medium sized flowers are a rich deep golden yellow shade. Plants are very free flowering and early blooming. Pkt. 25c.

8479 DOUBLE DWARF SPUN GOLD. A delicate pastel shade of butter yellow. Flowers are 2½-3 inches across on plants 12-18 inches high. Early flowering strain. Pkt. 20c.

FLOWER SEED NOVELTIES AND SPECIALTIES—Continued

Seeds of Hardy Rock Garden Plants

- 102 **AETHIONEMA** (Persian Candytuft). 9 in. June-July. Sun. Strong, twiggy bushes with long, slender spikes of rosy pink flowers. Pkt. 30c.
- 202 **ALYSSUM serpyllifolium** (Alpestre). Very dwarf. 4-5 in. Racemes of pale yellow flowers and rough, hoary leaves. Blooms just after the well known Saxatile variety. Pkt. 20c.
- 203 **ALYSSUM**. Rock Garden Perennial. Rare species mixed. Pkt. 15c.
- 252 **ANEMONE pulsatilla** (Pasque Flower). 10 in. April-May. An interesting plant producing violet or purple flowers. Pkt. 25c.
- 432 **AQUILEGIA alpina**. Dwarf, dark blue. Pkt. 25c.
- 519 **ARENARIA** (Sandwort). *Montana*. 6-8 in. Grows in close tufts of bright green foliage, profusely covered in the spring with small silvery white flowers. Pkt. 25c.
- 1066 **AUBRIETIA Campbelli**. Very large deep blue flowers on plant of creeping habit, 6 in. Excellent for rockeries and edging. Pkt. 35c.
- 1068 **AUBRIETIA Eyri**. A dainty low creeping plant. Fine for crevices of rocks. Rosy lilac, flowers for a long period. Pkt. 30c.
- 1292 **CALANDRINIA umbellata**. 4-5 in. Will do well in a hot location where other plants may not succeed. Bright crimson saucer-shaped flowers. Prostrate habit. Pkt. 20c.
- 1392 **CAMPANULA garganica**. June. A low spreading tuft with starry light blue flowers, small white eye. Fine for hanging over a rock. Pkt. 35c.
- 1401 **CAMPANULA barbata**. 1 ft. Called Queen of the Lower Alpine Meadows. Large grayish blue bells on 12-in. stems. Pkt. 25c.
- 1403 **CAMPANULA Raineri**. Erect blue flowers in June, July. Plant dwarf, spreading. Pkt. 25c.
- 1435 **CAMPANULA rotundifolia** (Scotch Bluebells). 1 ft. June to Aug. Clear blue flowers, especially adapted for crevices. Also does well on steep slopes. Pkt. 25c.
- 2498 **DIANTHUS CAESIUS GRANDIFLORUS** (Cheddar Pinks). Rosy pink, 6 inches. Pkt. 15c.
- 2510 **DIANTHUS Allwoodi alpinus**. 6 in. June-July. Glossy foliage with large bright rose flowers. Thrives best in loam to which a little lime has been added. Shade a little in hottest part of summer. Pkt. 50c.
- 2526 **DIANTHUS WINTERI**. Flowers of pure colors, habit compact, deliciously scented. Quite hardy and blooms first year from seeds. Pkt. 50c.
- 2658 **ERINUS alpinus roseus**. 4 in. May-June. The foliage grows in rosettes, the flowers in racemes of rosy purple. Fine for pockets or between steps. Pkt. 25c.
- 3026 **GYPSOPHILA repens**. Trailing rose-pink Baby's Breath. $\frac{1}{8}$ oz. 40c, pkt. 15c.
- 5228 **LAVANDULA, Munstead Strain**. 1 ft. Dwarf, compact, early flowering type with deep lavender flowers. Pkt. 25c.
- 5247 **LINUM, alpinum**. Beautiful true blue flax of spreading habit, blooming in May and June. Best rock garden variety. Pkt. 25c.
- 5248 **LINUM flavum nanum compactum**. Glowing yellow new dwarf Flax suitable for borders and rockeries. Pkt. 25c.
- 5388 **LYCHNIS alpina**. 1 ft. A pretty dwarf plant with clusters of brilliant rose colored flowers in spring and early summer. Pkt. 25c.
- 6012 **NEPETA Mussini** (Ground Ivy). 1-1 $\frac{1}{2}$ ft. Fine in the rock garden; compact habit, producing masses of lavender flowers. Pkt. 25c.
- 6014 **NEPETA nervosa** (Catmint). 1 ft. Bright, clear blue. Pkt. 25c.
- 7152 **SAXIFRAGA umbrosa** (London Pride). Sun or shade. Numerous small pink flowers, fine for rocks or edging; foliage a solid carpet. Pkt. 30c.
- 7242 **SEDUM spurium coccineum** (Stonecrop). 6 in. July and Aug. Sun. Showy rosy crimson flowers. They thrive in almost any soil. Pkt. 25c.
- 7262 **SILENE Schafta** (Autumn Catchfly). 4 to 6 in. July to Oct. When in flower, they are a mass of bright pink. Pkt. 20c.
- 8162 **TUNICA saxifraga** (Coatflower). 6 in. Beautiful tufted plant with light pink flowers all summer. Fine for border or rockery. Pkt. 20c.
- 8223 **VERONICA incana (candida)**. 1 ft. July-Aug. A white, woolly plant with numerous blue flowers. Makes a fine show even when not in bloom. Pkt. 25c.
- 8228 **VERONICA teucrium**. Royal blue. 1-ft. Valuable for rockeries and dwarf borders. Pkt. 25c.

Other Seeds of Rock Garden Plants to be Found in Catalog

Hardy Varieties: *Alyssum saxatile compactum*, *Achillea*, *Arabis*, *Armeria*, *Asperula*, *Aubrietia*, *Campanula carpatica*, *Cerastium*, *Cheiranthus*, *Dianthus deltoides*, *Edelweiss*, *Geum*, *Helianthemum mutabile*, *Heuchera*, *Iberis* (Perennial Candytuft), *Linum*, *Primula* (hardy varieties), *Sedum*.

Annual Varieties: *Alyssum*, Dwarf; *Antirrhinum*, Tom Thumb varieties; *Candytuft*, dwarf varieties; *Marigold*, dwarf varieties; *Mesembryanthemum*; *Petunia*, dwarf varieties; *Portulaca*; *Silene*; *Viola cornuta*, *Zinnia Lilliput*, and *Gem* varieties.



Aubrietia eyri



Nepeta mussini



Tunica saxifraga

Grey's Superior Flower Seeds

A very carefully revised list to which many meritorious and recently introduced sorts have been added and all inferior varieties discarded.

All flower seeds mailed free on receipt of price quoted.

If the number is used when ordering, it will not be necessary to write the name.



No.		Pkt.	No.		Pkt.
10	ABUTILON, Prize Mixed (Flowering Maple). Perpetual bloomers and rapid growers; seed sown indoors in March will produce plants that will bloom outdoors during the summer and indoors all winter....	\$0.25			
	ACACIA. Beautiful half-hardy shrubs, with pretty, ornamental foliage and graceful racemes of yellow flowers. Soak the seeds in warm water before sowing. 6 to 10 ft.				
15	<i>baileyana</i> . Long sprays of bright yellow flowers; excellent for cutting. 1/4 oz.	50c .25			
20	<i>floribunda</i> . Deep yellow	1/4 oz. 35c .15			
25	<i>lophantha speciosa</i> . Fine yellow, delicate foliage	1/4 oz. 35c .15			
30	Finest Mixed Varieties. From a large collection	1/4 oz. 35c .15			
	ACANTHUS. Stately ornamental, hardy perennials, remarkable for their beautiful foliage, and curious flowers in Aug. and Sept. 2 to 4 ft.				
35	<i>mollis</i> . The beautiful foliage of this sort is said to have given rise to the Corinthian style of architecture; flowers white.	1/4 oz. 35c .15			
40	<i>mollis latifolius</i> . Handsome sort; more robust than the preceding	1/4 oz. 35c .15			
45	ACHILLEA, The Pearl. One of the best hardy perennials, covered with heads of pure white, double flowers from spring till frost; fine for cutting; 1 1/2 ft.	1/16 oz. \$1.50 .25			
50	ACHIMENES, Superb Mixed. Profuse blooming greenhouse plants, 1 ft. high, easily grown and flowering through the summer. The flowers vary in size and are of the richest colors	.50			
	ACONITUM (Monkshood). Hardy perennials, with long spikes of hood-shaped flowers, excellent for shrubby borders and shady places. June to Sept.				
52	<i>lycoctonum</i> . Pale yellow. 3 ft.	.20			
55	<i>napellus</i> . Large deep blue. 3 ft.	1/4 oz. \$1.25 .15			
60	<i>napellus roseum</i> . Pink	.25			
68	<i>wilsoni</i> . Large trusses, light blue. 4 ft.	.25			
70	Finest Mixed	1/4 oz. 60c .10			
	ACROCLINIUM. One of the prettiest and best annual everlasting for cutting fresh or for Winter use. For drying they should be cut before fully open and hung in an airy room to dry, heads down. 15 in.				
75	Double Rose	1/4 oz. 35c \$0.10			
80	Double White	1/4 oz. 35c .10			
84	Double New Giant Hybrids	1/4 oz. 75c .15			
90	ADLUMIA cirrhosa (Mountain Fringe, or Allegheny Vine). Beautiful climber, Maidenhair fern-like foliage, pink flowers, a self-sowing, hardy biennial. 15 ft.	1-16 oz. 75c .15			
	ADONIS. Free-flowering border plants, with showy flowers of easy culture in any garden soil.				
95	<i>aestivalis</i> (Flos Adonis). Deep crimson, free flowering annual. 1 ft. July and Aug.	1/4 oz. 25c .10			
100	<i>vernalis</i> . Large, yellow flowers in May and June. Hardy perennial. 1 ft.	1/4 oz. \$1.00 .10			
105	AGATHEA coelestis (Blue Marguerite). Free blooming, tender perennial with blue daisy-like flowers. Fine for winter flowering and a good bedder. 1 1/2 ft.	.25			
	AGERATUM. Effective plants for bedding, covered with bloom throughout the season. Valuable for cutting. Half-hardy annual.				
106	Blue Ball. 4 in., deep blue	.25			
108	Blue Cap. Large, deep blue flowers, small foliage; 5 in.	.25			
110	Blue Perfection. Deep blue	1/4 oz. 60c .15			
115	Blue Star. Bright light blue; 5 in.	1/8 oz. 75c .25			
120	Imperial Dwarf. Dark blue; 8 in.	1/4 oz. 75c .15			
125	Imperial Dwarf. White; 8 in.	1/4 oz. 85c .15			
135	Little Dorrit. Azure blue; 8 in.	1/8 oz. 50c .10			
140	mexicanum. Large, lilac-blue; 1 1/2 ft.	1/4 oz. 50c .15			
145	mexicanum album grandiflorum. Large white; 1 1/2 ft.	1/4 oz. 50c .15			
150	Princess Victoria Louise. Bright blue, white center; 8 in.	1/4 oz. 75c .15			
152	Venus. Dwarf pink, 6 in.	.15			

No.		Pkt.
155	AGROSTEMMA coronaria (Mullein Pink). Free flowering, hardy perennial, bright crimson flowers; fine for cutting; 2 ft. ¼ oz., 25c	\$0.10
160	hybrida walkeri . Bright rose; hardy.....	.15
165	coelirosa (Rose of Heaven). Fine annual sort, with rose flowers. Fine for cutting; 1½ ft..... ¼ oz. 25c	.10
170	ALONSOA, Mixed (Maskflower). Charming annual, flowering throughout the summer and autumn; easily grown and very desirable. 1½ ft..... ⅓ oz. 30c	.15
175	ALSTROEMERIA, Finest Mixed . Handsome, lily-like, half-hardy perennials, varying from pale yellow to orange red; 3 ft. ¼ oz. 75c	.25
	ALYSSUM . Dwarf-growing annuals, blooming profusely throughout the season.	
180	benthami (Sweet Alyssum). White, fragrant, free bloomer; 1 ft. 4 ozs. \$1.50, oz. 50c	.10
185	Carpet of Snow (White Fleece). Pure white, very dwarf and sweet; 4 in..... ¼ oz. 40c, oz. \$1.25	.15
187	Lilac Queen . Dwarf annual.... ¼ oz. 50c	.10
190	Little Dorrit . A perfect gem for borders or beds, compact, white and sweet. ¼ oz. 40c	.15
195	Little Gem . White, distinct and very sweet. ½ ft. ¼ oz. 30c, oz. \$1.00	.10
196	Lutescens . 6 in. Annual; creamy yellow.. ¼ oz. 40c	.15
198	Minimum . 3 in. Very dwarf compact white ¼ oz. 40c	.15
200	saxatile compactum (Gold Dust). Bright, yellow, spring flowering, hardy perennial; 9 in. ¼ oz. 85c, oz. \$3.00	.15
201	saxatile, Silver Queen . Pale yellow ⅓ oz. 75c	.15
	AMARANTHUS . Brilliant foliaged annuals, with showy racemes of flowers; very ornamental and excellent for borders and sub-tropical gardening.	
205	caudatus (Love-lies-bleeding). Long drooping, scarlet racemes; 3 ft. ¼ oz. 25c	.10
212	Molten Fire . Brilliant poinsettia-like tips.	.15
215	salicifolius (Fountain Plant). Long foliage, beautifully variegated; 3 ft. ¼ oz. 35c	.10
220	tricolor splendens (Joseph's-coat). Foliage crimson, yellow and bronze; 2 ft. ¼ oz. 50c	.15



Anchusa Italica



Amaranthus Salicifolius



Alyssum, Carpet of Snow

No.		Pkt.
225	AMARYLLIS, Special Hybrids (Hippeastrum). Saved from extra large flowering varieties	\$0.50
230	AMBROSIA mexicana . Sweet-scented annual. Useful in bouquets; 1 to 1½ ft. ¼ oz. 40c	.10
235	AMPELOPSIS veitchi (Boston Ivy). Popular rapid growing hardy vine ¼ oz. 35c	.10
238	ANCHUSA, Blue Bird . Annual. Indigo blue..	.30
240	capensis . Annual. Fine azure blue Forget-me-not-like flowers. 1 ft. ⅓ oz. 35c	.10
242	barrelieri . Perennial. Dwarf, blue.....	.25
245	italica, Dropmore Variety . Perennial. Gentian blue; 4 ft. ¼ oz. 85c	.25
246	Lissadell . Perennial. Bright gentian blue; 5 ft.35
248	Myosotidiflora . Perennial, 1 ft. May. A Russian variety with clusters of blue flowers resembling Forget-me-nots.....	.25
250	ANEMONE coronaria, St. Brigid . An improved strain of the hardy garden Anemone, with larger and more brilliant flowers; 1 ft.20
251	De Caen (French Anemone). Mixed15
253	ANTHEMIS arabica . Annual yellow10
255	kelwayi (Hardy Marguerite). A most satisfactory, hardy perennial, bearing throughout the summer golden yellow daisylike flowers, excellent for cutting; 2 ft. ⅓ oz. 50c	.10
	ANTHERICUM . One of the finest ornamental garden plants, producing freely fine spikes of sweet scented, lily-like flowers from May to July. Hardy perennial. 1½ ft.	
258	liliastrum Giant (St. Bruno lily). Large white, with green spots.... ⅓ oz. \$1.00	.25

ANTIRRHINUM (Snapdragon). (**Rust-Proof**). The advent of the Rust-Proof Antirrhinum is destined to make them the most popular flower in America.

MAXIMUM TYPE

No.		Pkt.
260	Alaska. Glistening white	\$0.25
261	Canary Bird. Soft yellow25
262	Copper Shades25
263	Fair Lady. Light pink, white tube25
264	Loveliness. Soft rose25
265	Red Cross. Deep crimson25
266	Maximum Mixed25
268	Collection of 6 Varieties	1.25

(See page 1 for additional Rust-Proof Snapdragons)

TALL GIANT VARIETIES, 2½-3 ft.

No.		Pkt.
270	Mixed. Finest sorts ¼ oz. 60c	\$0.15
275	Cardinal. Dazzling scarlet ¼ oz. 65c	.15
280	Cattleya. Rosy lilac25
285	Copper King. Bronzy copper25
290	Crimson King. Deep crimson.... ¼ oz. 65c	.15
295	Fairy Queen. Rich salmon-orange. ¼ oz. 65c	.15
305	Golden King. Giant yellow ¼ oz. 65c	.15
310	Orange Beauty. Orange-scarlet, gold lip..	.25
315	Peachblow. Delicate peach with yellow....	.25
320	Pink Domino. Soft rose-pink, white throat.	.15
325	Queen Victoria. Pure white ¼ oz. 65c	.15
330	Rose. Brilliant rose-pink ¼ oz. 65c	.15
336	Torchlight. Orange, yellow lip... ¼ oz. 65c	.15
338	Collection 8 varieties	1.00

SEMI-DWARF VARIETIES, 15 to 18 in.

340	Art Shades. Ranging through pink, orange and terra cotta. 1 ft. ¼ oz. 75c	.15
345	Amber Queen ¼ oz., 75c	.15
347	Beacon. Beautiful salmon-rose20
355	Cottage Maid. Pale coral-pink, white throat	¼ oz. 60c .15
360	Crimson Empress ¼ oz. 75c	.15
365	Golden Queen. Pure yellow ¼ oz. \$1.00	.15
373	Matchless. Apricot-buff, yellow center15
374	Pink Queen. Wild rose pink.... ¼ oz. 75c	.15
375	Purity. Pure white ¼ oz. 85c	.15
377	Rose Dore. Salmon-rose, shaded gold....	.15
380	Mixed. Finest varieties ¼ oz. 50c	.10
385	Collection of 8 Varieties. Our selection....	1.00

TOM THUMB VARIETIES, 8 to 10 in.

Excellent for bedding, blooming all Summer.

395	Brilliant Crimson ¼ oz. 85c	.15
400	Bronze and Gold ¼ oz. 85c	.15
405	Canary Yellow ¼ oz. 85c	.15
410	Dark Scarlet ¼ oz. 85c	.15
412	Pinkie. Bright rosy pink.... ¼ oz. 85c	.15
415	Snowflake. Extra pure white.... ¼ oz. 85c	.15
420	Choice Mixed ¼ oz. 85c	.15
425	Collection of 6 Varieties75

ANTIRRHINUM FOR GREENHOUSE

	Afterglow. Bronze	\$1.00
	Bertha Baur. Lavender	1.00
	Ceylon Court. Improved yellow	1.00
	Cheviot Maid Supreme. Dark rose-pink ..	1.00
	Cincinnati. Light rose-pink	1.00
	Claudespy. White	1.00
	Lucky Strike. New white	1.00
	New Dawn. Golden bronze	1.00
	Radiance. Clear pink	1.00
	Rose Queen	1.00
	Sunshine. Deep yellow	1.00
	Terry's Surprise. Bronzy pink	1.00
	Velvet Beauty. American Beauty red	1.00
	Weld Pink	1.00
	White Prosperity	1.00
	White Rock	1.00
	Winter Helen. Salmon	1.00

AQUILEGIA (Columbine). Beautiful, free-flowering, hardy perennials, blooming profusely through the spring and early summer and of easiest cultivation. 1½ to 3 ft.

AQUILEGIA—Continued.

No.		Pkt.
430	Grey's Columbia Hybrids. Special long-spurred strain. The colors include the most charming combinations from the brightest to the most delicate tints.... ¼ oz. \$1.50, ¼ oz. \$2.50	\$0.50
435	canadensis. Scarlet and yellow.. ¼ oz. 75c	.15
440	chrysantha. Bright yellow ¼ oz. 75c	.15
445	chrysantha grandiflora alba .. ¼ oz. \$1.00	.25
450	coerulea (Rocky Mountain Columbine). Splendid, large, light blue ... ¼ oz. \$1.00	.25
460	coerulea, Rose Queen. Long spurs25
461	Crimson Star. Crimson with white corolla.	.25
462	Dobbie's Imperial Hybrids. ¼ oz. \$1.50	.50
465	glandulosa. Deep blue, with white center..	.25
465a	Longissima. A beautiful delicate pale yellow variety with very long spurs, 4 in. or more in length50
466	Long-spurred Pink Shades ¼ oz. \$1.50	.25
467	Mrs. Scott Elliott's Strain ¼ oz. \$1.50	.50
475	olympica. Large delicate mauve.. ¼ oz. 75c	.15
478	Orange and Scarlet Shades, Long Spurred.	.25
480	skinneri. Scarlet and yellow. ... ¼ oz. \$1.50	.25
482	Snow Queen, Long Spurred. ... ¼ oz. \$1.50	.25
485	Mixed Single Varieties ¼ oz. \$1.00	.10
490	Mixed Double Varieties ¼ oz. \$1.50	.25
500	ARABIS alpina. Hardy perennial, with pure white flowers blooming early in the Spring; valuable for edgings and rock-work	¼ oz. 50c .10
505	grandiflora superba. Improved, large flowers. 1 ft. ¼ oz. \$1.25	.15
515	ARCTOTIS grandis. Handsome annual from South Africa, with large, daisy-like flowers, white, with light blue center, the under-side of petals being pale blue. 2 ft. ¼ oz. 75c	.15



Grey's Columbia Hybrid Aquilegia

No.		Pkt.
520	ARGEMONE grandiflora. Annual. Large pure white poppy-like flowers; golden yellow center. 2 ft ¼ oz. 50c \$0.10	
	AEMERIA (Thrift, or Sea Pink). Pretty, hardy perennial for edgings, blooming all summer; tufted flowers.	
525	formosa. Deep rose. 1 ft. ¼ oz. 60c .10	
535	ASCLEPIAS tuberosa. One of the most showy of our summer and autumn flowering, hardy perennials, the umbels of bright, orange-colored flowers. 1½ ft.... ¼ oz., \$2.00 .25	
540	ASPARAGUS plumosus nanus. Beautiful house plants; the feathery foliage is unrivaled for cutting.....100 seeds, \$1.25 .25	
545	sprengeri. Excellent plant for table decorations or to grow in pots or baskets... ¼ oz. 35c .25	

No.		Pkt.
550	ASPERULA azurea setosa. Annual species of Woodruff, with fragrant, light blue flowers, blooming through the Summer and fine for cutting. It will grow in poor soil or in shaded places. 1 ft. ¼ oz. 50c \$0.15	
555	odorata (Sweet Woodruff). Hardy perennial, conspicuous in May by its pure white, sweet-scented flowers. The foliage and flowers when dried retain their fragrance. Grows well under trees.... ¼ oz. 85c .15	
	ASPHODELUS. Showy plants with handsome flower spikes. They grow well in any soil. Hardy perennial.	
570	luteus. Fine, yellow, fragrant. 3 ft. ¼ oz. \$1.00 .15	

Asters

NOTICE: Varieties marked with asterisk (*) are wilt-resisting.

No.		Pkt.
575	COLUMBIA PRIZE. Double Mixed. This mixture is especially selected from the finest large flowering, double varieties, which grow about the same height, and includes the best of recent introductions. It is without an equal ¼ oz. \$1.25, oz. \$4.00, \$0.15	
	AMERICAN BRANCHING, "LATE." Superb free flowering strain, with long, strong stems and very large, graceful chrysanthemum-like flowers, double to the center. By successive sowings they may be had in bloom from Aug. to late fall. 2 to 2½ ft.	
585*	Lavender ¼ oz. \$1.00, oz. \$3.00 .10	
590*	Peerless Pink. Delicate. ¼ oz. 1.00, oz. 3.00 .10	
595*	Purple ¼ oz. 1.00, oz. 3.00 .10	
600*	Rich Crimson ¼ oz. 1.00, oz. 3.00 .10	
605*	Rose Pink ¼ oz. 1.00, oz. 3.00 .10	
610*	Shell Pink ¼ oz. 1.00, oz. 3.00 .10	
615*	Snow White ¼ oz. 1.00, oz. 3.00 .10	
620*	Mixed. All colors..... ¼ oz. 1.00, oz. 3.00 .10	
625*	Collection of Six Colors. Our selection..... .50	

No.		Pkt.
	KING. Distinct from every other variety in the character of its flowers, which are of great size and substance, lasting longer when cut than any other class; the long, narrow petals are folded lengthwise, giving somewhat of a quilled appearance. The stems are exceptionally long and strong. They bloom with the late branching. 2 to 2½ ft.	
630	Crimson. Rich crimson..... ¼ oz. 85c \$0.15	
635	Lavender. Soft lavender-pink ¼ oz. 85c .15	
638	Peach Blossom ¼ oz. 85c .15	
640	Rose. Bright, deep rose ¼ oz. 85c .15	
645	White. Snow-white ¼ oz. 85c .15	
650	Violet. Rich violet-purple ¼ oz. 85c .15	
652	Mixed ¼ oz. 75c .15	
	ROYAL. A new class, with broad, incurved petals, possessing all the characteristics of the late branching, as to size of flower, vigor of plant, etc., but not quite so tall; they bloom earlier and are classed with the midseason varieties. 1½ to 2 ft.	
660*	Dark Lavender ¼ oz. 75c .15	
662*	Lavender-Pink ¼ oz. 75c .15	
665*	Purple. Rich, deep purple ¼ oz. 75c .15	
666*	Rose ¼ oz. 75c .15	
670*	Shell-Pink ¼ oz. 75c .15	
675*	White. Glistening white ¼ oz. 75c .15	
678*	Mixed ¼ oz. 75c .15	
	DOUBLE CALIFORNIA GIANTS. A variety of Aster of the improved Comet type. Very strong stems. Petals beautifully curved and twisted. 3 ft.	
680	Collection of 5 colors, separate 1.00	
685	Dark Purple ¼ oz. 85c .25	
690	Deep Rose ¼ oz. 85c .25	
692	El Monte. New Super Giant. Flowers deep glowing crimson, large and fluffy, borne on heavy, non-lateral, basal-branched stems. Early blooming25	
695	Light Blue ¼ oz. 85c .25	
698	Los Angeles. New Super Giant Shell Pink.. ¼ oz. \$1.00 .25	
700	Peach Blossom ¼ oz. 85c .25	
705	White ¼ oz. 85c .25	
710	Mixed ¼ oz. 85c .25	

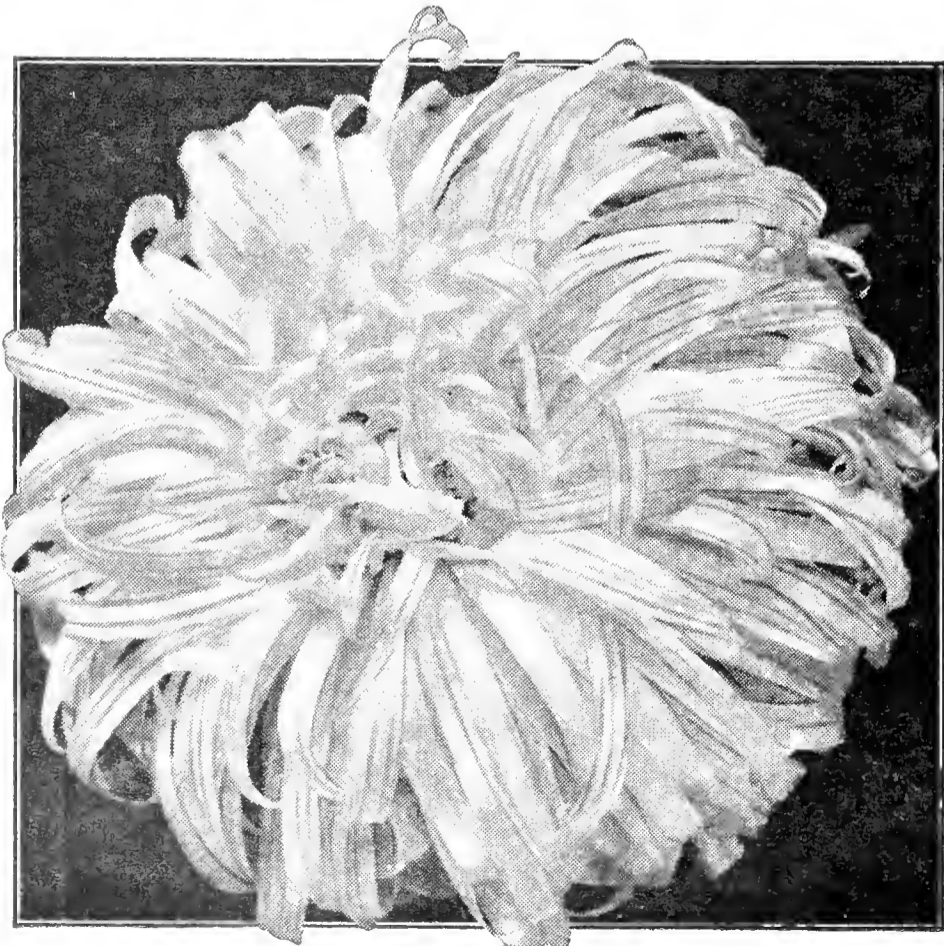

American Late Branching Aster

SEE PAGE 4 FOR SEEDS OF PLANTS SUITABLE FOR ROCK GARDEN



Crego's Giant Comet Asters

ASTERS—Continued.

No.		Pkt.
	CREGO'S GIANT COMET. Branching sort with large, full, fluffy flowers—through August and September. 2½ ft.	
711*	Azure-Blue 1/8 oz. 75c	\$0.15
712*	Crimson 1/8 oz. 75c	.15
715	Lavender 1/8 oz. 75c	.15
716	Egyptian Rose. Deep cinnabar... 1/8 oz. 75c	.15
720*	Purple. Fine color..... 1/8 oz. 75c	.15
725*	Pink. Soft shell-pink 1/8 oz. 75c	.15
730*	Rose. Clear, bright rose 1/8 oz. 75c	.15
734	Venus. New silvery salmonpink. 1/8 oz. \$1.00	.20
735*	White. Pure snow white..... 1/8 oz. 75c	.15
736	Mixed 1/8 oz. 75c	.15
	OSTRICH PLUME, Improved. Enormous flowers on long stems. The petals are curled and twisted, blooming in August and September. 2½ ft.	
740	Collection of following 6 colors, separate. .75	
745*	Crimson 1/8 oz. 75c	.15
750*	Dark Purple 1/8 oz. 75c	.15
755*	Lavender 1/8 oz. 75c	.15
760*	Rose Pink 1/8 oz. 75c	.15
765*	White 1/8 oz. 75c	.15
770*	Shell-Pink 1/8 oz. 75c	.15
775*	Finest Mixed 1/8 oz. 75c	.15
800	Lilliput Flowered Mixed. Plants 14-16 in. bearing an abundance of small button-like flowers. 1/8 oz. 85c	.15
810	BLUE FLAME. Bright navy-blue flowers. Plant of the Comet type, 2½ ft. high and wilt-resistant 1/8 oz. 75c	.25
820	EDELWEISS. Very dwarf and compact with semi-double, snow-white flowers 1/8 oz. 75c	.25
825	GOLDEN SHEAF. Wilt-resistant, 2 feet. Aurora type of Aster with fully double deep yellow flowers with crest-like center, of good substance and fine depth of petal 1/8 oz. 85c	.25
830	IMBRICATED POMPON MIXED. Plants of upright habit, 14-16 inches high with small, round, pompon flowers. Very early 1/8 oz. 75c	.15
835	MASSAGNO WHITE (Tokio). Pure white flowers with narrow, partly quilled petals 1/8 oz. 85c	.25

RECORD. Large flowering ray type. 2 feet. Fine for cut flowers.

No.		Pkt.
840	Bright Rose	\$0.15
850	Violet15
845	Lilac15
855	White15

UNICUM. 2 ft. long, narrow curled petals.

870	Deep Lilac15
875	Light Blue15
880	Rose15
885	White15

QUEEN OF THE MARKET. The earliest flowering, first class Aster, coming into bloom 3 to 4 weeks earlier than other sorts. The flowers are of good size on long stems and extensively grown for cutting. 1½ ft.

895	Collection of the following 6 colors	\$0.50
900*	Crimson 1/4 oz. 75c, oz. \$2.00	.10
905*	Dark Blue 1/4 oz. 75c, oz. 2.00	.10
910*	Flesh-Pink 1/4 oz. 75c, oz. 2.00	.10
915*	Light Blue 1/4 oz. 75c, oz. 2.00	.10
920	Rose 1/4 oz. 75c, oz. 2.00	.10
925*	White 1/4 oz. 75c, oz. 2.00	.10
930	Mixed. All colors 1/4 oz. 75c, oz. 2.00	.10

EARLY AMERICAN BEAUTY. A fine, strong growing Aster with incurved petals. Blooms from July to frost. 2½ to 3 ft.

945*	Azure Fairy 1/8 oz. 75c	.20
948*	Crimson 1/8 oz. 75c	.20
950	Peach Blossom 1/8 oz. 75c	.20
955*	Purple 1/8 oz. 75c	.20
960*	Rose 1/8 oz. 75c	.20
965*	Shell-Pink 1/8 oz. 75c	.20
970*	White 1/8 oz. 75c	.20
975*	Mixed 1/8 oz. 75c	.20

OTHER ASTERS

976*	Ball Purple Early. Deep bright purple.... 1/8 oz. 85c	.20
977*	Ball White Early. Branching 1/8 oz. 85c	.20
978*	Heart of France. A pure red Aster. Very double, of strong, branching habit. It keeps its brilliant rich color when cut.. 1/8 oz. 75c	.15
980	Surprise Salmon Gold. Pure salmon-yellow, turning to a radiating salmon-pink. .25	

SINGLE GIANTS OF CALIFORNIA. Flowers 3 to 4 inches across with stems 1½ to 2 feet in length. The petals are slightly twisted.

981	Light Blue 1/8 oz. 60c	.15
991	Purple 1/8 oz. 60c	.15
996	Rose 1/8 oz. 60c	.15
1001	White 1/8 oz. 60c	.15
1006	Finest Mixed 1/8 oz. 60c	.15

CALIFORNIA SINGLE GIANT IMPROVED "SUNSHINE." Crested flowers with golden centers; strong growing, with flower stems 2 ft. and over in length.

1011	Delicate Flesh Pink. 1/8 oz. 85c	.20
1012	Lavender 1/8 oz. 85c	.20
1015	Rose Pink 1/8 oz. 85c	.20
1016	Violet 1/8 oz. 85c	.20
1017	White 1/8 oz. 85c	.20
1018	Mixed 1/8 oz. 85c	.20

SINGLE ASTER ELEGANCE.

1028*	General Joffre. Large single aster of intense crimson-scarlet, on long stems. Excellent for cutting 1/8 oz. 75c	.15
-------	---	-----

SOUTHCOTE BEAUTY SINGLE. 2 ft.

1030	Dark Blue20
1032	Mauve20
1035	Rose20
1038	Scarlet20
1040	White20
1045	Mixed20
1048	Collection 5 colors.....	.75

No.		Pkt.	No.		Pkt.
	ASTER, Perennial Sorts (Michaelmas Daisies). We have in this class some of the most beautiful and interesting hardy plants grown; their graceful habit, profusion of bloom and variety of color form the chief attraction of the flower garden during the autumn months.		1115	BAPTISIA australis (False Indigo). Handsome hardy perennial, producing bright blue, pea-shaped flowers on spikes 6 inches long. 2½ ft. ¼ oz. \$1.00	\$0.15
1050	alpinus speciosus . Large, rich purple....	\$0.25	1120	BARTONIA aurea . Showy, hardy annual of distinct character, its large golden yellow flowers being freely produced; succeeds well in partial shade. 1½ ft. ¼ oz. 50c	.15
1055	subcoeruleus, Wartburg Star . Extra large, bright lavender-blue, yellow centers. Flowers 4 inches across, long stems. Extra early. 2 ft.25		BEANS, Flowering.	
1060	White Queen . Large white25	1125	Butterfly Runner . Large pink and white. ¼ lb. 50c; lb. \$1.50	.15
1065	Mixed Hybrids, New Large-Flowered Strain . 2 to 4 ft. ¼ oz. \$1.75	.25	1130	Scarlet Runner . Large, brilliant scarlet. Lb. 50c	.10
	AUBRIETIA . These dwarf, hardy perennials are invaluable for the border, rockeries, etc.; they are among the brightest and most free flowering plants of early spring.		1135	White Runner . Large, pure white. Lb. 50c	.10
1070	graeca . Beautiful purple color25		BEGONIA, Tuberous-rooted . These are easily grown from seed and may be had in bloom in about 6 months. They make a gorgeous display throughout the season and are excellent for bedding purposes, window boxes, etc., and as pot plants are effective for house and conservatory. 1 ft.	
1075	leichtlini . Rosy red, very pretty25	1140	Double, Prize Mixed	\$1.00
	AURICULA . See <i>Primula auricula</i> .		1142	Blackmore & Langdon's Double Mixed ...	1.00
	BACHELOR BUTTON . See <i>Centaurea</i> .		1145	Single, Giant Mixed50
	BALSAM . These old-fashioned annuals, so easily grown, are again increasing in popularity, and most beautiful and brilliant effects may be had from them; overcrowding should be avoided and they should be set at least 18 inches apart for best results.		1147	Blackmore & Langdon's Single Mixed ...	1.00
1080	Columbia Prize . An unsurpassed strain in doubleness, size, brilliancy and variety of color	¼ oz. 75c .15	1150	Single Fringed . Unsurpassed strain50
1085	Dark Blood Red . Extra	¼ oz. 50c .10	1152	Blackmore & Langdon's Extra Frilled Mixed	1.00
1090	Intense Scarlet (The King) ...	¼ oz. 50c .10	1154	Blackmore & Langdon's Basket Begonia Mixed	1.00
1095	Rich Pink (Salmon King)	¼ oz. 50c .10		BEGONIA, Fibrous-rooted . The following sorts are perpetual bloomers and extensively used for planting outside in beds and for pot culture in the greenhouse. 1 ft.	
1100	White (Snowball). Superior	¼ oz. 50c .10	1155	gracilis, White Pearl . Pure white.....	.25
1105	Mixed Rose-flowered . Very double	¼ oz. 40c .10	1160	Bonfire . Lustrous carmine, with brownish red foliage25
1110	BALLOON VINE . A rapid growing annual climber, with white flowers and inflated seed vessels which look like miniature balloons	oz. 50c .10	1165	Mignon . Brilliant salmon-scarlet. 8 in.	.25
			1170	luminosa . Dark scarlet, foliage deep..	.25
			1172	Prima Donna . Rose, carmine shaded..	.25
			1175	rosea . Fine rose-pink25

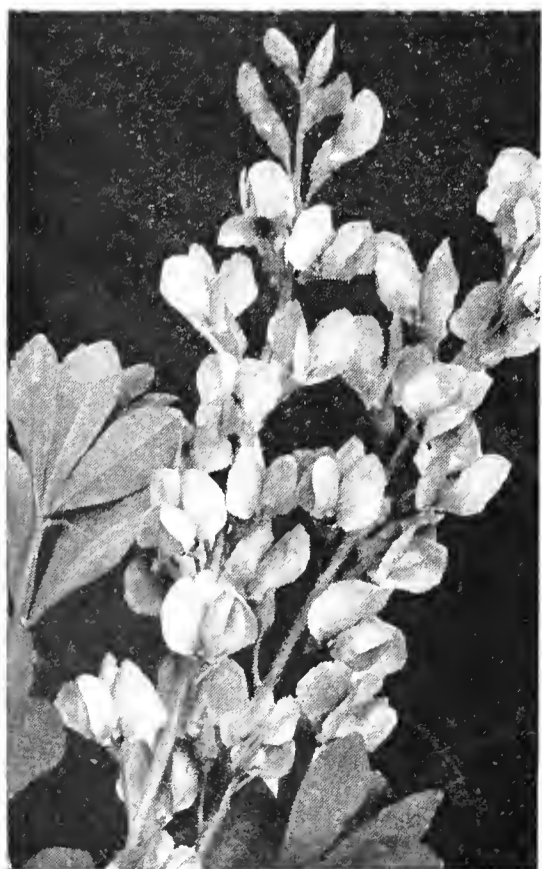

Baptisia australis



Double Tuberous Begonia



Balsam

BEGONIA—Continued

No.		Pkt.
1180	erfordi, Glory of Erfurt. Lovely rose-carmine flowers, with dark, glossy, green foliage	\$0.50
1185	Salmon Queen. Brilliant salmon-red, passing to salmon-rose; the dark green foliage has a reddish hue50
1190	Triumph. Beautiful, large, snow white flowers; excellent50
1195	Vernon. Deep scarlet, with bronze foliage.25
1200	Vernon, Dwarf. Rich red, with glossy bronze foliage. 8 in.25
1205	Rex varieties, Mixed (Ornamental leaved). Large handsome variegated leaves75
1208	Semperflorens, Gustave Knaake. Glowing salmon-pink, leaves green. Excellent for pot culture35
BELLIS perennis fl. pl. (Double Daisy). Favorite perennials producing in Spring their handsome, double flowers, and are very effective when planted with Pansies or Forget-me-nots. Rich soil and cool situation suit them best.		
1220	monstrosa, Rose. Extra large, 1/8 oz. \$1.50	.25
1225	monstrosa, White. Extra large. 1/8 oz. \$1.50	.25
1230	Quilled, Giant Red. Dark red25
1235	Quilled, Giant White. Pure white25
1240	monstrosa, Finest Mixed. Double..... 1/8 oz. \$1.00	.15

1245	BOCCONIA japonica (Plume Poppy, or Tree Celandine). 5 ft. Ornamental, hardy perennial, with glaucous green foliage and spikes of creamy white flowers, 2 to 3 feet long. 1/4 oz. 60c	.15
------	--	-----

1250	BOLTONIA latisquama. One of our showiest hardy perennials, with large clusters of lavender-pink, Daisy-like flowers. 5 ft.25
------	--	-----

BROWALLIA. Beautiful, profuse blooming bedding and pot plants. 1 1/2 to 2 ft.

1255	speciosa major. Large, brilliant, ultramarine blue; splendid winter bloomer.35
1256	speciosa alba. Same habit as above50
1260	Mixed Elata. Shades of blue and white.. 1/4 oz. 50c	.15

1265	BUPHTHALMUM Speciosus (Ox-Eye). Fine, hardy perennial, with large, golden yellow flowers on long stems, 5 ft... 1/4 oz. 85c	.15
------	--	-----

BRACHYCOME (Swan River Daisy). Profuse flowering, low growing annual, with pretty Daisy-like flowers; doing best in warm and dry situations. 9 in.

1270	Blue Star. Beautiful bright blue. 1/8 oz. 50c	.15
1275	rosea. Fine color	1/4 oz. 75c .15
1280	Mixed.	1/4 oz. 50c .10

1285	CACALIA coccinea (Tassel Flower). A neat, free blooming annual, with scarlet tassel-like flowers. All summer. 1 1/2 ft. 1/4 oz. 35c	.10
------	---	-----

1290	CACTUS. Succulent plants. Excellent mixture of American grown varieties, suitable for growing in pots in house or conservatory25
------	---	-----

CALCEOLARIA. Our seeds are from noted English growers and saved from the finest strains grown, which have been awarded the leading prizes.



Calendula

CALCEOLARIA—Continued

No.		Pkt.
1295	Covent Garden Strain. Extra choice, strongly recommended for habit, size and marketing of flowers	\$0.75
	hybrida multiflora nana. Plants 10-12 in. in height, producing masses of little ball-shaped flowers.	
1296	Deep Crimson. Dark velvety shade; effective contrast to Golden Tiger75
1297	Golden Tiger. Profuse golden yellow flowers with dark brownish red dots75
1298	Splendid Mixed75
1300	KELWAY'S Perfect Model. Medium height. Of splendid habit. Heads of very large flowers. The richest and most delicate colors	1.00
1301	rugosa or Shrubby, Mixed50
1302	Scabiosifolia. Annual, 2 ft. Free flowering with small bright yellow flowers.....	.25
CALENDULA officinalis fl. pl. (Pot Marigold). Valuable, hardy annual, the double showy flowers making a grand display for months; suitable for dry places. 1 1/2 to 2 ft.		
1303	Art Shades. Contains apricots, picotees, orange and cream tones..... 1/4 oz. 40c	.15
1304	Ball's Apricot. Brown centerOz. \$1.50	.15
1306	Ball's Gold. Deep golden	Oz. \$1.50 .15
1307	Ball's Orange. Light center	Oz. \$1.50 .15
1308	Campfire (Sensation). Dark orange. Light center	1/4 oz. 60c .15
1309	Chrysantha. Chrysanthemum-flowered type with petals long and wide, of clear buttercup-yellow25
1309a	Frilled Beauty. Deep orange frilled petals.	.15
1310	Lemon Queen. Lemon yellow	Oz. 50c .10
1312	Masterpiece. Deep orange, brown center.	.15
1315	Meteor. Lemon, striped orange.Oz. 50c	.10
1320	Orange King. Large, dark orange. ..Oz. 75c	.10
1325	Orange Shaggy. Long, deeply fringed petals25
1328	Radio. Deep orange, quilled10
1330	Mixed. Double all shades	Oz. 35c .10



Calliopsis drummondii

No.		Pkt.
	CALIFORNIA POPPY. (See Eschscholtzia.)	
	CALLIOPSIS, or COREOPSIS. Showy, hardy annuals, very continuous in flowering, and most useful for cutting.	
1335	coronata maxima. Large yellow. ¼ oz. 40c	\$0.10
1340	drummondii (Golden Wave). Golden yellow, with brown center ¼ oz. 40c	.10
1345	Fire King. Deep, bright scarlet, cactus-shaped petals15
1351	Garnet. 1 ft. Dwarf glossy crimson-scarlet15
1352	Golden Ray. 10 in. Gold, maroon center..	.15
1353	Star of Fire. 10 in. Garnet-brown15
1354	Tiger Star. 10 in. Bright yellow and maroon15
1355	Mixed. Fine varieties.. ¼ oz. 25c,	oz. 75c .10
	CALLIOPSIS, or COREOPSIS. Hardy Perennial Varieties. Early sown seed will bloom the same season, but it is better to sow in July and protect lightly in winter.	
1365	Mayfield Giant. California strain. Large golden yellow flowers .. ¼ oz. \$1.00	.25
1370	grandiflora. Golden yellow ¼ oz. 50c	.10
1375	lanceolata. Large, bright yellow..... ¼ oz. 60c	.15
1380	CALLIRHOE involucrata (Poppy Mallow). Showy, hardy perennial of spreading growth, with large, bright crimson, saucer-shaped flowers from early summer till fall. 1 ft. ¼ oz. 60c	.15
	CAMPANULA (Bellflower). Beautiful well-known hardy perennial and one of our most attractive garden flowers, noted for their rich colors and profusion of bloom.	
1385	carpatica. Erect blue flowers all Summer; useful for borders or rockery. 9 in. ¼ oz. \$1.00	.15
1390	carpatica alba. Erect, white flowers. 9 in. ¼ oz. \$1.00	.15
1394	lactiflora coerulea. Tall, light blue25

No.		Pkt.
1395	mirabilis. Large, pale blue; extra. 2 ft.	\$0.50
1400	moerheimi. Large, white, saucer-shaped flowers. 2 ft. ¼ oz. \$1.50	.25
1405	persicifolia grandiflora. Large, bright blue; one of the best. 2 ft. .. ¼ oz. 85c	.25
1410	persicifolia grandiflora alba. Large, pure white. 2 ft. ¼ oz. 85c	.25
1415	persicifolia grandiflora pfitzeri. Large, light blue, double and semi-double25
1418	persicifolia grandiflora. Telham Beauty. Largest blooms of soft lavender 2½ ft.	.50
1420	persicifolia grandiflora. Mixed.25
1425	pyramidalis (Chimney Bellflower). Blue. 4 ft. ¼ oz. 60c	.15
1430	alba. White. 4 ft. ¼ oz. 75c	.15
1433	compacta, Mixed15

Canterbury Bells

Annual Varieties. Plant grows from 2 to 2½ feet high, each plant having from 6 to 8 spikes of blooms. Seeds planted in February bloom in July.

1436	Angelus Bell. Deep rose15
1437	Liberty Bell. Violet-blue15
1438	Wedding Bell. Pure white15
1439	Mixed15

CAMPANULA medium (Canterbury-bells). Showy, hardy biennials, about 3 ft. high, of pyramidal form, and profusely covered with large, bell-shaped flowers. **calycanthema** (Cup-and-saucer Varieties).

1440	Blue	¼ oz. \$1.00 .15
1445	Rose Pink	¼ oz. \$1.00 .15
1450	White	¼ oz. \$1.00 .15
1455	Mixed. All colors	¼ oz. \$1.00 .15
1457	Double Mixed35
1460	Single, Blue	¼ oz. 50c .10
1465	Rose Pink	¼ oz. 50c .10
1475	Mauve	¼ oz. 50c .10
1480	White	¼ oz. 50c .10
1485	Mixed. All colors	¼ oz. 50c .10
1490	Double, Blue	¼ oz. \$1.00 .15
1495	Rose Pink	¼ oz. \$1.00 .15
1500	White	¼ oz. \$1.00 .15
1505	Mixed. All colors	¼ oz. \$1.00 .15
1510	Columbia Prize Mixture. All colors of all varieties, unsurpassed ¼ oz. \$1.00	.25

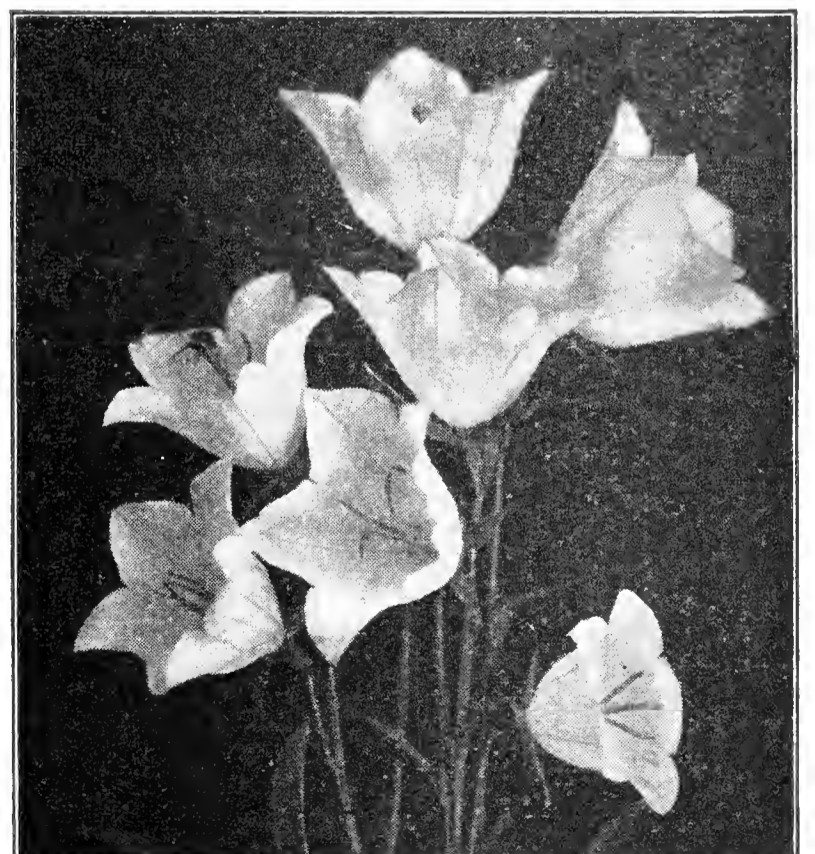

Campanula persicifolia

CAMPANULA—Continued

No.		Pkt.
1512	Dwarf Bedding Mixed. New type about 20 inches in height, forming bushes over 3 feet in circumference, often bearing 100-150 flowers. Mixed colors only, containing various shades of blue, mauve and white. Biennial.....	\$0.25
	CANDYTUFT. Fine for edgings and cut flowers. Hardy annual. 1 ft.	
1515	Carmine. Carmine-rose 1/4 oz. 40c, oz. \$1.50	.15
1520	Crimson 1/4 oz. 25c, oz. 75c	.15
1525	Dobbles White Spiral. A superior strain of the large flowered white from the introducer 1/4 oz. 50c, oz. \$1.50	.10
1530	Empress. Immense, pure white, pyramidal trusses 1/4 oz. 35c, oz. \$1.00	.10
1532	Flesh Pink 1/4 oz. 40c	.10
1535	Giant Perfection. Immense, pure white spikes. 'Special selection 1/4 oz. 60c, oz. \$2.00	.15
1536	Lavender 1/4 oz. 20c, oz. 50c	.10
1537	Pyramidal Perfection. Very large, white, fine for greenhouses 1/4 oz. 60c	.15
1542	Rose Cardinal 1/4 oz. 50c	.15
1545	Mixed. All colors 1/4 oz. 15c, oz. 40c	.10
1550	Dwarf Rose 1/4 oz. 60c, oz. \$1.75	.15
1555	White 1/4 oz. 60c, oz. \$1.75	.15
1556	Flesh Pink 1/4 oz. 60c	.15
1558	Crimson 1/4 oz. 60c	.15
1560	Mixed Hybrids 1/4 oz. 50c, oz. \$1.50	.10
	CANNAS Handsome foliage. Soak the seed in hot water 24 hours before sowing. 3 to 4 ft.	
1565	Crozy's New Large-Flowering Varieties Newest and best sorts Oz. 60c	.10
	CARDINAL CLIMBER. See <i>Ipomoea Quamoclit.</i>	
	CARNATION PINKS. See <i>Dianthus.</i>	
	CASTOR OIL BEANS. See <i>Ricinus.</i>	
	CATCHFLY. See <i>Silene.</i>	
	CELOSIA cristata, or COCKSCOMB. Free blooming annuals; large, brilliant Cockscomb-like heads. They prefer a light soil, not too rich; fine border or pot plant.	
1575	Collection 5 following colors, separate	.60
1580	Dwarf Bright Rose. 3/4 ft. .. 1/8 oz. \$1.00	.15
1585	Copper Color. 3/4 ft. 1/8 oz. \$1.00	.15
1590	Dark blood Red. 3/4 ft. 1/8 oz. \$1.00	.15
1595	Glasgow Prize. Dark crimson. 3/4 ft. 1/8 oz. \$1.25	.15
1600	Golden Yellow. 3/4 ft. 1/8 oz. \$1.25	.15
1610	Mixed. Finest colors. 3/4 ft. 1/8 oz. 75c	.10
1615	Tall Mixed. All colors. 2 to 3 ft. 1/2 oz. 20c	.10
	CELOSIA thompsoni magnifica, Improved Feathered Cockscomb. A magnificent and valuable annual, with long, feathery plumes of the richest colors, varying from pale yellow to the deepest crimson. Effective during summer and fall. 2 ft.	
1617	childsi (Chinese Woolflower)15
1620	Carmine 1/8 oz. 50c	.15
1625	Crimson 1/8 oz. 50c	.15
1630	Golden Yellow 1/8 oz. 50c	.15
1635	Light Yellow 1/8 oz. 50c	.15
1640	Scarlet 1/8 oz. 50c	.15
1645	Triumph of Exposition. Crimson, dark red stems 1/8 oz. 50c	.15
1650	Mixed. All colors 1/8 oz. 50c	.15
1660	CELSIA arcturus. A fine, half hardy plant, very pretty for pot culture in a cool house. The long spikes of bright yellow flowers are produced the same season from spring sown seed. 1 ft.50
1662	cretica. Large yellow flowers in long spikes. 6 ft. H. H. B.50

No.		Pkt.
	CENTAUREA (Dusty Miller). Silver foliaged plants, extensively used for edgings, baskets, etc. Half-hardy perennial.	
1665	candidissima. Thick foliage. 1 ft. 1/8 oz. 50c	\$0.15
1670	gymnocarpa. Very graceful. 1 1/2 ft. 1/4 oz. 50c	.15
	CENTAUREA, Annual Varieties. Very free flowering, with handsome, showy flowers; useful for cutting. 2 to 2 1/2 ft.	
1675	americana. Reddish lilac. 1/4 oz. 60c	.15
1676	americana alba 1/4 oz. 75c	.20
1678	Cyanus, Dwarf Jubilee Gem. Plants about 1 ft. high, compact and covered with vivid double blue flowers25
1680	Cyanus, Mixed (Bachelor Button) oz. 60c	.10
1685	Double, Mixed oz. \$1.00	.10
1690	Single Blue oz. 50c	.10
1695	Double Blue 1/4 oz. 50c	.15
1696	Double Carmine 1/4 oz. 40c	.15
1697	Double Maroon 1/4 oz. 40c	.15
1698	Double Mauve 1/4 oz. 40c	.15
1700	Double Purple 1/4 oz. 40c	.15
1705	Double Rose 1/4 oz. 40c	.15
1710	Double White 1/4 oz. 40c	.15
	Imperialis (Royal Sweet Sultan). Very large, sweet scented flowers. 2 to 3 ft.	
1715	Bright Pink 1/4 oz. 60c	.15
1720	Dark Purple 1/4 oz. 60c	.15
1725	Deep Lavender 1/4 oz. 60c	.15
1730	Lilac 1/4 oz. 60c	.15
1735	White 1/4 oz. 60c	.15
1740	Mixed, All colors 1/4 oz. 60c	.15
1765	Suaveolens. Yellow Sweet Sultan 1/4 oz. 50c	.15
	CENTAUREA, Perennial Varieties. Desirable, hardy plants, with showy thistle-like flowers from July to September.	
1770	macrocephala. Large yellow. 3 ft.15
1775	montana. Deep purple. 2 ft. .. 1/4 oz. 75c	.15
1780	alba. Large white. 2 ft. 1/4 oz. 75c	.15
1790	CERASTIUM tomentosum (Snow-in-summer). A white foliaged hardy perennial, with small, white flowers; fine for edgings and rockeries. 4 in. 1/8 oz. 75c	.25

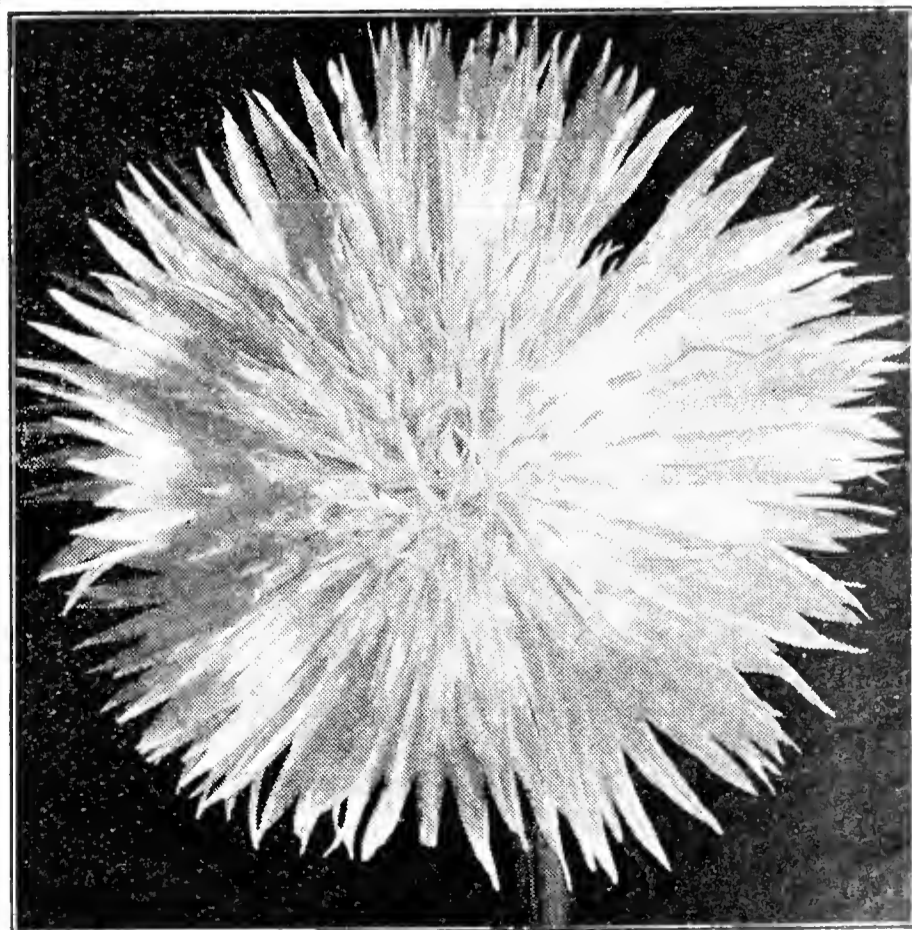

Centaurea Imperialis



No.	Cineraria	Pkt.
1792	CHEIRANTHUS allioni (Siberian Wallflower). Excellent dwarf perennial for rockery or margin of herbaceous border, brilliant orange flowers in spring and all summer if seed pods are removed. 1 ft. ¼ oz. 75c \$0.20	
1794	linifolius (Alpine Wallflower). Dwarf, mauve, fragrant. 1 ft.25	
	CHELONE. Pentstemon-like spikes of brilliant colored flowers from July to October. Hardy perennial. 2 ft.	
1795	barbata torreyi. Scarlet ⅓ oz. 75c .15	
1800	Hybrid, Mixed. Beautiful..... ⅓ oz. 60c .15	
1802	CHORIZANTHE Palmeri (Turkish Rugging). Excellent annual for rock gardens, forming a dense mat of statice-like flowers on dull green foliage15	
	CHRYSANTHEMUM. Showy and effective summer flowering plants, blooming from July until frost; very desirable for the garden and for cut flowers.	
	Double-flowering Annual Varieties. 2 ft.	
1805	Golden yellow ¼ oz. 60c .15	
1808	Scarlet ¼ oz. 60c .15	
1810	White ¼ oz. 60c .15	
1815	Mixed. All colors ¼ oz. 40c .10	
1820	Fringed Hybrids. All colors .. ¼ oz. 50c .15	
	Single-flowering Annual Varieties. 2 ft.	
1825	atrococcineum. Scarlet ¼ oz. 35c .10	
1830	Evening Star. Large golden ¼ oz. 60c .10	
1832	Eastern Star. Primrose-brown disc10	
1833	Golden Glory. Deep golden yellow10	
1835	Morning Star. Large primrose ¼ oz. 60c .10	
1840	Northern Star. Large white, yellow center, with dark disc ¼ oz. 60c .10	
1845	Mixed. All colors Oz. 60c .10	
1850	Grey's Special Mixture. All colors in double, single and fringed. .. ¼ oz. 60c .15	
1852	Cascade, or Balcony. Annual Large clusters of small single flowers. Plant is of the trailing type and attractive in a window box or pot25	
	CHRYSANTHEMUM, Perennial Varieties.	
1855	frutescens (Paris Daisy). Single white, fine for winter blooming. 1½ ft..... .15	
1856	Inodorum, Bridal Robe. Dwarf, compact small double white flowers25	
1860	Mawii. Rich rose pink flowers on a dwarf plant. Ideal for borders or rockeries... .35	
1870	Shasta Daisy, Alaska. One of the best hardy white flowers for cutting; large, single25	
1872	Shasta Daisy, Double White. Semi-double and double fringed35	
1875	Pompon-flowered. The double, small-flowered hardy sorts; fine colors25	

No.		Pkt.
	CINERARIA. One of the most beautiful plants for house or conservatory during the spring months. Seeds should be sown from May to September.	
	multiflora grandiflora maxima. A hybrid between "multiflora nana" and "grandiflora" having blooms of the grandiflora and many flowers of multiflora nana. 12 to 16 inches above the pot.	
1876	Light Rose \$1.00	
1877	Salmon-Rose 1.00	
1878	Carmine 1.00	
1879	Dark Red 1.00	
1881	Cornflower Blue 1.00	
1882	Marine Blue 1.00	
1883	White 1.00	
1884	Mixed 1.00	
1885	Grey's Exhibition Prize. Acknowledged by our customers to be the finest strain grown; of compact branching habit, with exceptionally large flowers of the richest and brightest colors. 1.00	
1886	Cremer's Prize Strain Mixed 1.00	
1888	grandiflora alba. Large pure white75	
1890	atrosanguinea. Large blood red75	
1895	azurea. Large, light blue75	
1898	Dark Blue75	
1900	kermesina. Large, bright crimson75	
1902	Matador. Glowing scarlet75	
1905	Pink shades. Very fine75	
1910	Dwarf Large-flowering Mixed. Dwarf, compact habit with immense trusses of large flowers in rich colors75	
	multiflora nana. A new Cineraria created by a Swiss florist. Makes a beautiful pot plant. Very compact growth, 10 in. above the pot. Leaves rather smaller than the grandiflora type of Cineraria. Flowers slightly more than 1 inch in diameter with centers varying from yellow to brown.	
1911	Dark Blue75	
1912	Deep Red75	
1913	Lavender75	
1914	Light Blue75	
1915	Pure White75	
1916	Pink75	
1917	Rose75	
1918	Mixed75	
1919	stellata, Feltham Beauty. Extra mixed... .75	
1920	stella grandiflora. Large flowers, with twisted or fluted petals75	
1925	maritima candidissima, Diamond (Dusty Miller). White foliage ¼ oz. 35c .15	
	CLARKIA. Very showy and profuse flowering hardy annuals of easy culture; very useful for cutting. 2 ft.	
1928	Double Appleblossom ¼ oz. 50c .15	
1930	Brilliant. Bright orange ¼ oz. 50c .15	
1931	Crimson Queen ¼ oz. 60c .20	
1932	Enchantress. Orange shading to pink.. ¼ oz. 50c. .15	
1935	Orange King. Orange-scarlet.. ¼ oz. 50c .15	
1940	Purple Prince. Rich purple.. ¼ oz. 50c .15	
1945	Queen Mary. Rose-carmine .. ¼ oz. 50c .15	
1950	Salmon Queen. Salmon-pink ¼ oz. 50c .15	
1952	White ¼ oz. 50c .15	
1955	Mixed. Extra fine colors.... ¼ oz. 25c .10	
	CLEMATIS. Well known as valuable, hardy, profuse flowering, climbing perennials.	
1965	Jackman's New Hybrids ... ¼ oz. \$1.00 .25	
1970	paniculata. Covered with a cloud of star-like, fragrant white flowers.. ¼ oz. 35c .10	
1975	CLEOME pungens (Spiderflower). Flowers rose with long stamens ¼ oz. 75c .15	
1976	alba. White ⅓ oz. 50c .15	
1980	CLIANTHUS dampieri (Glory Pea). A magnificent greenhouse annual, with large brilliant scarlet, pea-shaped flowers having a black center25	



Double Crested Cosmos

No.		Pkt.
1985	COBAEA scandens. Popular climber of rapid growth, with large, purple, bell-shaped flowers; blooms first season from seed which should be planted edgewise. 20 ft... ¼ oz. 30c, oz. \$1.00	\$0.15
1990	scandens alba. White flowered.....	.25
1993	Mixed. ¼ oz. 30c, oz. \$1.00	.10
	COCKSCOMB. See <i>Celosia</i> .	
	COLEUS. Ornamental foliage plants, easily grown from seed. Half hardy perennial.	
2005	Mixed Hybrids. From a large collection..	.15
2010	New Large-leaved Varieties. Extra fine...	.25
2015	COLLINSIA, Mixed. Free flowering, hardy annuals suited to dry situations.... ¼ oz. 20c	.10
2020	COMMELINA coelestis. Half hardy tuberous-rooted perennial, with sky-blue flowers; blooms first season. 1½ ft.....	.15
2025	CONVOLVULUS minor, Mixed. Handsome, hardy annual, with large, richly colored flowers, producing a brilliant effect. 1 ft. Oz. 40c	.10
	major. See <i>Ipomoea</i> .	
	COSMOS. One of the most beautiful and useful of the hardy annuals, producing through the season thousands of beautiful flowers. Seed should be sown in May in the open ground. The early varieties will bloom from July till frost. 4 to 6 ft.	
	Double Crested. Early blooming.	
2026	Carnelia. Crimson ¼ oz. \$1.00	.25
2027	Peach Blossom. Pink ¼ oz. 1.00	.25
2028	Whirlwind. White ¼ oz. 1.00	.25
2029	Finest Mixed ¼ oz. 1.00	.25
2030	Extra Early, Mammoth Midsummer, Mixed. The blossoms, under ordinary field cultivation, average 4 to 5 inches across, surpassing in size any of the late varieties ¼ oz. 85c	.15
	From seed sown in the open ground, the White blossoms in 60 days, Pink in 65 and the Crimson in 70 days.	
2035	White. 4 ft..... ¼ oz. 75c, oz. \$2.50	.15
2040	Pink. 4 ft..... ¼ oz. 75c, oz. \$2.50	.15
2045	Crimson. 4 ft. ¼ oz. 75c, oz. \$2.50	.15

COSMOS—Continued.

No.		Pkt.
2050	Sensation. Early Mammoth Flowering Mixed. Flowers from 4-6 inches across. Blooms 10 weeks after sowing..... ¼ oz. 85c	\$0.25
	Mammoth. Late flowering. 5 ft.	
2055	Crimson ¼ oz. 50c	.10
2060	Lady Lenox. Shell-pink..... ¼ oz. 75c	.15
2065	Lady Lenox. White..... ¼ oz. 75c	.15
2070	Klondyke Early Orange Flare. Vivid orange with light green foliage. In bloom in less than 4 months from sowing ... ⅛ oz. 45c	.25
2085	CUPHEA platycentra (Cigar Plant). Bright scarlet, tubular flowers, tipped with black; blooms freely from seed. 1 ft..	.25
	CYCLAMEN. The seed is saved by a leading specialist from selected strains of the very best varieties, and produces flowers of the largest size, finest substance and most charming shades of color. July to August is the best time for sowing. Seedlings should be grown on without any check, and when grown cool the results are more satisfactory.	
2105	Giant America. Imp. Salmon-scarlet....	.75
2110	Blood Red75
2111	Bonfire75
2138	Lavender. Self color, very large.....	1.00
2139	Mozart. New deep pink.....	1.00
2140	Orange Beauty.	1.00
2142	Pink Pearl. Large, pale salmon.....	1.00
2143	Perle of Zehlendorf. Deep salmon.....	.75
2150	Pure Rose. Rich color.....	.75
2152	Rose of Marienthal. Pink, red eye.....	.75
2157	Rose of Zehlendorf. Light salmon.....	.75
2160	Saffron. Red	1.00
2161	Saffron. Silver Edge.	1.00
2162	White75
2165	White, Carmine Eye75
2170	New Ruffled Giants, Mixed	1.00
2180	Grey's Giant Mixture. All colors75
	For above named Cyclamen, 100 seeds \$2.50, 1000 seeds \$18.00	
2182	CYNOGLOSSUM amabile (Chinese Forget-me-not). Annual. Heavenly blue.....	.15
2184	Amabile Pink. Habit same as the above..	.20
2185	CYPERUS alternifolius (Umbrella Plant). Numerous erect stems, supporting in an umbellate manner a quantity of glossy, long, narrow leaves; excellent for house or greenhouse. 1 ft.25
2190	Papyrus (Egyptian Paper Plant). Palm-like foliage; an aquatic or for pots. 5 ft.	.25
	CYPRESS VINE. See <i>Ipomea quamoclit</i> .	
	DAHLIA. This popular flower can be easily raised from seed flowering the same season. Seed should be sown early in gentle heat.	
2192	Cactus, Double Mixed. Saved from a fine collection ¼ oz. \$2.00	.25
2193	Coltness Hybrids. Pink.....	.25
2194	Coltness Hybrids. Scarlet.....	.25
2196	Coltness Hybrids. White.....	.25
2197	Coltness Hybrids. Yellow.....	.25
2198	Coltness Hybrids Mixed. 18-24 in. Single flowers on long stems25
2199	Coltness Mignon. Very dwarf, extra fine bedder. Mixed25
2200	Peony-flowered Giant. Single and semi-double flowers of enormous size, resembling the Peony..... ¼ oz. \$2.00	.25
2205	Pompon, Double Mixed. Small flowered..	.25
2210	Show, Double Mixed. Large flowered....	.25
2215	Single Giant Perfection. Surpassing all others in size and colors.... ¼ oz. \$1.50	.25
2220	Unwin Dwarf Giant Flowered, Mixed. The flowers are semi-double on long, strong stems, and are borne in profusion on bushy plants.....	.25



Kelway's Show Delphiniums

No.		Pkt.
	D A T U R A (Trumpetflower). Handsome, hardy annuals of very rapid growth, with large, trumpet-shaped flowers. 3 ft.	
2240	Double Mixed. All sorts 1/4 oz.	35c \$0.15
	DELPHINIUM, Annual Varieties (Larkspur), Among the best of hardy annuals, lasting a long time in flower. The plants should be transplanted or thinned out to avoid over-crowding and to secure the branching habit.	
	TALL BRANCHING STOCK FLOWERED. 3 ft.	
2244	Appleblossom Pink 1/4 oz.	50c .15
2246	Brilliant Carmine 1/4 oz.	50c .15
2248	Dark Blue 1/4 oz.	50c .15
2250	Empress, Rose-pink 1/4 oz.	50c .15
2252	La France, Salmon-pink 1/4 oz.	50c .15
2254	Light Blue 1/4 oz.	50c .15
2256	Newport Scarlet 1/4 oz.	50c .15
2257	Rosamond, Pure rose, does not fade. 1/4 oz.	75c .20
2258	White 1/4 oz.	50c .15
2260	Mixed 1/4 oz.	50c .15
2262	Collection of 6 packets75
	GIANT IMPERIAL 4 ft.	
2263	Blue Bell, Clear light blue20
2264	Blue Spire, Deep blue 1/8 oz.	40c .20
2266	Lilac Spire 1/8 oz.	40c .20
2268	White Spire 1/8 oz.	40c .20
2270	Exquisite Soft Pink Imp. 1/8 oz.	40c .20
2272	Exquisite Rose 1/8 oz.	40c .20
2274	Gloria, Rich, deep rose. 1/8 oz.	40c .20
2276	Los Angeles, Rose on salmon ground. 1/8 oz.	40c .20
2278	Peach Blossom, Clear light pink. 1/8 oz.	40c .20

No.		Pkt.
2280	Mixed 1/8 oz.	40c \$0.20
2285	Collection of 6 packets	1.00
2300	Azure Fairy, Clear, light blue. 15 in.25
2301	Blue Gem, Deep blue. 9 to 12 in.15
2305	Blue Butterfly, Bright blue. 15 in. 1/4 oz.	\$1.00 .25
	DELPHINIUM, Hardy Perennial Varieties. From seed they are of easy culture and produce splendid spikes of bloom through the summer. When sown early they usually bloom in September. 1 to 5 ft.	
2310	Columbia Hybrids. An exceptionally fine strain selected from the best large flowering varieties, immense spikes. 1/4 oz.	\$1.50 .25
2312	Blackmore and Langdon's Prize Strain. A world famous strain . . . 1-16 oz.	\$1.50 .50
2315	Kelway's Show, Mixed. Saved from their celebrated collection of show varieties, which is undoubtedly the largest and finest collection of this popular perennial in existence 1-16 oz.	\$1.50 .50
2325	Belladonna Improved. Clear turquoise blue; the everblooming, hardy Larkspur; if sown early will bloom in late summer and autumn 1/8 oz.	\$1.25 .25
2326	Bellamosum, Deep blue 1/8 oz.	\$1.25 .25
2340	chinense (grandiflorum). Large, deep blue. 1 1/2 ft. 1/4 oz.	85c .10
2345	chinense album. Large white. 1/4 oz.	85c .10
2348	chinense, Cambridge Blue. Clear Belladonna blue. 2 to 3 ft.25
2365	formosum coelestinum. Light blue. 2 1/2 ft. 1/8 oz.	\$1.25 .25
2367	Hollyhock Delphinium, Wrexham Hybrids.50
2370	Hybrids, Wrexham, Pale Blue Shades. From newest large flowering sorts. 1/8 oz.	\$1.25 .25
2375	Hybrids, Wrexham, Dark Blue Shades. From new, large flowering sorts 1/8 oz.	\$1.25 .25
2380	King of Delphiniums. Deep blue, white center 1/8 oz.	\$1.25 .25
2382	Summer Cloud. Best perennial; pure white35
	DIANTHUS, or PINKS. Annual Varieties. These are really hardy biennials though treated as annuals, and bloom the first season from early summer until frost. They are beautiful border plants and deserve a place in every garden.	
	DOUBLE-FLOWERING VARIETIES	
2385	chinensis, Mixed. Indian Pink. 1/4 oz.	40c .10
2390	diadematus, Mixed, Diadem Pink. 1/4 oz.	\$1.00 .15
2395	heddewigi, Mixed, Japan Pink 1/4 oz.	60c .10
2400	laciniatus, Mixed, Lace Pink. 1/4 oz.	60c .10
2405	latifolius, Mixed. Large flowers, resembling the Sweet William in shades of rose, crimson and maroon. 1/4 oz.	75c .10
2410	nobilis, Mixed (Royal Pink). Largest size and brightest colors 1/4 oz.	50c .10
2415	Blood Red. Deep color; extra. 1/4 oz.	75c .10
2420	Mourning Pink. Deep crimson, white edge. 1/4 oz.	75c .10
2425	Salmon Pink (Salmon King). 1/4 oz.	\$1.00 .20
2430	White, Very fine variety. 1/4 oz.	75c .10
	SINGLE-FLOWERING VARIETIES	
2435	Crimson Belle. Dark red. 1/4 oz.	75c .10
2440	The Bride. White, purple eye 1/4 oz.	60c .10
2445	Vesuvius. Brilliant scarlet 1/4 oz.	50c .10
2450	Mixed. Finest colors and sorts. 1/4 oz.	50c .10
	DIANTHUS caryophyllus (Carnation Pink).	
2455	Riviera Market (Giant of Nice). Superior class of perpetual flowered Carnations.50

No.		Pkt.
2460	Marguerite, Giant Mixed. Improved and very large, double-flowered strain of this early flowering Carnation which blooms in four months from time of sowing 1/8 oz. 75c \$0.20	
2462	Giant Rose 1/8 oz. 75c .20	
2465	Giant Scarlet 1/8 oz. 75c .20	
2470	Giant Yellow 1/8 oz. 75c .20	
2475	Giant White 1/8 oz. 75c .20	
	Chabaud's Giant Improved French Carnation. Half hardy perennial. Seed sown early inside will bloom in six months. Clove-scented.	
2479	Cardinal Red (Sparkler)25	
2481	Crimson (Nero)25	
2483	Flesh Pink25	
2491	Rose Pink (The Pearl)25	
2492	Salmon Rose25	
2493	White (Jeanne Dionis)25	
2496	Yellow (Marie Chabaud)25	
2497	Finest Mixed25	
2500	DIANTHUS deltoides Brilliant. (Maiden Pink). Beautiful, hardy sort for rockeries, sunken gardens, etc. The flowers are bright pink, small and in abundance from May to Aug. 6 in. 1/4 oz. 85c .15	
2505	deltoides albus. White flowers .. 1/4 oz. 85c .15	
2508	DIANTHUS (Hardy Carnation) allwoodi. A new race of Hardy Pinks, very free flowering and producing about 75 per cent of double flowers. Mixed colors.... .50	
2520	scoticus fl. pl. Perfection. Prize strain of double Scotch or florists' Pinks in finest colors50	
2524	Sweet Wivelsfield. A hybrid of many colors. Seed started inside early will flower outside from early June to November. Seed planted outside in spring will flower the same season. Seed planted outside in July or August will flower early the following spring25	
2525	DIANTHUS plumarius (Hardy Garden or Clove Pink). Double mixed. Free blooming strain, with double or semi-double flowers of spicy odor; in finest colors 1/4 oz. \$1.00 .25	
2528	DIASCIA barbarae. 1 ft. coral-pink. Charming little rock garden annual.15	
2530	DICTAMNUS, Mixed (Fraxinella). Gas Plant. Very showy, hardy perennial... 1/4 oz. \$1.00 .15	
2532	DIDISCUS coeruleus (Blue Lace Flower). Hardy annual. 18 in..... 1/8 oz. 50c .15	
	DIGITALIS (Foxglove). Hardy perennials of easy culture, valuable for shrubbery borders, woodland walks, partially shady places. Blooms in June and July. 3 to 4 ft.	
2535	gloxinaeflora, Mixed. Fine colors, spotted in the throat 1/4 oz. 50c .15	
2540	grandiflora. Light yellow, fine.. 1/4 oz. 35c .10	
2545	Ivery's Spotted. An extra choice strain of beautifully spotted flowers.. 1/4 oz. 50c .10	
2548	Lutzii. Salmon hybrids. 4 ft. .. 1/8 oz. 50c .20	
2550	monstrosa, Mixed. Beautiful colors with one enormous flower at top of spike. 1/4 oz. 75c .15	
2553	The Shirley. Giant mixed..... 1/4 oz. 85c .20	
2555	purpurea, Mixed. All colors 1/4 oz. 40c .10	
2560	purpurea, Red 1/4 oz. 50c .15	
2565	purpurea, Rose 1/4 oz. 50c .15	
2570	purpurea, White 1/4 oz. 50c .15	

No.		Pkt.
2575	DIMORPHOTHECA aurantiaca (African Marguerite). Beautiful Transvaal annual, with a profusion of rich orange-gold flowers throughout the season. 15 in. 1/4 oz. 75c \$0.15	
2576	Eklonis. Pure white, blue center..... 1/8 oz. 60c .20	
2580	New Hybrids. Rich colors 1/4 oz. 75c .15	
2582	Salmon Beauty 1/8 oz. 60c .20	
	DOLICHOS (Hyacinth-bean). A beautiful, quick growing annual climber; the seed pods are quite ornamental. 10 ft.	
2585	Darkness. Rich, purple-violet Oz. 40c .10	
2590	Daylight. Snow white; excellent.. Oz. 40c .10	
2595	lablab, Mixed. Purple and white.. Oz. 30c .10	
2596	DORONICUM caucasicum. H. P. Early yellow, 2 ft.50	
2598	pardalianches (Bunch of Gold). H. P. 2 1/2 ft. Long-stemmed flowers of bright canary yellow, blooming in May and June.75	
	DRACAENA. Decorative plants, with long, graceful foliage; valuable for vases and house decoration; tender perennials.	
2605	indivisa. Narrow green foliage. 1/4 oz. 30c .10	
2610	Ornamental Foliage Sorts. Including the best and most brilliant colors..... .25	
2615	DRACOCEPHALUM moldavica. Fine hardy annual, with spikes of violet blue, Salvia-shaped flowers. 2 ft.10	
2620	ECHINACEA helianthus (Red Perennial Sunflower). Large, purplish red flowers freely produced through the whole summer. 5 ft.15	
2625	purpurea. Large purple, black disc. 3 ft... .15	
2630	ECHINOCYSTIS lobata (Wild Cucumber). Rapid growing annual climbers, with ornamental seed pods and large seed. Soak the seed in warm water over night and plant the eye down. 20 ft... Oz. 50c .10	



Dianthus deltoides

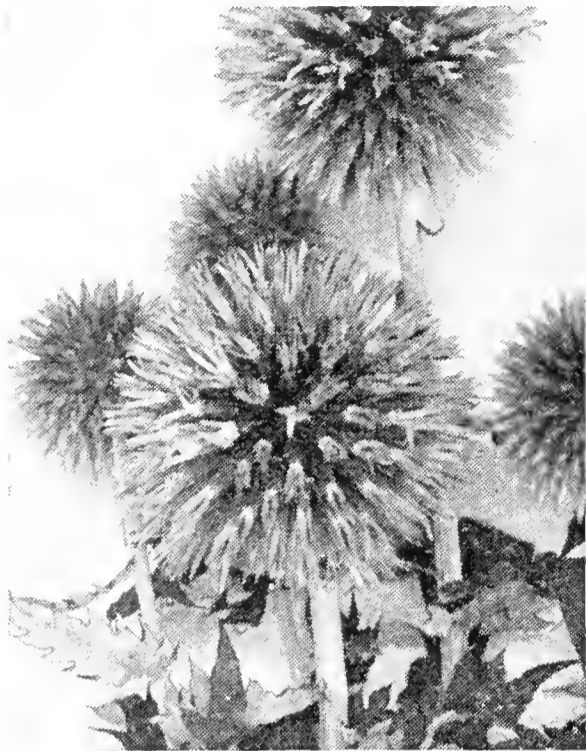

Echinops ritro



Erigeron



Eschscholtzia

No.		Pkt.	No.		Pkt.
2633	ECHINOPS ritro (Globe Thistle). Blue thistle-like flowers, silvery-white foliage	\$0.15	2708	Tango . Bronzy red overlaid terra cotta.. 1/4 oz. 50c	\$0.15
2634	ECHIUM (Blue Bedder). A new compact variety about 12 inches high with deep bright blue flowers25	2709	The Geisha . Fluted petals, orange-crimson	1/4 oz. 50c .15
2635	EDELWEISS (Gnaphalium leontopodium). Charming Swiss Alpine plant, with lovely star-shaped, white everlasting flowers25	2710	Finest Mixed . All colors	Oz. 50c .10
	ERIGERON (Midsummer Daisy). Effective hardy perennial, May to Oct. 1 1/2 ft.		2712	Ramona Strain Frilled Hybrids . A new, compact erect strain of fluted and frilled blossoms of many beautiful hues	Oz. \$1.00 15
2648	alpinus . Dwarf, free flowering with clusters of small purplish daisy-like flowers. Fine for rock gardens.25		EUPATORIUM . Free blooming, hardy perennials. Blooms first season from seed. Aug. to Oct.	
2650	aurantiacus hybridus . Shades of orange and yellow25	2715	ageratoides . Dense heads of small, white flowers. 4 ft.	1/4 oz. 75c .10
2655	speciosus hybridus grandiflorus . Large mauve color; excellent for cutting.....	.15	2720	fraseri . Snow white. 2 ft.....	1/8 oz. 1.00 .25
2660	ERYNGIUM amethystinum . A handsome, hardy perennial, with beautiful foliage and flowers of a lovely blue. Can be dried for winter. July, Aug. 3 ft.....	1/4 oz. \$1.00 .25	2725	EUPHORBIA heterophylla (Mexican Fire-plant). The beautiful orange-scarlet bracts completely cover the plant almost the entire season. Annual. 2 to 3 ft.	1/4 oz. 50c .15
2665	ERYSIMUM, Golden Gem . Golden yellow hardy biennial, like a miniature Wall-flower, effective for Spring bedding. 3/4 ft.	1/4 oz. 85c .10	2730	variegata (Snow-on-the-mountain). Foliage striped and margined with white. Annual. 1 1/2 to 2 ft.....	Oz. \$1.00 .10
	ESCHSCHOLTZIA (California Poppy). Profuse flowering plants, with bright, showy flowers; excellent for bedding massing or ribbon work. Hardy annual June to Oct. 1 ft.		2735	EXACUM affine . Dwarf, showy, tender annual for pot culture with clusters of fragrant lilac flowers. 1 ft.....	.25
2668	Double Autumn Glory . Frilled, outside orange-crimson, inside coppery orange.15	2738	affine atrocoeruleum . Fragrant and charming indoor plant producing numerous small dark lavender flowers with golden stamens. Foliage light green. Seedlings sown in Jan.-Feb. flower in June and continue until autumn50
2670	aurantiaca . Orange True California Poppy	Oz. 50c .10		FERNS . A well-known, graceful and attractive class of plants.	
2675	california alba	Oz. 50c .10	2740	Greenhouse Varieties, Finest Mixed25
2680	Carmine King . Deepest carmine..	Oz. 75c .10	2745	Hardy Varieties, Mixed . Finest sorts for outdoor growing25
2685	crocea fl. pl. Double orange.....	Oz. 75c .10	2750	Adiantum cuneatum (Maidenhair Fern)..	.25
2690	Frilled Pink . Delicate pink	Oz. 75c .10		FEVERFEW . See Matricaria .	
2691	Golden Glory . Double Golden - yellow deepening to orange at the center20		FORGET-ME-NOT . See Myosotis .	
2692	Golden West . Yellow, orange center....	Oz. 50c .10		FOUR O'CLOCK . See Mirabilis .	
2695	Mandarin . Inside orange, outside scarlet.	Oz. 75c .10		FOXGLOVE . See Digitalis .	
2705	Rose Cardinal . Creamy rose.....	Oz. 50c .10	2755	FRANCOA ramosa (Bridal Wreath). The long sprays of pure white flowers are largely used for table decoration. An excellent decorative greenhouse plant. 2 1/2 ft.25
			2760	FREESIA, New Hybrids Mixed . Beautiful variety, with new colors and delicate shades, blooming in six to eight months.	.25

No.		Pkt.
2765	FUCHSIA, Double and Single Mixed. The raising of Fuchsias from seed is interesting, there always being the possibility of securing something new and distinct; the seed offered is saved from a choice collection	\$0.50
	GAILLARDIA (Blanketflower). Beautifully showy annuals, giving a profusion of brilliant flowers during the summer and autumn. Fine for cutting. 2 ft.	
2770	Single, Finest Mixed. All colors..Oz. 75c	.10
2775	Double, Finest Mixed ¼ oz. 50c	.10
2780	Indian Chief. Single bronze red. ¼ oz. 50c	.15
	GAILLARDIA. Perennial varieties. 2 to 3 ft.	
2783	Burgundy. Shining wine red flowers, 2½ in. across. Plants bushy, 2½ ft....	.25
2785	sanguinea. Large, deep crimson with golden margin	¼ oz. 60c .15
2790	maxima. Large. pure yellow	¼ oz. 50 .15
2793	Portola hybrida (New). Bronzy red shades, golden tipped	½ oz. 50c .25
2796	Tangerine. Orange-red25
2797	The Dazzler. Red, tipped gold..	⅛ oz. 35c .15
2800	Finest Hybrids	¼ oz. 50c .15
2805	GAURA lindheimeri. Half hardy annual of graceful habit with numerous sprays of rosy white flowers throughout the summer. Fine for vases. 2 ft. ¼ oz. 50c	.15
2808	GAZANIA splendens hybrida grandiflora. 8 in. Half hardy perennial flowering first year. Plants spread close on the ground and produce brilliant orange, yellow and white daisy-like flowers marked with a black and silver zone at base of petals. Sunny location.35
2810	GENISTA canariensis (Broom). Handsome, half hardy perennials for room decoration, with bright yellow flowers. 2 ft...	.25
2815	andreana. Crimson and yellow, handsome	.25
2820	GENTIANA acaulis (Alpine Blue Gentian). Dwarf early, spring-flowering Alpine perennial, with intense blue, bell-shaped flowers, 6 in.	¼ oz. 85c .15
2825	lutea (Giant Gentian). Bright yellow flowers in whorls on stems. 4 ft high..	.15
	GERANIUM. Popular plants, easily raised from seed. Half hardy perennial.	
2830	Apple-scented. Fragrant foliage.....	.25
2835	Show Pelargoniums (Lady Washington). Newest large-flowered Show varieties.	.50
2840	zonale, Finest Mixed. Specially saved....	.15
2845	Double, Finest Mixed. Finest sorts.....	.50
2850	GERARDIA, New Hybrids. Spikes of handsome. Foxglove-like flowers; very free flowering perennials, blooming first season from seed and hardy in sheltered situations. July to September. 2 ft.....	⅓ oz. 25c .10
2855	GERBERA jamesoni (Transvaal Daisy). Beautiful Daisy of a brilliant orange-vermilion color, on long stems, blooming almost the whole year if given greenhouse protection during winter..	.50
2860	jamesoni Hybrids. New hybrids of the preceding which are more hardy and easily grown. The colors are rich and delicate, with a wonderful range from pure white through orange, salmon, rose, cerise, to ruby red and violet.....	.50

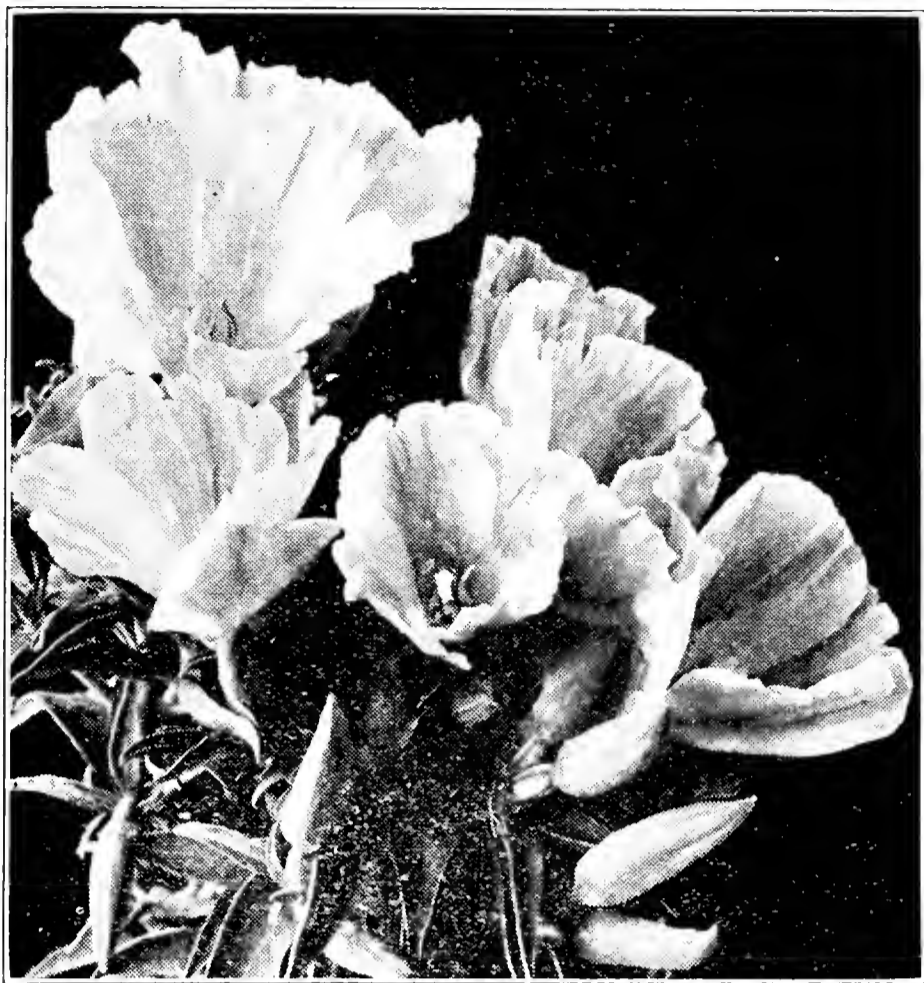

Godetia, (See page 20).

No.		Pkt.
2865	GESNERIA, Mixed Hybrids. Greenhouse bulbous plants with beautifully marked velvety foliage and handsome spikes of brilliantly colored flowers	\$0.50
	GEUM. Showy, hardy perennial of easy culture, and well adapted for the flower garden; fine for cutting. July to Oct. 2 ft.	
2875	coccineum. Bright scarlet	¼ oz. 30c .10
2876	Mrs. Bradshaw. Double scarlet.....	.25
2877	Lady Stratheden. Beautiful orange.....	.25
2880	GILIA, Finest Mixed. Showy, hardy annual, blooming from early in the season until frost. 1 ft.	¼ oz. 30c .10
2885	GLAUCUM flavum tricolor (Horned-poppy). Free flowering, hardy annuals. Handsome silvery foliage; orange-scarlet and black flowers in July. 2 ft. ..	¼ oz. 50c .15
	GLOBE-AMARANTH (Gomphrena). Showy annual everlasting; the flowers resemble clover heads, and when dried are used for winter decoration; fine for bedding. 1½ ft.	
2890	Purple	¼ oz. 25c .10
2895	Orange	¼ oz. 25c .10
2898	Rose	¼ oz. 25c .10
2900	White	¼ oz. 25c .10
2905	Mixed. All colors	¼ oz. 25c .10
	GLOXINIA. The seed offered has been selected from the finest erect flowering varieties and will give blooms of finest quality. For a succession of flowers from seed, sowings should be made at intervals from January to May. A moist heat of from 65 to 70 degrees is best to start them in.	
2910	Grey's Invincible Prize. Has the reputation of being the finest strain grown; very free flowering, with large open flower in the greatest variety of colors.	1.00
2915	Giant Mixed. A prize strain with large flowers of richest colors50

No.		Pkt.
	GODETIA (Satin Flower). Handsome hardy annuals, blooming profusely from July to October. Large, wide open flowers of shining satiny texture, and of the most delicate and brilliant colors. 1½ ft.	
2920	Duchess of Albany. Satiny white ¼ oz. 50c	\$0.10
2925	Double Rosy Morn. ¼ oz. 75c	.15
2930	gloriosa. Brilliant, blood red ¼ oz. 60c	.10
2935	Lady Satin Rose. Rich rose-pink. ¼ oz. 75c	.15
2937	Lavender. True color ¼ oz. 75c	.15
2938	Sweetheart. New Dwarf Double, Bright cream-pink ¼ oz. 75c	.15
2939	Sybil Sherwood. Bright salmon-pink.... ¼ oz. \$1.00	.25
2940	Mixed. Tall, double. Beautiful colors. ¼ oz. 35c	.10
	GOURDS, Ornamental. Quick growing vines desirable for covering arbors, walls, etc., and producing useful and ornamental fruit in great variety of shapes and colors. Tender annual. 15 to 20 ft.	
2945	Collection of 12 sorts 1.00	
2950	Angora. White spotted fruit Oz. 40c	.10
2955	Apple Shape. Striped fruit Oz. 40c	.10
2960	Bottle Shape. White and green. Oz. 40c	.10
2965	Dipper Shape Oz. 40c	.10
2970	Dishcloth or Sponge Oz. 40c	.10
2975	Egg Shape. Useful as nest eggs Oz. 40c	.10
2980	Gooseberry. Very small Oz. 60c	.10
2985	Hercules Club. 4 ft. long Oz. 40c	.10
2990	Orange Shape. Mock orange Oz. 40c	.10
2995	Pear Shape. Striped Oz. 40c	.10
2998	Pipe Gourd (Calabash) Oz. 40c	.10
3000	Serpent Shape. 4 to 5 ft. long.... Oz. 40c	.10
3005	Sugar Trough Oz. 40c	.10
3008	Turk's Turban. Small, bright red. Oz. 40c	.10
3010	Mixed Sorts. In great variety Oz. 30c	.10
	GRASS, Ornamental. See page 40.	
3015	GREVILLEA robusta (Silk-oak). Beautiful evergreen, with fern-like foliage, magnificent for decorative purposes, and well adapted for house culture. Tender perennial.... ¼ oz. 50c, oz. \$1.75	.15
	GYPSOPHILA (Babysbreath). Extremely light and graceful, hardy plants of easy growth, flowering from June to Sept. Useful for cutting to mix with other flowers.	
3020	elegans alba grandiflora. Large, white, annual ¼ oz. 15c, oz. 50c	.10
3022	elegans carminea. ¼ oz. 15c	.10
3025	elegans rosea. Rose-pink, annual. Oz. 50c	.10
3028	pacifica. Hardy perennial. New pink, blooming after the paniculata variety.	.20
3030	paniculata. Pure white, hardy... ¼ oz. 50c	.10
3035	fl. pl. Double, white, hardy. This variety produces about 60 per cent of double flowering plants.25
	HELENIUM. A most valuable hardy perennial, fine for cutting, as it gives an enormous crop of flowers in the late summer and autumn. 5 ft.	
3045	autumnale superbum. Golden; fine25
3050	bigelowi. Golden yellow, with black center15
3054	Riverton Gem. Old gold changing to wallflower red. 3 ft.25
3055	HELIANTHEMUM mutabile. Dwarf hardy perennial, with brilliant flowers of various colors; very profuse in bloom and suited for dry soil and rockeries. June to Sept. 6 in. ¼ oz. 60c	.15

No.		Pkt.
	HELIANTHUS (Sunflower). Well-known hardy annuals, the small flowering sorts being very useful for cutting, while the larger sorts are very ornamental and useful, blooming all summer.	
3060	Double Californian. Deep yellow. 5 ft. Oz. 50c	\$0.10
3065	Double Chrysanthemum flowered. Orange yellow, fine for cutting. 5 ft.... Oz. 60c	.10
3070	Dwarf. Orange. 3 ft. Oz. 50c	.10
3075	globosus fistulosus. Large, globe shaped, rich orange color. 7 ft. Oz. 30c	.10
3080	Single cucumerifolius (Miniature Sunflower). Small, bright yellow, with black center. 4 ft. Oz. 75c	.10
3090	cucumerifolius, Stella. Golden yellow. The largest miniature sort. 4 ft. .. Oz. \$1.00	.10
3095	giganteus uniflorus. One immense flower a foot or more across Oz. 35c	.10
4000	Giant Russian. Large. 6 ft. Oz. 20c	.10
4002	Golden Fleece. Small Cactus flowers, golden yellow; dark center15
4005	Maroon Prince. Deep crimson, shading lighter toward the points.... ¼ oz. 50c	.15
4010	Perennial Hybrids. The flowers vary in shades, size and form .. ¼ oz. \$1.00	.15
	HELICHRYSUM, Double Flowered. Pretty annual everlasting, blooming all summer; fine in mixed borders and useful as dried flowers for winter, for which purpose they should be gathered before fully open. 2 ft.	
4015	Mixed ¼ oz. 50c	.10
4016	Canary Yellow ¼ oz. 60c	.15
4017	Deep Crimson ¼ oz. 60c	.15
4018	Salmon ¼ oz. 60c	.15
4019	Golden Ball ¼ oz. 60c	.15
4020	Rose Queen ¼ oz. 60c	.15
4021	Silver Pink ¼ oz. 60c	.15
4022	Violet ¼ oz. 60c	.15
4023	White ¼ oz. 60c	.15
4024	HELIOPHILA leptophylla. 9 in. Excellent annual for border. Flowers ½ in across, bright blue with white eye.25



Helanium

No.		Pkt.
	HELIOTROPE. A universal favorite on account of its delicious fragrance; excellent for cutting. H. H. P.	
4025	Grey's Giant Dwarf. Splendid strain of low, compact growth 1/8 oz. 85c	\$0.25
4030	Giant Hybrids. Mammoth 1/8 oz. 85c	.25
4035	Mixed Dark Blue Shades 1/8 oz. 50c	.15
	HESPERIS matronalis (Sweet Rocket). Fragrant spring flowering hardy perennial, growing freely in ordinary soils.	
4045	Dwarf Pure White. Early. 1 ft., 1/4 oz. 50c	.15
4050	Pure White. 3 ft. Oz. \$1.50	.10
4055	Purple. 3 ft. Oz. 1.50	.10
4060	Mixed. Purple and white Oz. 1.00	.10
4064	HEUCHERA. Choice Hybrids. Dwarf hardy perennials. Spikes of numerous small bell-shaped flowers, well above the foliage. 1 ft.25
4065	sanguinea splendens. Brilliant crimson.	.25
	HIBISCUS. A showy class of plants suitable for mixed beds or borders, with large and beautifully colored flowers. Free flowering. Hardy perennials, unless noted.	
4070	Trionum. New. Large ivory flowers with maroon center, orange stamens. 2 ft. 1/4 oz. 35c	.10
4075	Crimson Eye. Large, pure white, crimson center, July to Sept. 4 ft. 1/4 oz 50c	.15
4078	Giant Red. 1/4 oz. 50c	.15
4080	moscheutos, Rose. Large, light rose. July to Oct. 4 ft. 1/4 oz. 50c, oz. \$1.50	.15
4085	moscheutos, White. Large, pure white. July to Oct. 4 ft. ... 1/4 oz. 50c, oz. \$1.50	.15
4087	moscheutos Hybrids. .. 1/4 oz. 50c, oz. \$1.50	.15

No.		Pkt.
	HOLLYHOCK. One of the oldest garden favorites and finest of our autumn flowers. Seed sown in February and potted on will bloom the same season, and July sown seed the next season. They require a well-drained, deep, rich soil. Hardy biennial.	
4095	Collection of 6 Double Varieties.	\$1.00
5000	Double Superb Mixed. An improved strain 1/4 oz. 75c, oz. \$2.75	.20
5002	Colorado Sunset. Copper to cream 1/4 oz. 75c, oz. \$2.75	.20
5005	Crimson 1/4 oz. 75c, oz. \$2.75	.20
5006	Exquisite. A large, double fringed Hollyhock in a variety of colors with margined and blotched petals	.25
5007	Imperator. Mixed. Flowers 5 or 6 in. across, fringed, with rosette centers...	.35
5007A	Lilac Beauty 1/4 oz. 75c, oz. \$2.75	.20
5007B	Maroon 1/4 oz. 75c, oz. \$2.75	.20
5008	Newport Pink 1/4 oz. 75c, oz. \$2.75	.20
5010	Orange Prince25
5012	Purple 1/4 oz. 75c, oz. \$2.75	.20
5015	Rose Pink 1/4 oz. 75c, oz. \$2.75	.20
5020	Royal Scarlet 1/4 oz. 75c, oz. \$2.75	.20
5025	Snow White 1/4 oz. 75c, oz. \$2.75	.20
5030	Yellow 1/4 oz. 75c, oz. \$2.75	.20
5035	Single Mixed 1/4 oz. 50c	.15
5036	Maroon 1/4 oz. 50c	.15
5038	Mauve 1/4 oz. 50c	.15
5039	Pink 1/4 oz. 50c	.15
5040	Rose 1/4 oz. 50c	.15
5041	Scarlet 1/4 oz. 50c	.15
5042	White 1/4 oz. 50c	.15
5043	Yellow 1/4 oz. 50c	.15
5044	Collection, 6 Single Varieties75

	EVERBLOOMING HYBRIDS (Annual). Beautiful flowers in all colors and shades, blooming the first season.	
5045	Double Mixed 1/4 oz. 75c	.15
5050	Single Mixed 1/4 oz. 60c	.15
5055	HONESTY, Mixed (Lunaria biennis). The seed pods, which are flat and broad, look like transparent silver and are much prized for winter decoration. 2 ft. 1/4 oz. 50c	.10
	HUMULUS (Hop). Rapid growing climbers, with handsome foliage. 15 to 20 ft.	
5060	japonicus. Green foliage, H. A. 1/4 oz. 30c	.10
5065	variegatus. Variegated foliage. 1/4 oz. 30c	.10
5070	lupulus. Hardy perennial 1/4 oz. 40c	.10
5075	HUNNEMANNIA fumaraefolia (Giant Yellow Tulip Poppy). Perennial. Flowers throughout the season. Blooms in three months from seed. 2 ft. ... 1/4 oz. 50c	.10
5078	Sunlite. Double perennial poppy with extra band of petals outside, giving the impression of an open flower at all times. Color, canary-yellow, foliage light gray-green. 2 ft.20
	IBERIS (Hardy Candytuft). Free flowering compact perennials, making a beautiful display early in the season; suitable for rockeries and borders. 1 ft.	
5080	gibraltarica. Very large flowers of a delicate lilac color 1/4 oz. \$1.50	.15
5083	Queen of Italy. Rosy lilac .. 1/4 oz. 50c	.15
5085	sempervirens. The evergreen Candytuft with glossy, deep green foliage and white flowers 1/4 oz. \$1.75	.15
	Annual Varieties. See Candytuft.	



Double Hollyhocks



Incarvillea

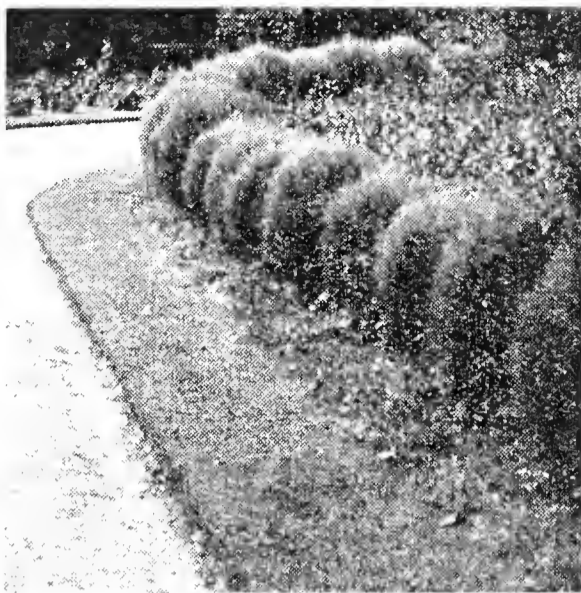

Kochia

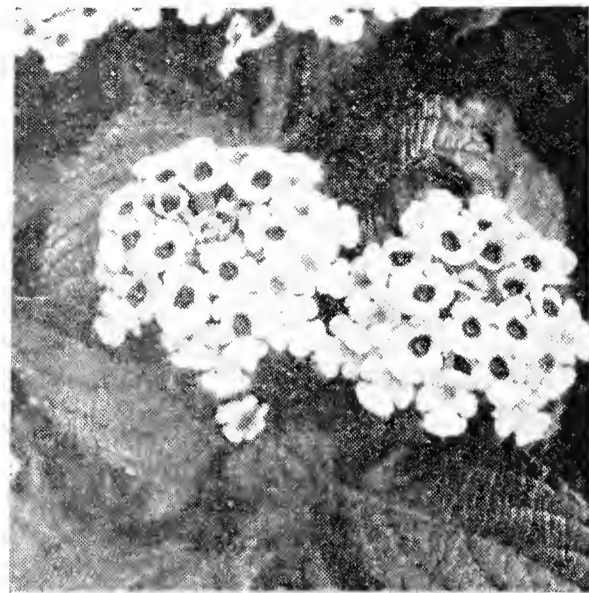

Lantana

No.		Pkt.	No.		Pkt.
5090	ICE PLANT. Half-hardy annual with leaves and stems thickly covered with sparkling ice-like globules. Fine for vases and piazza boxes, also for garnishing. Flowers white, 6 in. ¼ oz. 25c	\$0.10	5170	hybrida (Cardinal Climber). Large, brilliant cardinal-red flowers in clusters, all summer	\$0.25
	IMPATIENS (Sultan's or Zanzibar Balsam). A very fine, tender perennial for pot culture in the house or greenhouse and very useful for summer bedding, as they are in bloom continually.		5175	IRIS, Mixed Varieties. All sorts and colors of this beautiful spring and summer blooming hardy perennial	¼ oz. 75c .10
5095	holsti. Large, brilliant vermilion. 1½ ft.	.50	5178	KALANCHOE globulifera coccinea. Excellent winter flowering house plant. Brilliant scarlet Bouvardia-like flowers and small green foliage	.50
5100	holsti Hybrids. Choice colors of these large flowered new sorts. 1½ ft.	.35		JACOBS-LADDER. See Polemonium.	
5105	sultani. Large, rich bright rose. 1 ft.	.25		KENILWORTH IVY. See Linaria cymbalaria.	
5110	INCARVILLEA delavayi. Fine half hardy tuberous-rooted perennial, with large bright rose-colored, bell-shaped flowers in clusters. The tubers can be taken up and stored through the winter. 2½ ft.	.25	5180	KOCHIA trichophylla (Mock Cypress, or Belvedere). A pretty half-hardy annual forming compact bushes about 2½ ft. high, with small, feathery, light green foliage which changes to a crimson hue in September	¼ oz. 25c .10
5115	INULA glandulosa grandiflora. Very bold and handsome hardy perennial, large orange-yellow flowers. 2 ft.	.25	5182	KUDZU VINE. Easily grown from seed. Attains a length of 40-50 ft. from established roots. Flowers purple, pea-shaped, and borne in clusters late in the season. Foliage large and lobed	.15
	IPOMOEA. Splendid rapid growing climbers, with large, bright colored flowers; they are exceedingly pretty when grown among other climbers. Hardy annual. 15 ft.			LANTANA. Most elegant and showy bedding plants of as easy culture as Verbena or Geranium; flowers freely produced in beautiful clusters, and constantly changing in hue.	
5120	purpurea, Finest Mixed (Morning-glory, Convolvulus major)...Oz. 25c, ¼ lb. 75c	.10	5185	New Dwarf Bedding Hybrids. 1 ft.	.25
5125	purpurea, Double Mixed	Oz. 50c .10	5190	Tall Hybrids. 2 ft.	¼ oz. 50c .15
5130	coccinea (Star Ipomoea). Scarlet, star-shaped flowers in profusion	Oz. 60c .10		LARKSPUR. See Delphinium.	
5135	Heavenly Blue. Early flowering. Immense beautiful flowers of bright sky blue; seed should not be sown outside till ground is warm.	¼ oz. 75c .15		LATHYRUS latifolius (Perennial Pea). Handsome, free-flowering, hardy perennial climber of great beauty, with clusters of elegant, Sweet Pea-like flowers in great profusion; useful as a cut flower. 6 ft.	
5140	imperialis japonica (Japanese Giant). Most beautiful strain, with immense flowers of finest colors and markings	Oz. 60c .10	5195	albus. Pure white, very desirable,	¼ oz. 75c .15
5145	noctiflora hybrida (Moonflower). Large, fragrant, white flowers	Oz. \$1.00 .10	5200	Pink Beauty. Bright rosy pink.	¼ oz. 75c .15
5148	Rose Marie. New, double deep rose	.25	5205	splendens, Rich crimson	¼ oz. 75c .15
5150	setosa. Enormous leaves and large rose-colored flowers in clusters	Oz. 75c .10	5210	Mixed. All colors	¼ oz. 40c, oz. \$1.25 .10
	quamoclit (Cypress Vine). Finely cut fern-like foliage and masses of brilliant, star-shaped flowers.			LAVATERA (Bar Harbor Marsh Mallow). Large flowered variety, hardy annual, allied to the Mallows, covered during the entire summer with its pretty and showy blossoms. 3 ft.	
5155	Bright Scarlet	Oz. \$1.00 .10	5215	splendens. Rose	¼ oz. 50c .15
5160	Pure White	Oz. 1.00 .10	5218	splendens, Sunset. Rosy Carmine	¼ oz. 50c .15
5165	Mixed. Scarlet, white and pink.	Oz. 1.00 .10	5220	splendens. White	¼ oz. 50c .15
			5225	LAVANDULA vera (Sweet Lavender). Chiefly cultivated for the delicious and lasting fragrance of its flowers. Hardy perennial. July to September. 2 ft.	Oz. \$1.00 .15

No.		Pkt.	No.		Pkt.
5230	LEPTOSYNE maritima. Free flowering hardy annual, large single yellow Corceopsis-like flowers on long stems; fine for cut flowers. Aug. to Oct. 2 ft. ¼ oz. \$1.00	\$0.15	5280	hybrida, Sapphire. Deep sapphire blue, white eye. Fine for hanging baskets...	\$0.25
5232	Stillmani. A dwarf early flowering sort, fine for borders and for forcing in the greenhouse. 18 in.25	5285	speciosa (Crystal Palace). Spreading habit, with dark blue flowers ¼ oz.	85c .15
5234	LIATRIS pycnostachya. Purple, 4 ft. August to October. Hardy perennial.25	5290	White Lady. Compact, large flowered, pure white ¼ oz.	60c .10
5235	spicata. (Blazing Star). Desirable hardy perennial. The brilliant rosy purple flowers are on long spikes and freely produced. July to September. 2 ft.15	5295	ramosa (Erect growing). Rich blue, large flowered. 9 in. ⅛ oz.	50c .25
5240	LILIUM regale (Royal Lily).....	.50	5300	alba. Large white ⅛ oz.	50c .25
	LINARIA (Toadflax). Annual. 1 ft.		5305	Heavenly Blue. Large, clear blue ⅛ oz.	50c .25
5241	Fairy Bouquet. Dwarf. Compact, large, bright flowers in mixed colors.25	5310	rosea. Large, deep rose ⅛ oz.	50c .25
5243	maroccana, Excelsior Mixed15	5315	LOPHOSPERMUM scandens. Beautiful half hardy climber, suited for baskets and vases. Bright pink ⅛ oz.	60c .15
5243A	maroccana. Snow white.15		LUPINUS (Lupines). Old-fashioned and well-known annuals, very free growing, with long spikes of bright colored, pea-shaped flowers, and useful in a cut state. 2½ to 3 ft.	
5245	cymbalaria (Kenilworth Ivy). Beautiful, trailing plants for baskets or rock work15	5320	cruickshanki. Dark blue; fine....Oz.	50c .10
	LINUM. A valuable class of plants flowering for months and worthy of extended cultivation in masses or clumps in mixed borders. 1½ ft.		5325	hartwegi albus. White.....Oz.	\$1.00 .10
5250	grandiflorum rubrum. Brilliant scarlet, profuse flowering annual.Oz.	75c .10	5330	Cambridge Blue. Sky blue....Oz.	\$1.00 .10
5254	perenne, Blue. June-Aug. Fine for borders	.25	5335	Oxford Blue. Rich dark blue. .Oz.	\$1.00 .10
5255	Mixed Perennial Sorts. Fine .. ¼ oz.	50c .10	5340	roseus. Fine rose-pinkOz.	\$1.00 .10
	LOBELIA Most useful plants, free flowering and of easy culture. For bedding, edging, vases, etc. Treated as annuals, except the Cardinal varieties.		5342	luteus romulus. Large yellow, 1 ft. ¼ oz.	50c .20
5260	cardinalis. Brilliant scarlet; hardy. 3 ft.	.25	5345	mutabilis. White, sweet scented. Oz.	50c .10
5265	grandiflora. Flowers double the size of the old sorts; hardy. 3 ft.25	5350	roseus hybridus.Oz.	\$1.50 .10
5266	Blue Stone Erinus. Compact, clear blue without eye, best for bedding.25	5355	Mixed Annual Sorts. All colors. Oz.	50c .10
5267	Blue Wings. A splendid dwarf blue variety; large flowers25		LUPINUS (Lupines). Perennial Varieties. Handsome hardy perennials with immense spikes of pea shaped flowers. 3 ft.	
5268	Cambridge Blue. Light blue, large flowered, green foliage, compact25	5360	polyphyllus, Blue	Oz. 75c .10
5270	Crystal Palace compacta. Extra select dark blue; fine edgings. .. ½ oz.	\$1.00 .15	5362	Elliott's Sweet Scented. Mixed colors..	.20
5275	gracilis. Spreading habit, with bright blue flowers. ¼ oz.	75c .15	5363	Lavender Queen15
			5364	luteus. Yellow.20
			5365	moerheimi. Rose and white...Oz.	\$2.50 .25
			5370	roseus. Pink shades	Oz. \$1.50 .15
			5375	White	Oz. 75c .10
			5380	Mixed	Oz. 75c .10
			5385	Excelsior Mixed. New shades..Oz.	\$1.25 .15



Lobelia, Crystal Palace



Linum perenne



Lychnis chalconica

No.		Pkt.
	LYCHNIS. Hardy perennials with large terminal trusses of very showy flowers.	
5390	<i>chalcedonica.</i> Scarlet. 3 ft. ¼ oz. 50c	\$0.10
5395	<i>alba.</i> White. 3 ft. ¼ oz. 50c	.10
5400	<i>viscaria splendens.</i> Deep red. 16 in. ¼ oz. 60c	.10
5405	<i>haageana hybrida.</i> 18 in. ¼ oz. 85c	.15
5410	LYTHRUM roseum superbum. Vigorous perennial with spikes of bright rose colored flowers. 3 ft.15
	MALOPE. Free blooming, hardy annuals, with large, handsome, mallow-like flowers. July to Oct. 3 ft.	
5415	<i>grandiflora alba.</i> White.....Oz. 75c	.15
5420	<i>grandiflora rosea.</i> Rose-pinkOz. 75c	.15
	MALVA or MALLOW. Free flowering, hardy perennials. Sown early, will bloom first season.	
5430	<i>moschata</i> (Muskmallow). Clusters of fragrant rose-colored flowers .. ¼ oz. 50c	.15
5435	<i>alba.</i> White, fragrant. 2½ ft. .. ¼ oz. 50c	.15
	MARIGOLD, Double African. Handsome hardy annuals, with rich and showy flowers throughout the season. 3 ft.	
5436	All double Lemon. Tall large flowers.. ¼ oz. 40c	.10
5438	All double Orange. Tall large flowers.. ¼ oz. 40c	.10
5440	Dixie Sunshine. Brilliant golden yellow Chrysanthemum flowered type. Late blooming25
5445	Grey's Selected Orange Prince25
5450	Grey's Selected Lemon Queen25
	Above two sorts specially grown for us by a Scotch specialist and are without an equal.	
5451	El Dorado Mixture. Finest large-flowered sorts10
5452	Dwarf Double African Queen Mixed15
	MARIGOLD, French, Double. These are the small velvety flowered sorts. 1 ft.	
5485	Collection of 6 varieties, separate50
5486	Dark Brown10
5488	Dark Maroon. (Robert Beist) ¼ oz. 40c	.10
5490	Gold Striped.10
5491	Golden Ball10
5492	Harmony. Tubular deep orange centers flanked by broad velvety maroon-brown guard petals. Free blooming and early. ¼ oz. 50c, pkt.	.15
5494	Pallida. Sulphur-yellow10
5495	Pulchra. Spotted10
5500	Dwarf Double French Monarch Strain Mixed. Very compact, large tight double flowers in a wide color range.... ¼ oz. 40c, pkt.	.10
5504	Tall French, Double Royal Scot. 2-2½ ft. The large, well formed flowers are a striking combination of mahogany and gold stripes radiating from the center15
5505	Scotch Prize. Special Scotch strain, from double striped prize flowers only. 2½ ft. ¼ oz. \$2.50	.25
5510	Tall Double Mixed. 2½ ft. .. ¼ oz. 50c	.10
5512	Tall Single French Josephine. 3 ft. Brown with fine gold edge10
5514	Dwarf Single French, Fire Cross. Saffron-orange with brown-red center.15
5515	Legion of Honor (Little Brownie). Single golden yellow, with a large spot of crimson velvet. 1 ft.....¼ oz. 30c	.10



All Double Marigold

No.	MARIGOLD—Continued	Pkt.
5520	<i>signata pumila</i> (Tagetes). Single orange-yellow. 1 ft. ¼ oz. 50c	\$0.10
5522	Star of India. Single crimson striped yellow15
5524	MEXICAN DWARF ORANGE. Plants 15 to 18 inches, freely branched, bearing quantities of very large, semi-tubular-petaled flowers of bright orange.....	.15
5525	MATTHIOLA bicornis (Night-scented Stock). Delightfully fragrant towards evening. Hardy annual, with purplish red flowers. 1 ft. ¼ oz. 50c	.10
	MATRICARIA (Feverfew). Free flowering annuals, useful for groups, borders and pot culture; also fine for cut flowers.	
5528	<i>capensis alba plenissima.</i> 2 ft.. ¼ oz. 50c	.15
5530	Dwarf Double Snowball15
5535	Dwarf Double Golden Ball. Quilled petals. ¼ oz. 40c	.15
5540	MAURANDIA, Finest Mixed. Elegant twining plants, with purple, rose and white flowers. Splendid for hanging baskets, window boxes, etc. ½ oz. 75c	.10
5541	<i>barclayana.</i> Blue.25
5542	MECONOPSIS baileyi. Perennial sky blue. (Thibetan Poppy).50
	MESEMBRYANTHEMUM. Dwarf growing annuals of great beauty; excellent for rockeries, edgings, vases, etc. 6 in.	
5545	tricolor Mixed.15
5550	<i>cordifolium variegatum.</i> Handsome foliage and bright rose colored flowers. ..	.25
5552	<i>crinifolium</i> (Livingstone Daisy). Annual. Small flowers of various colors. 3-4 in. high. Ideal for carpeting and rockeries.25
	crystallinum. See Ice Plant.	
	MIGNONETTE (Reseda). The most popular and favorite annual for garden and house culture, producing quantities of deliciously fragrant spikes of flowers.	
5555	Improved Eclipse. The immense, fragrant spikes of flowers 10 to 15 in. long, are produced in the greatest profusion. A superior variety for winter blooming, exhibition or cutting 1/16 oz. \$2.00	.50
5560	Defiance. Very fragrant, large spikes, with individual florets of immense size..... ¼ oz. 40c, oz. \$1.25	.10

No.		Pkt.
5565	Giant Pyramidal. Large, fragrant spikes of reddish flowers. ... ¼ oz. 25c, oz. 75c	\$0.10
5570	Machet Improved. Dense spikes of very fragrant, dark red flowers; fine for pot culture ¼ oz. 50c, oz. \$1.50	.15
5575	Machet, Golden. Long, massive spikes with fragrant, golden-yellow flowers... ¼ oz. 25c, oz. 75c	.10
5580	Machet, White Pearl. Long spikes of fragrant white flowers ¼ oz. 50c.	.10
5590	odorata. The old-fashioned common sweet-scented sort Oz. 35c, ¼ lb. \$1.00	.10
5595	MIMOSA pudica (Sensitive plant). A tender annual of light and elegant growth, the leaflets of which fold up when touched; the pale, purplish flowers are produced at the axils of the leaves. 2 ft. ¼ oz. 50c	.15
MIMULUS. Showy, half-hardy annuals, with handsome flowers; excellent for pots or garden.		
5600	cardinalis grandiflorus. Large, bright scarlet. 2 ft.15
5605	tigrinus grandiflorus. Large - flowered, tigered and spotted varieties. 1½ ft....	.15
5610	Musk (Moschatus). Well known, popular plant, with fragrant, yellow flowers and foliage ½ oz. 85c	.25
5615	MINA lobata. A rapid growing annual climber bearing profusely racemes of orange-red flowers; prefer a warm situation.... ¼ oz. 85c	.15

MIRABILIS (Marvel of Peru, or Four-o'clock) Well known annuals, with most brilliant flowers of various colors, suitable for beds or borders. 2 ft.		
5620	Mixed. Brilliant colorsOz. 35c	.10
5625	Variegated Foliage, Mixed. All colors, with green and white leaves...Oz. 35c	.10

MOONFLOWER. See Ipomoea.

MORNING GLORY. See Ipomoea purpurea.

MOURNING BRIDE. See Scabiosa.

MOUNTAIN FRINGE. See Adlumia.

5640	MUSA ensete (Abyssinian Banana). A splendid, large-leaved, palm-like plant, suitable for open air in summer, and producing a striking effect; seedlings attain a very large size the first season; tender perennial...100 seeds \$2.50	.25
------	---	-----

MUSK PLANT. See Mimulus.

MYOSOTIS (Forget-me-not). These beautiful half-hardy perennials bloom the first season and succeed best in moist, shady situations. If sown in frames in July or August, fine plants may be had for spring blooming. Fine for edging or in beds with Pansies, Daisies, etc.

5645	Alpestris robusta grandiflora. Large, bright blue clusters. 1 ft. ... ¼ oz. \$1.00	.15
5650	Indigo or Royal Blue. Rich... ¼ oz. \$2.00	.25
5653	Indigo compacta. Very dwarf. ¼ oz. \$2.50	.25
5655	Victoria. Rich, bright blue, of dwarf, globular habit. ¼ oz. \$2.50	.20



Myosotis palustris

No.		Pkt.
5660	Victoria rosea. Fine pink ¼ oz. \$2.50	\$0.20
5670	dissitiflora Perfection. Bright blue flowers on long stalks last a long time, and are most suitable for table decoration at Christmas. Sow in June for winter blooming. The finest of all. 1 ft. ¼ oz. \$2.00	.25
5675	Palustris semperflorens (True Water Forget-me-not). Large, azure blue flowers. Blooms all summer ¼ oz. \$2.50	.25
5680	Ruth Fischer. Azure blue. The largest flowered variety ¼ oz. \$2.50	.25
5685	Stricta grandiflora. Upright, pillar-like habit; bright blue; very striking..... ¼ oz. \$1.50	.15
5690	Special Mixture. All colors... ¼ oz. \$1.00	.15

NASTURTIUM, Dwarf, or Tom Thumb varieties. Splendid for marginal lines to borders and indispensable summer bedding plants. They succeed best and flower better in poor soil and remain longer in bloom than perhaps any other annual. 1 ft.

Oz. 20c, ¼ lb. 50c, lb. \$2.00

5695	Collection of 12 colors	1.00
5700	Columbia Mixture. Our own mixture which we make up from separate and distinct sorts; is without an equal....	.10
5710	Bronze. Bronzy orange.....	.10
5720	Chameleon. Straw color, flaked and veined red10
5730	Crystal Palace Gem. Buff, spotted.....	.10

No.		Pkt.
NASTURTIUM—Continued.		
5735	Dark Crimson. Fine, deep color.	\$0.10
5740	Empress of India. Crimson, dark foliage	.10
5745	Golden King. Rich, golden yellow.....	.10
5750	King Theodore. Maroon, dark foliage....	.10
5755	King of Tom Thumb. Scarlet, dark foliage	.10
5760	Lady Bird. Yellow, barred with ruby....	.10
5765	Fearl. Pearly white.10
5775	Rose. Soft carmine-rose.....	.10
5795	Vesuvius. Salmon-pink, dark foliage....	.10
5800	Ivy-leaved, MixedOz. 25c, ¼ lb. 75c	.10
5805	Variegated-leaved, Mixed10
	Oz. 25c, ¼ oz. 75c	
DOUBLE NASTURTIUMS		
5808	Double Dwarf Gem Mixture. Compact form without runners. Excellent color range of good sized, sweet scented, double flowers	oz. 50c .15
5809	Double Dwarf Golden Globeoz. 50c	.15
5811	Double Gleam Hybrids. Collection of gorgeously colored, large, well-formed flowers thriving under almost any cultural conditions	Oz. 30c, pkt. .15
5812	Bodger's Sweet-Scented Golden Gleam. "A double variety from seed." Flowers rich golden yellow. Vines semi-trailing, about 2 ft. Fine for open garden or window boxes.....	Oz. 30c .15
5813	Double Orange Gleam. Deep glowing golden orange	Oz. 50c .15
5814	Double Scarlet Gleam. Immense blooms of fiery orange-scarlet, fragrant and double, on semi-dwarf plants..	Oz. 30c .15
5815	Double Salmon GleamOz. 50c	.15
5818	NASTURTIUM, Lilliput, Finest Mixed. A distinct and fine flowering class, with its small compact bushes and immense numbers of small blooms displayed well above the foliage.....	Oz. 35c .10
NASTURTIUM, Tall or Running Varieties.		
These are the large free flowering climbers for verandas, trellises and covering unsightly places. Seed pods picked when green and tender are used for pickling.		
Oz. 20c, ¼ lb. 50c, lb. \$2.00		
5822	Collection of 12 colors	1.00
5820	Columbia Mixture. Our own mixture, which we make up from separate and distinct sorts, is without an equal.....	.10
5825	Bright Rose10
5835	Coccineum. Bright scarlet.....	.10
5840	Dark Crimson10
5845	Dunnett's Orange. Orange-red10
5850	Edward Otto. Brownish lilac.....	.10
5858	Gold Garnet. Orange, spotted garnet....	.10
5865	King Theodore. Very deep maroon.....	.10
5880	Pearl. Almost white.....	.10
5892	Shillingi. Yellow spotted maroon.....	.10
5895	Sunlight. Giant, rich golden.....	.10
5900	Twilight. Rosy salmon.....	.10
5905	Vesuvius. Rich apricot, dark foliage....	.10
5910	Von Moltke. Dark rose10
5915	Ivy-leaved, Mixed. Ivy-like foliage and fringed flowers.....	Oz. 25c, ¼ lb. 75c .10
5920	Variegated-leaved, Mixed. An exceedingly fine acquisition ...	Oz. 25c, ¼ lb. 75c .10

No.		Pkt.
NASTURTIUM, lobbianum Varieties. These differ from the tall Nasturtiums in being more free flowering, richer and brighter in color, and with darker foliage, and are superior for house or conservatory, also vases, baskets, etc. Are a mass of color from early summer until frost.		
5925	Asa Gray. Almost white	Oz. 25c \$0.10
5930	Black Prince. Velvety black.....	Oz. 35c .10
5947	Firefly. Yellow, scarlet spotted...Oz. 25c	.10
5950	Golden Queen. Clear golden.....Oz. 25c	.10
5952	Lucifer. Glowing red, dark leaved.Oz. 25c	.10
5965	Napoleon III. Golden brown spot.Oz. 25c	.10
5970	Primrose. Cream brown spots....Oz. 25c	.10
5975	Regina. Beautiful salmon.....Oz. 25c	.10
5980	Rudolf Virchow. Ruby-rose	Oz. 25c .10
5985	Spitfire. Bright scarlet; splendid. Oz. 25c	.10
5990	Mixed. All colors.....Oz. 20c, ¼ lb. 60c	.10
5995	Madame Gunther Hybrids. Dark foliage hybrids	Oz. 25c .10
6000	NEMESIA strumosa suttoni, Improved Mixed. A valuable long-blooming annual25
6001	Blue Gem, strumosa nana compacta. 8 in.	.25
6002	Fire King, strumosa nana compacta. 8 in.	.25
6003	Orange Prince, strumosa nana compacta. 8 in.25
6003A	Rose, strumosa grandif. suttoni25
6004	White Gem, strumosa nana compacta. 8 in.25
NEMOPHILA. Splendid, showy hardy annual for beds or edgings; beautiful decorative plants in pots for spring flowering in house or conservatory. 1 ft.		
6005	insignis. Bright blue, white center	¼ oz. 20c .10
6010	Mixed. All shades	¼ oz. 20c .10

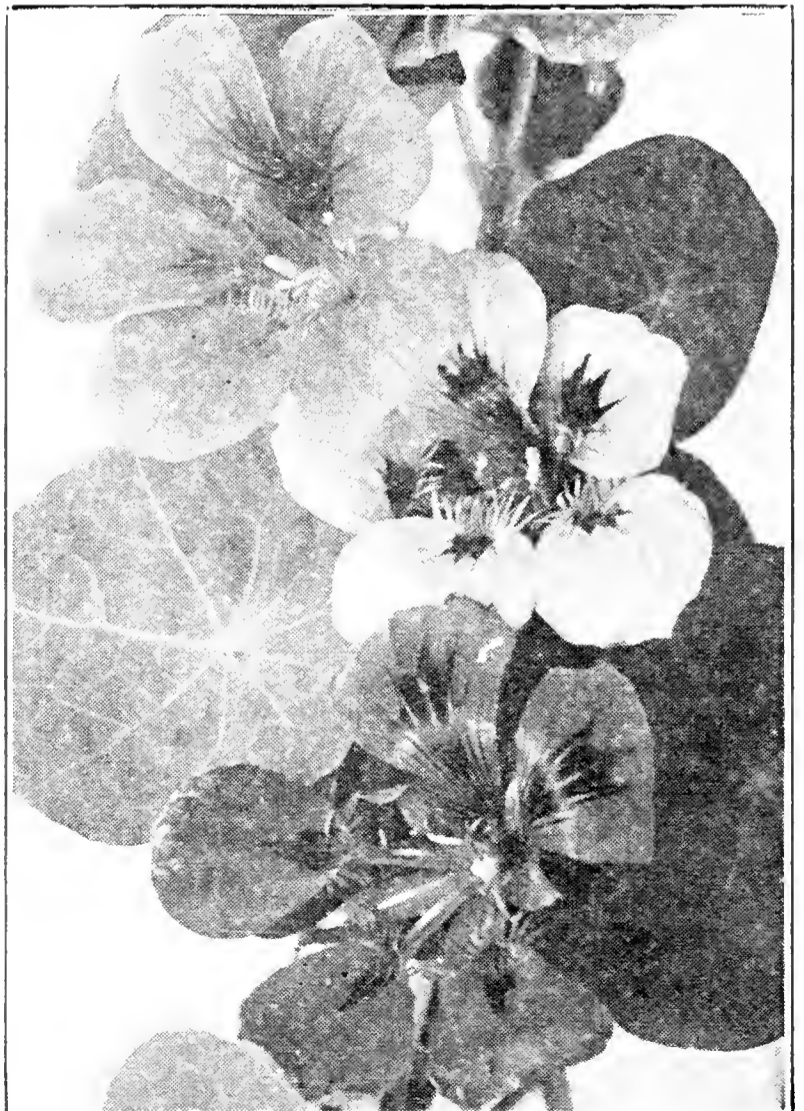

Columbia Mixture Nasturtiums



Nicotiana

No.		Pkt.
6065	fraseri. Large, deep yellow; fine ¼ oz. \$1.50	\$0.15
6068	fruticosa youngi. 1½ ft. Large golden yellow, reddish stems.25
6070	lamarkiana. 3 ft. Enormous yellow flow- ers from July to October.10
6072	missouriensis. 10 in. June to August. A low prostrate growing variety with ascending branches. Flowers very large soft yellow.25
6073	odorata. Yellow, fragrant ¼ oz.	40c .10
6075	speciosa rosea. Fine rose color ¼ oz.	75c .25
6090	OXALIS tropaeoloides. Fast growing, har- dy annual, with dark bronze foliage and deep yellow flowers, best suited to edgings, rockwork, vases, etc. 6 in. ¼ oz.	85c .15

PANSY. Too much importance cannot be attached to the culture of these beautiful plants. For early spring blooming the seed should be sown in July or August and the plants protected during winter. Early spring sown seed will give fine blooms during summer and fall. A good, cool, rich soil is essential. Rotted cow manure is the best fertilizer, and one cannot use too much. No fertilizer of a heating nature should be used; give plenty of water through dry weather. You cannot grow good Pansies under trees.

6095	Grey's Prize Exhibition Strain. This splendid mixture represents the highest perfection of large flowering, new high colored sorts; their brilliancy and richness are most striking. ⅛ oz. \$2.50, ¼ oz. \$4.00	.50
6100	Grey's Special Mixture. A grand mixture of the finest varieties, and one of the richest ever sent out; very striking and recommended for market growing ¼ oz. \$2.00, oz. \$7.00	.25

No.		Pkt.
	NICOTIANA. Very effective annuals; in bloom throughout the season, and produce their fragrant, tubular-shaped flowers in great profusion; excellent for cutting.	
6015	affinis. White; fragrant; 3 ft... ¼ oz.	35c \$0.10
6020	Choice Hybrids. A great variety of bright colors: fragrant ... ¼ oz.	60c .10
6022	Crimson Bedder. Dwarf, pyramidal rich deep crimson, 15 in.25
6025	colossea. Giant foliage plant of a dark glossy green, with reddish ribs. 5 to 6 ft.25
6028	hybrida, Pink Shades ¼ oz.	40c .10
6030	sanderæ. Brilliant carmine red. ¼ oz.	50c .10
6032	suaveolens. Small flowered species, pure white, delightfully scented. 1½ ft ..	.25
6035	sylvestris. Pure white. 4 ft.... ¼ oz.	50c .10
	NIEREMBERGIA. Graceful, half-hardy perennials of slender growth, blooming profusely the whole summer; fine for vases, baskets, etc.	
6040	frutescens. White and blue15
6045	gracilis. White and purple15
	NIGELLA (Love-in-a-mist). Interesting and free flowering, half-hardy annuals, with elegant cut foliage and curious flowers, of easy culture. 1½ ft.	
6050	Miss Jekyll. Beautiful long-stemmed variety, bright Cornflower blue.. ¼ oz.	35c .10
6052	Miss Jekyll. White ¼ oz.	50c .15
6055	Mixed. Shades of blue and white. Oz.	35c .10
6058	NOLANA atriplicifolia. 6 in. Lavender-blue rock garden annual, suitable for ground covers and edging.10
6060	NYCTERINIA capensis. 1 ft. Large heads of sweet-scented, white star-shaped flowers, produced throughout the whole season; hardy annual, ¼ oz.	50c .10
	OENOTHERA (Evening-primrose). A magnificent class of hardy plants, with large showy blossoms, preferring a light, sandy soil, and warm, sunny situations; July to October. 2 to 3 ft.	

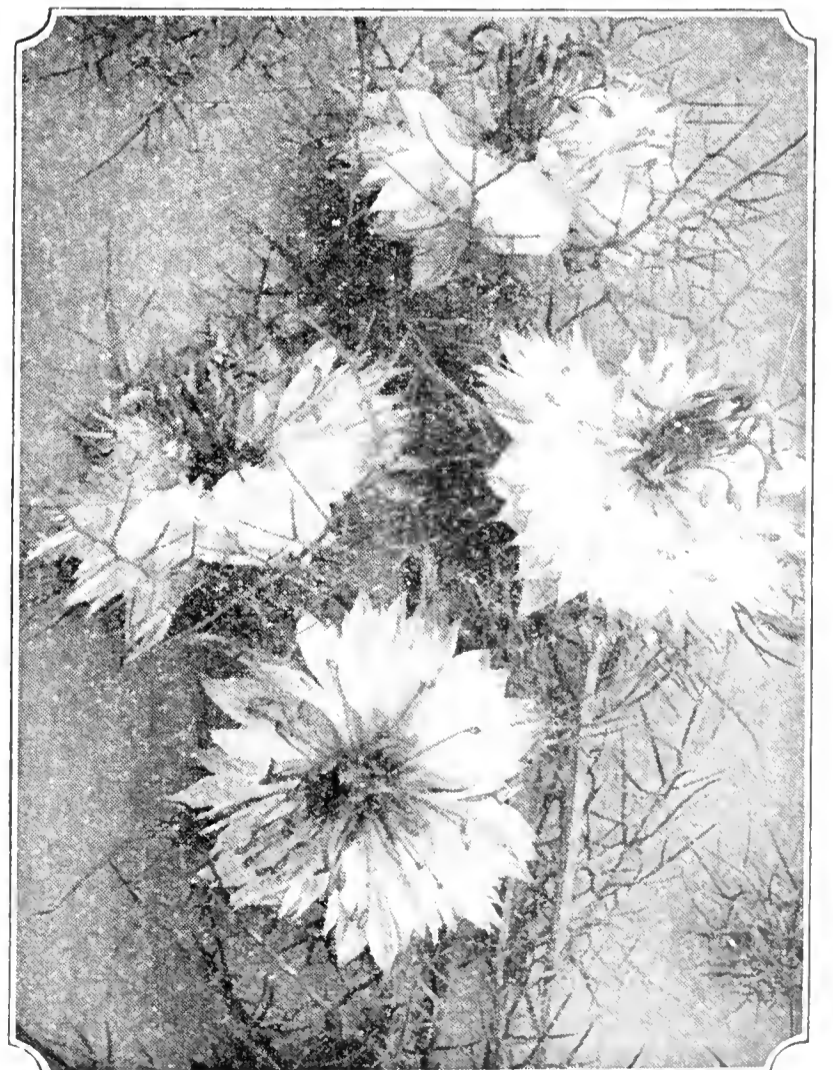

Nigella, Miss Jekyll

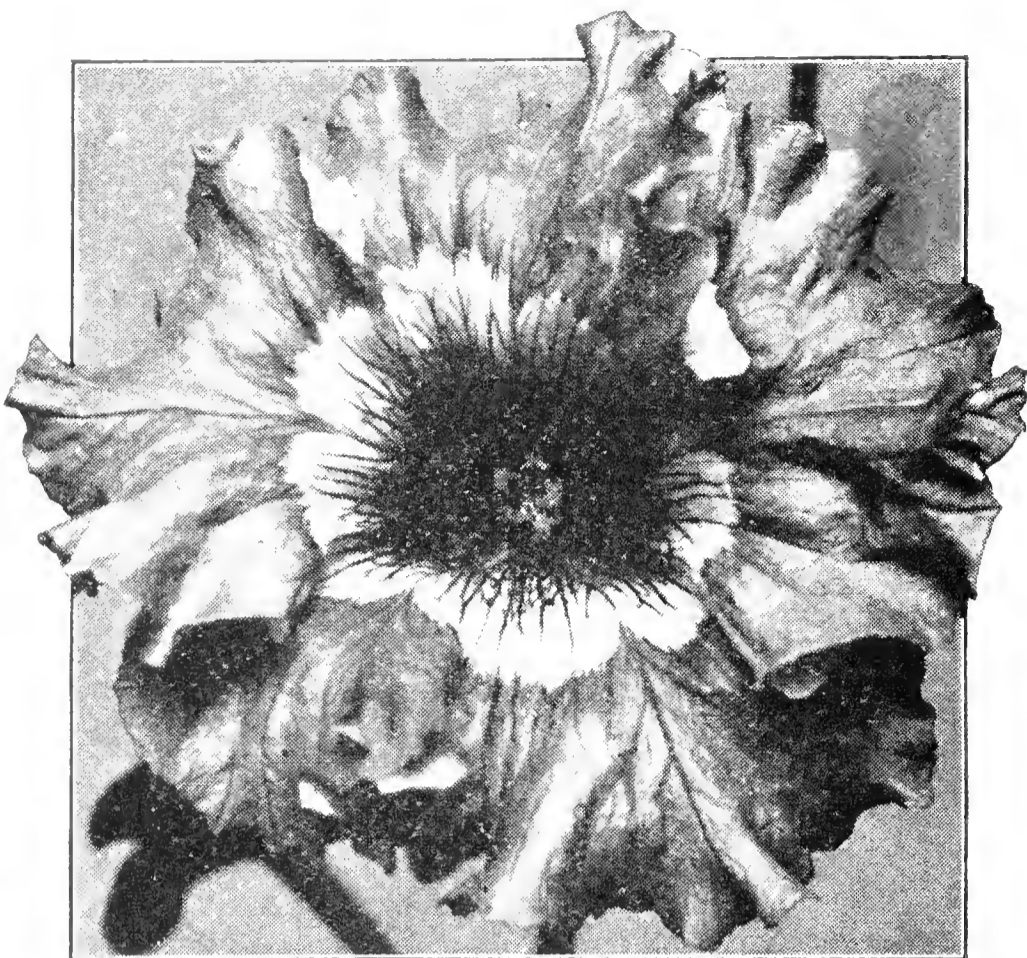

Superb Ruffled Giant Petunias

PANSY—Continued.

No.		Pkt.
6105	Bugnot's Superb Blotched. Very beautiful class of large flowers with broad blotches. Many of the upper petals are finely lined or veined; great diversity of the handsomest and rarest colors 1/4 oz. \$2.00	\$0.25
6110	Cassier's Giant Odier. A strain of great excellence, producing very large, rich and showy flowers 1/4 oz. \$2.00	.25
6115	colossea venosa. Giant, round flowers in light veined shades..... 1/8 oz. \$2.00	.50
6120	English Show. Selected compact strain of the finest large flowering sorts in splendid colors 1/4 oz. \$2.50	.25
6125	Giant Trimardeau. Very showy and vigorous size. 1/4 oz. \$1.50, oz. \$5.00	.15
6130	Maple Leaf Super Giants Mixed. New, compact habit with large, attractive foliage. Bright colored flowers averaging 4 inches across.....	.50
6135	Masterpiece. Frilled edge, giant flowers of the richest colors 1/4 oz. \$3.00	.25
6140	Matchless. English exhibition strain of immense size and substance in matchless variety of exquisite shades and art colors 1/8 oz. \$3.00	.50
PANSY, Giant, in Separate Colors.		
6155	Collection of 6 colors. Our selection....	1.20
6160	Adonis. Light blue; beautiful 1/4 oz. \$1.50	.25
6170	Bronze Shades 1/4 oz. \$1.50	.25
6175	Cornflower Blue 1/4 oz. \$1.50	.25
6180	Fire King. Crimson, yellow edge 1/4 oz. \$1.50	.25
6182	Gold Orange (St. Knud)25	
6185	Golden Queen. Pure yellow .. 1/4 oz. \$1.50	.25
6190	Golden Yellow. Dark eye.... 1/4 oz. \$1.50	.25
6195	Hortensia Red 1/4 oz. \$1.50	.25
6200	King of the Blacks. Velvety 1/4 oz. \$1.50	.25
6205	Lord Beaconsfield. Violet, top petals shading off to white .. 1/4 oz. \$1.50	.25
6210	Mme. Perret. Rose, ruby and crimson shades on white ground.... 1/4 oz. \$1.50	.25
6215	Peacock. Peacock blue, white edge 1/4 oz. \$1.50	.25

No.		Pkt.
6220	Psyche. Velvety violet, bordered with white; wavy petals 1/4 oz. \$1.50	\$0.25
6225	Ruby King. Extensive range of color from orange scarlet to pink 1/4 oz. \$1.50	.25
6230	Silver-edged. Purple, white edge 1/4 oz. \$1.50	.25
6235	Snow Queen. Pure white 1/4 oz. \$1.50	.25
6245	Violet. Fine violet-blue 1/4 oz. \$1.50	.25
6250	Vulcan. Brilliant, dark red, with five large black spots; frilled... 1/4 oz. \$2.50	.25
6255	White. Pure white, violet eye 1/4 oz. \$1.50	.25

TUFTED PANSIES. See *Viola cornuta*.

6260	PASSIFLORA caerulea (Passionflower). Fast growing and free flowering, ornamental perennial climbers, with large, showy blue flowers, suitable for conservatory or outside in summer 1/8 oz. 85c	.25
------	---	-----

PENTSTEMON. Valuable class of perennials, but are best treated as annuals. Seeds sown in February or March will make a fine display the same season. 2 to 3 ft.

6264	grandiflorum, Excelsior Mixed. Colors range from white to deepest scarlet... .25	
6265	Giant-flowering Hybrids. Superb strain saved from the finest large-flowered sorts; many new and rich colors 1-16 oz. \$1.00	.25

6275	digitalis. Pure white with violet spotted throat 1/4 oz. 75c	.10
6280	hartwegi albus. Large, pure white flowers	.25
6285	Southgate Gem. Glowing scarlet.25
6290	speciosus. Extra deep blue..... 1/8 oz. 50c	.10

6295	PERILLA atropurpurea laciniata. Dark bronzy purple fringed foliage; very ornamental hardy annual. 2 ft. 1/4 oz. 35c	.10
------	---	-----

PETUNIA. An exceedingly attractive and favorite hardy annual for both indoor and outdoor cultivation; when not in too rich soil they will flower profusely through the summer. 1 to 1 1/2 ft.

6296	Balcony Blue20	
6297	Balcony Crimson20	
6297A	Balcony Netted Blue Gem. Large steel blue flowers netted with deep violet....	.25
6298	Balcony Rose20	
6299	Balcony White20	
6300	Balcony Mixed20	

Dwarf Compacta Varieties.

6301	Celestial Rose. New Hybrid Nana Erecta. Deep rose; very compact..... 1/8 oz. \$1.00	.20
6302	Fringed Rose25	
6303	Heavenly Blue. 8 in. Light silvery blue. .25	
6304	Martha Washington. Frilled blooms about 3 inches in diameter. The frilled portion of the flower is a beautiful blush pink and the center portion is strongly veined a rich wine-red deepening in the throat to dark violet; the whole forming a striking contrast of colors25	

6306	New Miniature Rose Gem. The plant is neat and compact, five to six inches high and covered with rich rose colored blooms about two inches in diameter25	
------	--	--

6308	Striped. 8 in. 1/4 oz. \$1.25	.15
6310	Snowball. Pure white 1/4 oz. \$1.25	.15
6311	violacea nana compacta 1/4 oz. \$1.00	.15
6312	nana compacta Mixed15	
6313	Periwinkle, nana compacta. The delightful pastel blue flowers are large and borne in profusion and true to color, on plants of dwarf, compact growth.. .25	
6315	Howard's Star. Rich, dark crimson, with five-pointed white star .. 1/4 oz. \$1.00	.15

No.	PETUNIAS—Continued.	Pkt.
6317	Rose of Heaven. A very dwarf, brilliant rose-pink variety 1/8 oz. 75c	\$0.15
6325	Rosy Morn. Lovely, bright pink 1/4 oz. \$1.50	.15
6327	Violet Blue50
6330	White. Pure white, free bloomer. 1/4 oz. 60c	.10
6335	Striped and Blotched. 1/4 oz. 50c, oz. \$1.50	.10
6340	Splendid Mixed. Rich colors, superb strain 1/4 oz. 60c, oz. \$2.00	.10
Grandiflora or Large-flowering Sorts		
6345	Elk's Pride. Large, dark velvety purple, plain edge25
6348	Fimbriata caerulea. Fringed steel blue Petunia, deeper blue throat heavily veined; a very fine light blue sort50
6350	Fringed Perfection. Immense, deeply fringed flowers; exquisite colors25
6352	Fringed Violet Hybrid. Rich velvety violet.35
6355	Superb California Giants. The flowers of this reselected strain are deep throated and very large, of great excellence and variety of colors25
6360	Superb Ruffled Giants. A California strain of extraordinary size and colors with deeply ruffled or fluted edges	.50
6362	New Dwarf California Giants. A very compact type of the Giant Petunia. Very large, well formed flowers. Specially recommended for pot culture. Throats well marked and veined.75
6364	Theodosia. Fringed, soft rose-pink, large.	.35
6365	White Beauty. Immense ruffled and fringed snow white flowers25
6367	White Cloud. Compact bushes covered with pure white blooms. 12 in.35
Double Large-flowering Sorts. Seed saved from the most carefully hybridized flowers. The weaker seedlings should be carefully saved, as these invariably produce the finest double flowers.		
6370	Fringed, Grey's Select. One of the finest strains in existence. The double flowers are very large, full and beautifully formed50
6370A	Giant Double Fringed Crimson. Very large; new	1.00
6371	Giant Double Fringed Heliotrope. Very large; new	1.00
6372	Giant Double Fringed Rose-Pink and White. Bright rose-pink with a large white frill giving the flowers the appearance of huge balls of pink and white lace. 5-6 in. in diameter.....	.50
6373	Double Rose Queen. Immense fringed flowers 5-6 in. in diameter, coming quite true from seed and very double.	.50
6374	Double White Madonna Giant. Double fringed, deeply fluted flowers.....	.50
6375	grandiflora, Mixed. Choice strain25
6376	Rosy Morn. Double; same color and habit as single Rosy Morn.35
6380	PHACELIA campanularia. Beautiful annual with rich, deep blue, bell-shaped flowers; blooms in about eight weeks from seed. 3/4 ft..... 1/8 oz. 35c	.10
PHLOX drummondii. These beautiful, hardy annuals continue in bloom the whole of the summer, and for bedding or massing nothing can surpass them for brilliancy and richness of color or profusion of flowers. 1 to 1 1/2 ft.		
6385	grandiflora collection of 6 colors, separate	.50
6390	Finest Mixed. An improved strain, with very large flowers and trusses; in brilliant colors 1/4 oz. 85c	.10
6395	Brilliant Scarlet 1/4 oz. 85c	.10
6400	Crimson. White star center 1/4 oz. 85c	.10
6410	Rose Pink. Fine shade. 1/4 oz. 85c	.10
6415	Pure White 1/4 oz. 85c	.10

No.		Pkt.
6417	Salmon Pink 1/4 oz. 85c	.10
6418	Violet. White eye 1/4 oz. 85c	.10
6420	Yellow 1/4 oz. 85c	.10
6425	cuspidata, Finest Mixed. Beautiful star-shaped flowers in showy colors 1/4 oz. 75c	.10
6428	Gigantea Art Shades. A new strain of Phlox Drummondii with flowers an inch and a quarter in diameter. It has a most wonderful range of color in soft Art Shades. The soft colors blended together make a most beautiful mixture. Plants about 9 inches high. Winner of Award of Merit in the 1935 All-America Selections..... 1/8 oz. \$1.00	.25
6430	Dwarf, Extra Mixed. An excellent, compact strain for pot culture or edgings. blooming early throughout the season. Finest colors. 6 in..... 1/8 oz. \$1.00	.25
6433	Apricot 1/8 oz. \$1.25	.25
6435	Bright Scarlet 1/8 oz. \$1.25	.25
6438	coerulea stellata. Mauve, white eye, 1/8 oz. \$1.25	.25
6440	Daybreak Pink 1/8 oz. \$1.25	.25
6445	Pure White 1/8 oz. \$1.25	.25
6446	Yellow 1/8 oz. \$1.25	.25
6450	Collection. 6 dwarf varieties, \$1.25.	
6465	PHYSALIS francheti (Japanese Winter-cherry). Hardy perennial, treated as an annual, fruiting first season from seed. A Japanese variety of the Ground-cherry, with edible fruit in large brilliant red capsules, which retain their color for months; fine for winter decoration. 2 ft. 1/4 oz. 75c	.15
6470	PHYSOSTEGIA virginica (Texas Heath). Fine hardy perennial, resembling a giant heather with beautiful pink flowers through the summer. Fine for cutting. 2 ft. 1/4 oz. \$1.00	.15
6475	virginica alba. Large white. .. 1/4 oz. \$1.00	.25
PINKS. See <i>Dianthus</i> .		
6480	PLATYCODON grandiflorum. Handsome hardy perennial, with large, deep blue, bell-shaped flowers, from June to Oct; allied to the Campanula. 2 ft. 1/4 oz. \$1.00	.15
6485	grandiflora alba. Large white. 1/4 oz. \$1.00	.15
6490	mariesi. Dwarf, compact sort with rich blue flowers. 1 ft. 1/4 oz. \$1.50	.25



Annual Phlox.

No.		Pkt.
6495	POLEMONIUM caeruleum , blue (Jacobs-ladder). Hardy perennials with large heads of showy flowers. May to August. 2 ft. ¼ oz. \$1.00	\$0.15
	POPPIES, Single Annual Varieties. For hardiness and easy culture these showy plants cannot be surpassed. They are very free flowering and make a gorgeous display.	
6500	Admiral. Large, single, white, with a broad edge of bright scarlet. Oz. \$1.25	.10
6502	American Legion. Brilliant scarlet with white maltese cross. Oz. 75c	.10
6505	Danebrog. Single scarlet, with white blotch on each petal oz. 75c	.10
6510	English Scarlet. The common scarlet field Poppy oz. \$1.25	.15
6515	glaucum (Tulip Poppy). Vivid scarlet. 1 ft. ¼ oz. 25c	.10
6518	Picotee. White edged scarlet.. ¼ oz. 25c	.10
6520	Shirley, Extra Selected. A much improved strain, with flowers of large size and from the most distinct and charming colors. The flowers are of a shining silky texture. 2 ft. .. ¼ oz. 25c, oz. 75c	.10
6523	Apricot. A beautiful shade .. ⅛ oz. 40c	.15
6524	Blue Shades ⅛ oz. 35c	.15
6525	Salmon Shades ¼ oz. 60c	.15
6530	The Bride. Large, pure white, 2 ft. Oz. 75c	.10
6535	umbrosum. Rich vermilion, with black spot at base of each petal. 1½ ft. Oz. \$1.00	.10
6540	Collection of 6 Single Varieties50	
	POPPIES, Double Annual Varieties.	
6545	American Flag. Large, snow white, fringed flowers, bordered with scarlet. 2 ft. Oz. \$1.00	.10
6550	Cardinal Hybrids. Semi-dwarf, beautiful class, with large flowers in richest and brightest colors. 1½ ft. ¼ oz. 30c	.10
6555	Carnation-flowered mixed. Large, showy fringed flowers in choice colors. Oz. 75c	.10
6560	Japanese Pompon, Mixed. Beautiful, small double flowers. 1 ft. ¼ oz. 50c	.15
6565	Mikado. Double white fringed petals, tipped with crimson. 2 ft. Oz. 75c	.10

No.		Pkt.
6570	Peony-flowered Mixed. Immense globular flowers; in choice colors. 2 ft. .. Oz. 75c	\$0.10
6575	Pink. Immense bright pink.... Oz. 85c	.10
6580	Scarlet. Immense flowers..... Oz. 85c	.10
6585	White. Immense, pure white.... Oz. 85c	.10
6590	Yellow. Immense, clear yellow.. Oz. 85c	.10
6592	Cavalcade. New double Begonia-flowered. Orange-scarlet. ⅛ oz. 40c	.15
6595	Sweet Briar. New double Begonia-flowered Shirley Poppy. Deep rose-pink15	
6596	salmonium. Double Shirley in all salmon shades15	
6605	Collection of 6 Double Varieties50	
	POPPIES, Hardy Perennial Varieties.	
6610	Alpine, Mixed. Pretty dwarf, free flowering sorts, in delicate colors. ½ ft. .25	
6615	Iceland Poppies, nudicaule. Sunbeam Single Mixed. Beautiful border plant with bright, delicate colors, and if sown early will bloom the first year. 1 ft. ¼ oz. \$1.25	.20
6620	Bright Yellow ¼ oz. \$1.25	.25
6622	Iceland, Coonara Pinks. Mixed hybrids in various shades of pink and yellow. Introduced from Australia; will bloom the same season from early spring sown seed. Strong stems and large flowers25	
6624	Iceland, El Monte. Very large, deep tangerine flowers borne on long, wiry stems. Comes true to color. Blooms in six months from seed. Fine as a cut flower.25	
6625	Orange Scarlet ¼ oz. \$1.25	.25
6630	Pure White ¼ oz. \$1.25	.25
6635	Double Mixed. All colors ... ¼ oz. \$1.50	.25
6637	The Emperor. Extremely large fluted-petaled flowers of deep orange25	
6638	The Empress. Giant flowered with broad fluted petals. Lovely shades of salmon, rose and pink25	
6639	Gartref Strain Mixed. Pastel colors, picotee markings25	
6640	Orientele. Very large, brilliant scarlet with black blotch. 3 ft. .. ¼ oz. 70c	.10
6650	Livermore. Deep crimson... ⅛ oz. 75c	.25
6652	Mrs. Perry. Orange-apricot25	
6654	Pink Beauty. Light pink. ... ⅛ oz. \$1.00	.25
6655	Queen Alexandra. Bright rosy salmon	.15
6660	Royal Scarlet. Immense blooms.....	.15
6665	Salmon Queen. Salmon-yellow. ⅛ oz. 50c	.15
6670	White. New large white25	
6675	Hybrids. Choice shades.... ¼ oz. \$1.00	.15
	PORTULACA. One of our finest hardy annuals, specially adapted to light soils, dry, sunny situations and exposed rockeries. Flowers freely during the hottest weather. 6 in.	
6680	Double-flowered, Mixed. Perfectly double flowers in brilliant and striking colors ¼ oz. \$1.25	.25
6685	Single-flowered, Mixed. Large flowers in most brilliant colors ¼ oz. 60c, oz. \$2.00	.10
6690	Rose ¼ oz. 60c, oz. \$2.00	.10
6695	Scarlet ¼ oz. 60c, oz. \$2.00	.10
6700	White ¼ oz. 60c, oz. \$2.00	.10
6705	Yellow ¼ oz. 60c, oz. \$2.00	.10
6710	Collection of 4 colors, separate35	
	POTENTILLA. A showy class of hardy perennials, producing in great abundance rich colored flowers of velvety texture; July to October. 1½ to 2 ft.	
6715	Double Hybrids, Mixed25	
6720	Single Hybrids, Mixed ¼ oz. 60c	.15

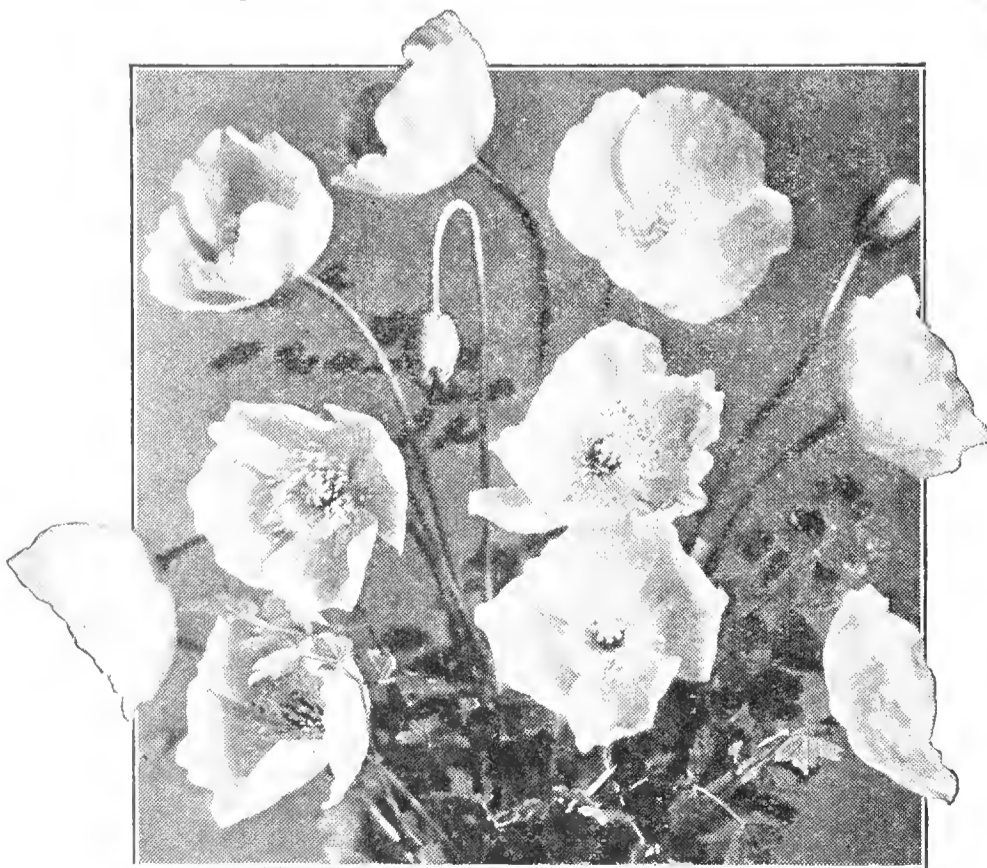

Iceland Poppies

No.		Pkt.
	PRIMULA or PRIMROSE. Hardy and half-hardy sorts. The following Primulas are exceedingly charming and useful plants for growing under glass or in the open air. Most of the hardy sorts require, in our climate, protection during winter.	
6725	auricula. Saved from a large and varied collection of choice colors	\$0.25
6730	Garden Primrose, New Hybrids (Acaulis). An excellent, large flowering strain of bright colors	1/8 oz. \$3.00 .25
6735	Blue. Clear blue color25
6740	Yellow. English Primrose ..	1/8 oz. \$1.50 .25
6745	polyanthus, Giant Mixed. New large flowering strain of the brightest colors25
6750	Finest Fancy Mixed. Extra choice strain15
6755	fold Laced. Yellow edged sorts15
6759	Large-flowered Bedding Hybrids. Dwarf upright25
	PRIMULA chinensis (Chinese Primrose). All chinensis and stellata Primroses are grown for us by an English specialist who grows nothing but Primulas. For excellence in every point they cannot be equalled.	
6760	Grey's Giant Mixture. A mixture of giant Primroses	1.00
6765	Half packet of Giant Mixture50
6770	Grey's Giant White. The largest and best white ever sent out; flowers of great substance	1.00
6775	Grey's Giant Pink. The finest and largest flesh pink; petals extremely large and of great substance	1.00
6780	Grey's Giant Crimson. Most lovely rich velvety crimson, fine habit, good substance and very free flowering	1.00
6785	Grey's Giant Salmon. A distinct and valuable sort with massive trusses of salmon-pink flowers well above the foliage	1.00
6790	Grey's Giant True Blue. Beautiful fringed blossoms of immense size, fine substance and freely produced; the best blue	1.00
6795	Grey's Orange King. A grand new sort, said to be an entirely new color in Primulas, a beautiful orange color in bud and when open of a terra cotta shade with orange-salmon around the edge; very large and free	1.00



Primula chinensis

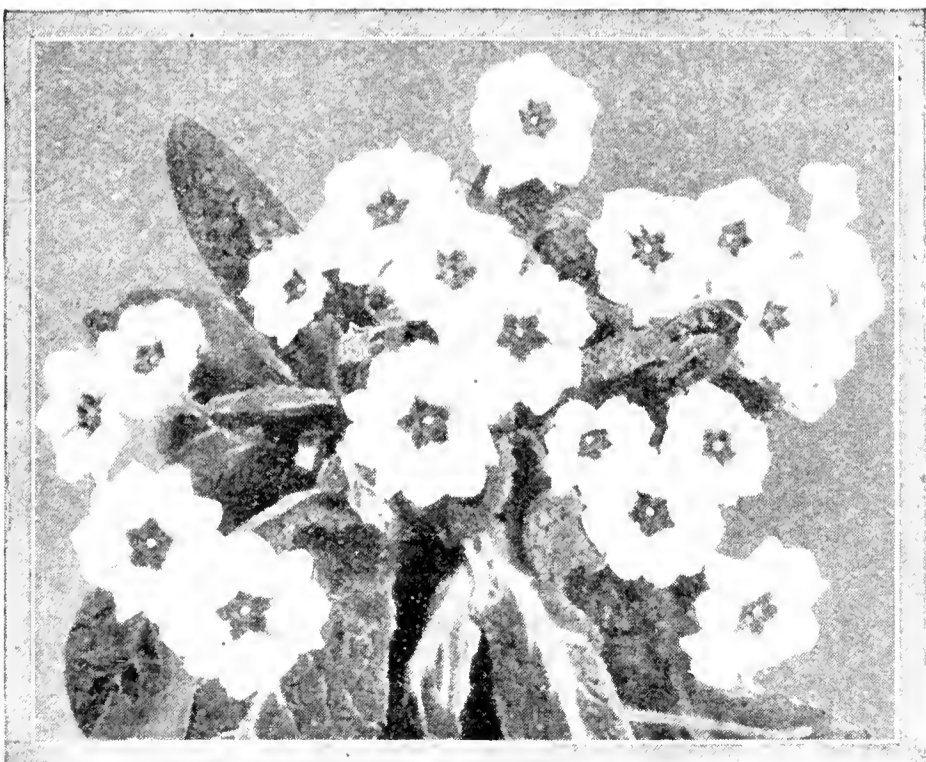

Primula vulgaris, English Primrose

No.		Pkt.
6800	Giant Art Shade. One of the most lovely yet introduced. The immense blooms are fringed and curved; the color is an art shade of an intense fiery glare	\$1.00
6810	Giant Chiswick Red. Improved strain, with large, beautifully fringed crimson-scarlet flowers75
6820	Dazzler. New. The most vivid of all flowers. The flowers are brilliant orange-red, produced well above the attractive foliage. About 20 blooms open at one time.....	1.00
6835	Giant King George V (New). The darkest crimson yet offered, of giant size, beautifully fringed, very free flowering and of massive substance75
6840	Giant Queen Mary (New). One of the finest ever raised, erect, free flowering, of great substance, and of a lovely delicate flesh pink color75
6845	Giant Ruby Queen. One of the finest of all the deep red sorts; the flowers are large, finely fringed, and of an intense rich scarlet with bright yellow eye75
6850	Giant Duchess. Most distinct and beautiful, having large pure white flowers with a zone of carmine-crimson around a clear yellow eye.75
	PRIMULA stellata, or Star Primrose. This valuable and very distinct variety should be extensively grown for greenhouse and table decoration. The innumerable star-shaped flowers make an effective contrast to the attractive dark foliage.	
6855	Blue Star Improved. A strain of very large dark blue flowers and pale green foliage75
6860	Brilliant Rose Star. Bright rose flowers and graceful, dark green fern leaf foliage, which is red underneath75
6865	Crimson Star. Fine colored sort with large, brilliant, rich crimson flowers75
6870	King of Star. Deep crimson75
6875	Salmon Pink Star. Improved strain75
6880	White Star. Improved large, pure white75
6885	Mixed Star. A special mixture75

7045 **ROMNEYA coulteri** (Giant White California Poppy). Pkt.
 A California perennial, with immense, pure white, fragrant flowers, with golden center, blooming continually from June to September; makes a fine pot plant and requires protection in winter. The seed will sometimes remain dormant for months after planting. 3 ft.\$0.15

RUDBECKIA (Coneflower). Beautiful border plants lasting a long time in bloom and excellent for summer and autumn display; each bloom is like a miniature sunflower. 2 ft.

7050 **bicolor superba**. Orange-yellow with velvety brown center; annual ¼ oz. 50c .15

7052 **Kelvedon Star**. Annual. Deep golden yellow with mahogany zone; long-stemmed. Single and semi-double25

7054 **My Joy**. Bright orange flowers sometimes 5 inches across, with small centers. Excellent for cutting and borders20

7055 **newmanni**. Golden yellow with velvety maroon center; hardy perennial15
purpurea. See Echinacea.



Salpiglossis

7060 **SAINTPAULIA ionantha grandiflora**. Pkt.
 Charming greenhouse plant, with beautiful deep blue flowers, 1¼ inches in diameter, resembling the violet\$0.25

SALPIGLOSSIS, Improved Large-Flowering. Very beautiful free flowering annuals in great variety of color. The large, richly colored flowers are elegantly veined, and penciled, blooming from July to frost, and are splendid for cutting. 2 ft.

- 7061 **Collection Large Flowering Varieties.** 6 colors..... .75
- 7062 **Crimson** ¼ oz. \$1.00 .15
- 7063 **Light Blue and Gold**... ¼ oz. \$1.00 .15
- 7064 **Frimrose** ¼ oz. \$1.00 .15
- 7065 **Purple, Golden Veined**... ¼ oz. \$1.00 .15
- 7070 **Rose, Golden Veined**... ¼ oz. \$1.00 .15
- 7075 **Scarlet, Golden Veined.** ¼ oz. \$1.00 .15
- 7078 **Velvet Violet** ¼ oz. \$1.00 .15
- 7080 **Large-Flowering, Mixed.** ¼ oz. \$1.00 .15
- 7090 **Dwarf, Mixed.** New class, 12 to 15 in. high, with larger flowers more freely produced than the tall growing25



Primula Malacoides

No.		Pkt.
	SALVIA. One of our handsomest and most showy summer and autumn flowering plants forming compact bushes, literally ablaze with brilliant flowers from July to frost.	
7098	America (Globe of Fre). 1/8 oz. \$1.25	\$0.25
7100	farinacea. Remarkable for its long flower spikes of lavender-blue. 3 ft. 1/8 oz. \$1.00	.15
7102	farinacea, Blue Bedder. Compact, deep blue; fine for bedding or borders 1/8 oz. \$1.50	.25
7103	horminum violacea. Half-hardy annual. 2 ft. Violet-blue..	.15
7105	patens. Rich blue. 2 ft. 1/8 oz. \$1.75	.25
7110	splendens, Bonfire. Finest compact sort of very even growth, with dense spikes of vivid dark flowers. 2 1/2 ft. 1/4 oz. \$1.50	.20
7115	splendens, Fireball. Compact sort, with large, scarlet flower spikes, early and rich flowering. 2 ft. 1/4 oz. \$1.75	.20
7118	Salmon-Pink. Blooms of large size and beautiful salmon-pink color on strong spikes. Blooms from mid-August until killed by hard frosts.35
7120	splendens grandiflora. Large, brilliant scarlet flower spikes. The most popular sort grown. 3 ft. . . 1/4 oz. \$1.00	.10
7122	splendens, Harbinger. Dwarf, compact dazzling scarlet, dark foliage. Seeded in February will flower in June. . .	.30
7130	splendens, Ostrich Plume. The spikes of flowers are like plumes; of the brightest scarlet, and the bush is well covered; each plume is a bouquet in itself25
7135	Zurich. The very earliest flowering variety; rich scarlet and suitable for pot growing; very dwarf. 1 ft. 1/8 oz. \$1.25	.25
7140	SANVITALIA procumbens fl. pl. Pretty free-flowering hardy annual, with double flowers of a bright yellow. 9 inches 1/4 oz. 75c	.15
	SAPONARIA. Compact growing, hardy annuals, with small starry flowers from July to September.	
7145	vaccaria. Beautiful pink feathery flowers. 3 ft. . 1/4 oz. 20	.10
7150	vaccaria alba. White-flowered; a fine market flower 1/4 oz. 20c	.10



Schizanthus

No.		Pkt.
	SCABIOSA, Improved Large-Flowering (Mourning Bride). One of our best summer flowering annuals. The rich and beautiful colored flowers are very handsome and excellent for cutting; profuse bloomer. June to Oct. 2 1/2 ft.	
7155	Azure Fairy. Delicate mauve . . 1/4 oz. 25c	\$0.10
7156	Blue Cockade. Pure deep azure-blue. 3 ft. 1/4 oz. 25c	.10
7158	Cattleya. Rich rosy lilac of the beautiful orchid tone 1/4 oz. 25c	.10
7160	Cherry Red. Bright color. 1/4 oz. 25c	.10
7165	Fiery Scarlet. Brilliant color. 1/4 oz. 35c	.10
7170	King of Blacks. Black purple. 1/4 oz. 25c	.10
7172	Giant Loveliness. Flowers salmon-rose shades. Fragrant 1/4 oz. 25c	.10
7175	Rose Pink. Beautiful shade . . 1/4 oz. 25c	.10
7178	Peach Blossom. Peach-blossom-pink 1/4 oz. 25c	.10
7180	Purple. Edged white 1/4 oz. 25c	.10

No.		Pkt.
	SCABIOSA—Continued.	
7182	Shasta. Enormous white California variety 1/4 oz. 25c	\$0.10
7186	Yellow 1/4 oz. 25c	.10
7190	Mixed. All colors 1/4 oz. 25c	.10
7195	Collection of 6 colors50
	SCABIOSA, Hardy Perennial Varieties. Of great value either in the border or for cutting. 2 ft.	
7200	caucasica. Beautiful lilac-blue. 1/4 oz. \$2.50	.15
7202	Columbaria. A low growing pink Scabiosa, very large flowers30
7203	caucasica, Isaac House Strain Hybrid . .	.35
7204	caucasica. Pure white25
7205	Large Flowered Hybrids25
	SCHIZANTHUS (Butterfly Flower). Beautiful annuals for house or garden.	
7208	Canadian Super-Giants. Largest flowers of any strain; blooms 2 inches across. Rich colorings and unusual markings. Sow in February under glass for summer use outdoors	1.00
7210	hybridus grandiflorus. Very fine new large flowered varieties 1/8 oz. 75c	.15
7215	Giant Hybrids (Garaways). A beautiful strain for greenhouses50
7218	Pansy-Flowered. Danbury Park Strain. Large blooms in great variety of rich self colors50
7220	wisetonensis. Containing the most delicate shades of white, pink, rose and crimson; excellent for pot culture 1-16 oz. \$2.00	.25
7221	wisetonensis. Dwarf, large flowering, mixed. Compact variety about 10 inches in height.25
7222	wisetonensis. Rose and amber shades.25
7225	Bridal Veil. Glistening snow white; very compact. 16 in.25
7228	Pink Pearl25
7229	roseus compactus. A fine greenhouse variety. . .	.60
7235	SEDUM (Stonecrop). Mixed. Suitable for rock work, edgings and dry situations; their glaucous foliage and bright flowers invariably attract attention; hardy perennial. 4 in. 1/8 oz. \$1.25	.20
7238	acre. Bright yellow. 3 in., hardy.25
7240	coeruleum. Blue-flowered annual variety.25
7241	spectabile. 1 ft. Perennial. Large lavender-pink flowers25
7245	SHAMROCK. True, small leaved variety; imported seed 1/4 oz. 50c	.10
7248	SIDALCEA hybrida. Hardy, 2 1/2 to 3 ft. June-July. In many shades of rose, pink, red, salmon, lilac and heliotrope25



Scabiosa
Blue
Cockade

No.		Pkt.
	SILENE (Catchfly). Very pretty and profuse blooming plants.	
7250	armeria, Mixed. Free flowering hardy annual, with pink, white and red flowers. 1 ft. ¼ oz. 25c	\$0.10
7255	pendula, Peach Blossom. Beautiful bright pink annual variety for spring bedding, edgings, etc. ¼ oz. 35c	.10
7260	orientalis. Fine hardy perennial with large globular heads of beautiful pink flowers; blooms from June to August and is fine for cutting; flowers first season from seed. 2½ ft. ¼ oz. 50c	.10
7265	SMILAX (<i>Myrsiphyllum asparagoides</i>). A climbing plant unsurpassed for its graceful foliage and orange blossom fragrance of its flowers.... ¼ oz. 35c	.10
7270	Myrtle-leaved. New and distinct form, more graceful than preceding 100 seeds 75c	.20
	SNAPDRAGON. See <i>Antirrhinum</i> .	
7275	SOLANUM capsicastrum nanum (Jerusalem Cherry). Very ornamental plants for house or greenhouse, being almost completely covered with bright scarlet berries. Early spring sown seed will produce fruiting plants in the autumn. 1 ft. ¼ oz. 50c	.10
7280	Cleveland. Very large, brilliant berries. A fine decorative plant	.15
7282	Blavacek's Masterpiece. Large scarlet. .	.15
7284	STATICE (<i>Sea Lavender</i>). Dumosa. Perennial, 2½ ft. Pure silvery grey.25
7285	Mixed. Beautiful hardy perennial	.10
7290	latifolia. Deep lavender-blue.. ⅛ oz. 40c	.10
7290A	sinuata, Annual Mixed. ¼ oz. 40c	.15
7291	sinuata, Blue ¼ oz. 40c	.15
7291A	sinuata, Lavender. ¼ oz. 40c	.15
7292	sinuata, Rose ¼ oz. 40c	.15
7293	sinuata, White ¼ oz. 40c	.15
7293A	suworowii (<i>Russian Statice</i>), Annual. Tail-like spikes of pink flowers	.15
7294	boduelli. Yellow	.15
	STEVIA. Free flowering greenhouse perennials, with sprays of tiny flowers. 2 ft.	
7295	eupatoria. Fine pinkish white. ⅛ oz. 35c	.10
7300	serrata. Pure white, fragrant	.15
	STOCKS (<i>Gilliflower</i>). One of the most highly prized of all our cultivated flowers. The delightful fragrance, free-blooming character and beautiful colors have made them as desirable for winter cultivation in the greenhouse as for the garden in summer.	
7302	Imperial Buttercup. Giant early, deep rich yellow ⅛ oz. \$1.50	.35
7303	Imperial Golden Rose. Giant early rich bright rose, golden sheen center. ⅛ oz. \$1.50	.35
	LARGE-FLOWERED DOUBLE GIANT PERPETUAL PERFECTION (Cut-and-come-again). An excellent variety of fine branching habit, with large double flowers in great abundance from June till frost. 2½ ft.	
7305	Apple Blossom Pink ⅛ oz. \$1.00	.15
7310	Bright Rose ⅛ oz. \$1.00	.15
7315	Canary Yellow ⅛ oz. \$1.00	.15
7320	Dark Blood Red ⅛ oz. \$1.00	.15
7325	Dark Blue ⅛ oz. \$1.00	.15
7330	Light Blue ⅛ oz. \$1.00	.15
7340	Snow White ⅛ oz. \$1.00	.15
7345	Mixed, Extra ⅛ oz. \$1.00	.15
7350	Collection of 6 colors. Our selection	.75

No.		Pkt.
	SPECIAL LARGE-FLOWERING PERFECTION OF NICE, TEN-WEEKS. Splendid strain for garden or greenhouse, of fine branching habit, with very large, double fragrant flowers. An unusually long and free blooming strain. 2 ft.	
7351	Collection of Six Separate Colors \$0.75	
7352	Almond Blossom. Shell-pink. .. ⅛ oz. \$1.00	.15
7353	Apricot Special Forcing. 2½ to 3 ft. Soft apricot, delicately tinged pink, large and fragrant	.35
7354	Belle of Naples. Old rose ⅛ oz. \$1.00	.15
7355	Beauty of Nice. Delicate flesh pink ⅛ oz. \$1.00	.15
7358	Mont Blanc. White ⅛ oz. \$1.00	.15
7362	Cote d'Azur. Light blue ⅛ oz. \$1.00	.15
7365	Crimson King. Rich crimson... ⅛ oz. \$1.00	.15
7370	Monte Carlo. Yellow ⅛ oz. \$1.00	.15
7375	Queen Alexander. Mauve ⅛ oz. \$1.00	.15
7376	Summer Night. Deep blue ⅛ oz. \$1.00	.15
7377	Violet of Nice. Dark violet ⅛ oz. \$1.00	.15
7378	Mixed ⅛ oz. \$1.00	.15
	MAMMOTH COLUMN TEN - WEEKS Splendid variety; earliest flowering of the Ten-Weeks Stocks; produces only one spike of large, double flowers 2½ ft.	
7380	Crimson ⅛ oz. \$2.00	.25
7390	Light Blue ⅛ oz. \$2.00	.25
7395	Rose Pink ⅛ oz. \$2.00	.25
7400	Snow White ⅛ oz. \$2.00	.25
	STOCK BISMARCK IMPROVED OR IMPERIAL. Large branching habit. Early forcing. 2½ ft.	
7401	Apple Blossom. ⅛ oz. \$1.00	.15
7402	Blood Red. ⅛ oz. \$1.00	.15
7403	Bright Rose. ⅛ oz. \$1.00	.15
7404	Dark Blue. ⅛ oz. \$1.00	.15
7406	Light Blue. ⅛ oz. \$1.00	.15
7407	Peach Blossom. ⅛ oz. \$1.00	.15
7409	White. ⅛ oz. \$1.00	.15
7411	Yellow. ⅛ oz. \$1.00	.15
7416	Mixed Colors. ⅛ oz. \$1.00	.15

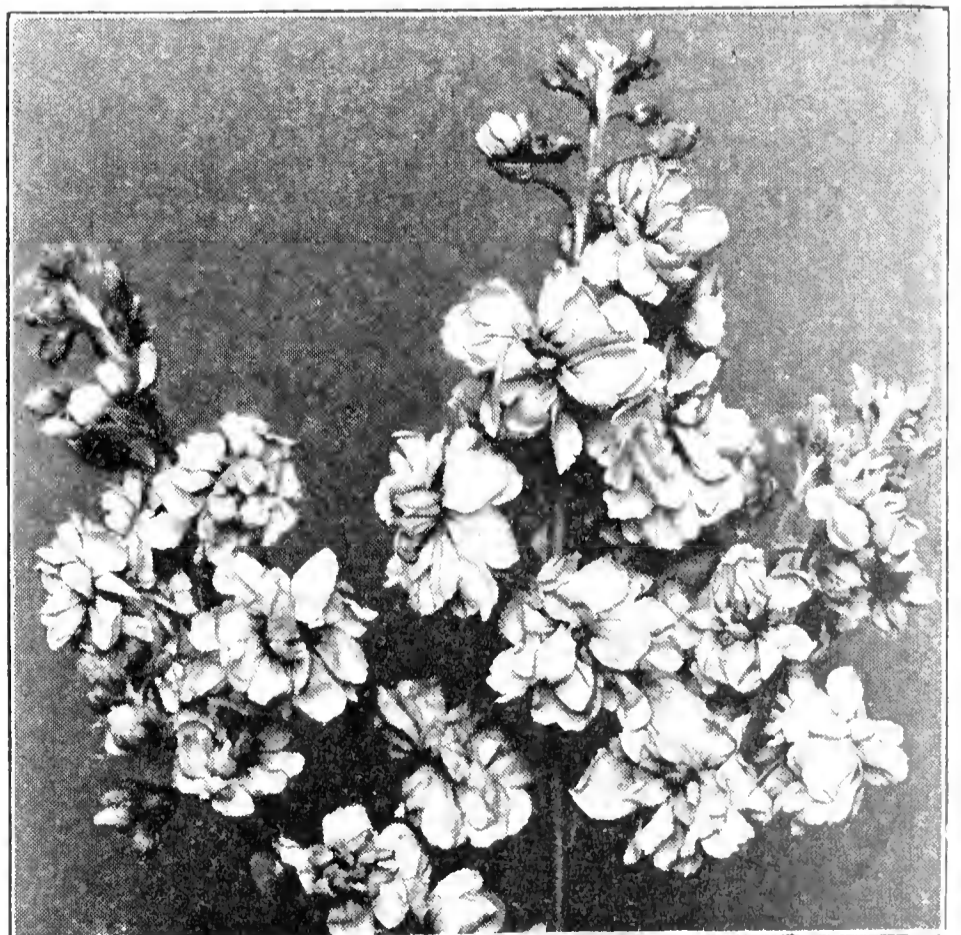

Double Giant Perpetual Perfection Stock

No.		Pkt.
	DWARF BOUQUET TEN-WEEKS. Dwarf Stock for growing in pots. 8 in.	
7417	Crimson. Fine deep color 1/8 oz. \$1.00	\$0.15
7418	Dark Blue 1/8 oz. \$1.00	.15
7419	Pure White. Excellent 1/8 oz. \$1.00	.15
7420	Light Blue 1/8 oz. \$1.00	.15
7421	Light Rose 1/8 oz. \$1.00	.15
7422	Mixed. All colors 1/8 oz. \$1.00	.15
7423	STOKESIA cyanea (Cornflower Aster). Beautiful hardy perennial with lavender-blue blossoms July to frost. 16 in. 1/4 oz. \$1.50	.25
7424	cyanea. Mixed15
7425	STREPTOCARPUS, Veitch's New Hybrids. Handsome greenhouse perennial, with Achimene-like flowers in clusters on slender stems. Treatment same as for Gloxinia75
	SUNFLOWER. See Helianthus.	
	SWAINSONA. Fragrant, tender perennial for house or conservatory. Graceful foliage and Sweet Pea-like flowers. Grown as a climber or trimmed into bush form. Usually grown in pots.	
7434	Grandiflora. Finest mixed50

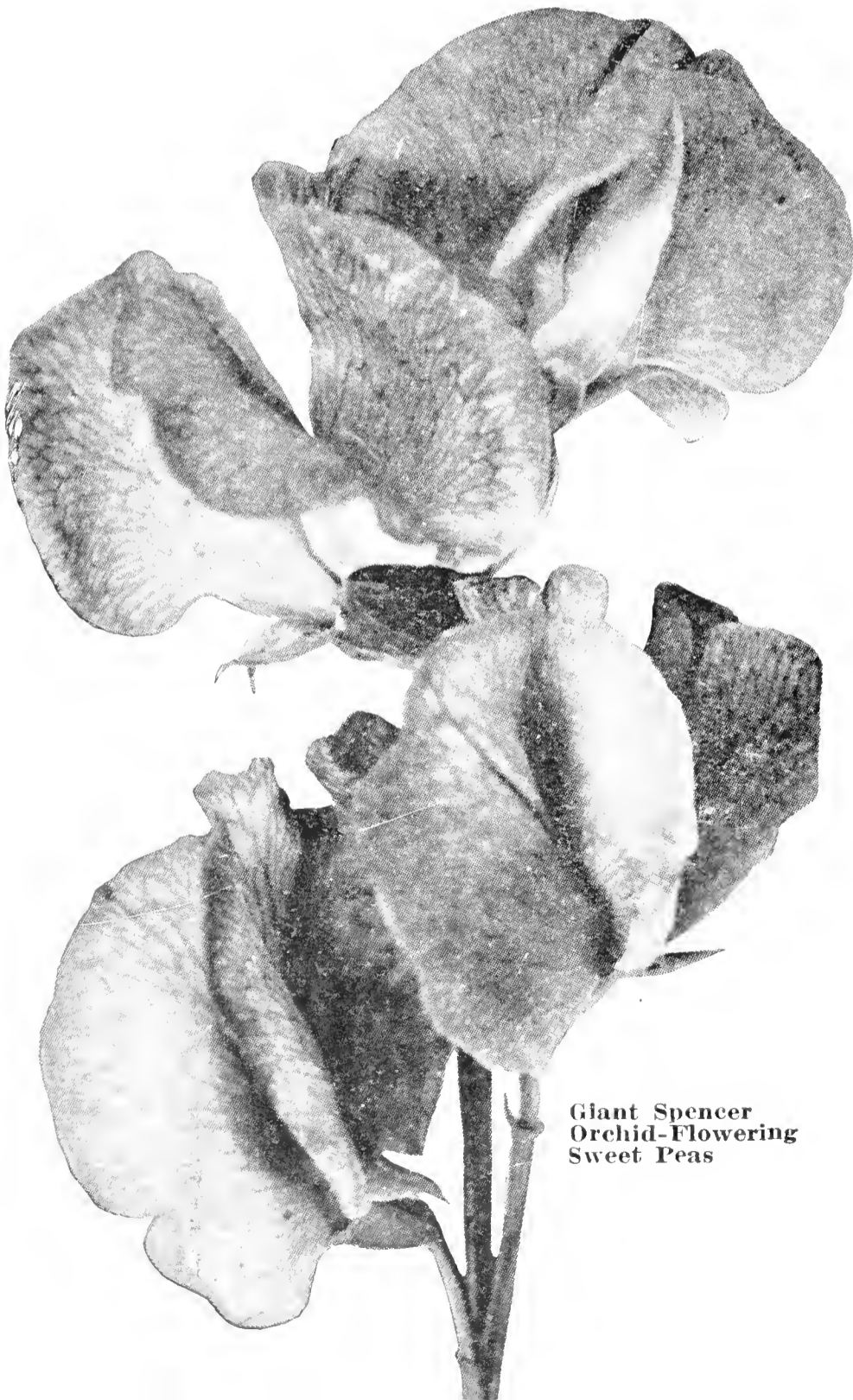

Giant Spencer
Orchid-Flowering
Sweet Peas

SWEET PEAS

No.		Pkt.
	GIANT SPENCER or ORCHID FLOWERING. Unquestionably the finest type of this most popular flower that has ever been introduced. The waved flowers are of immense size, usually 2 in. or more across and with three to five flowers on a stem. The season of bloom is much longer than the old type. Grow 3 or 4 in. apart in the rows.	
7450	Special Exhibition Mixture. This mixture is made up entirely of the Spencer types and includes the finest sorts and most effective colors; it is without equal and cannot fail to give the greatest satisfaction. Oz. 35c, 1/4 lb. \$1.00, lb. \$3.25	\$0.10
	Separate Varieties. Oz. 50c, 1/4 lb. \$1.50, unless otherwise priced.	
7465	Austin Frederick Improved. Giant true lavender10
7470	Avalanche. Glistening white10
7475	Barbara. Large salmon10
7475A	Begonia Rose.Oz. 60c	.15
7476	Bon Bon. Rich pink shading amber. Oz. 60c	.15
7480	Bonfire. Cherry-pink, cream wings.....	.10
7485	Campfire. Bright scarlet10
7498	Cattleya Queen. Orchid.....Oz. 60c	.15
7505	Charming. Deep cerise10
7510	Chieftain. Deep satiny mauve10
7512	Chinese Blue. Rich deep blue....Oz. 60c	.15
7515	Colorado. Bright orange10
7520	Constance Hinton. Mammoth white, black seeded10
7535	Defiance. Orange-scarlet10
7555	Flamingo. Scarlet-cerise10
7560	Fortune. Dark blue10
7565	Gleneagles. Light blue-lavender10
7570	Glengarry. Deep velvety crimson.....	.10
7575	Grand National. Rich cream.....	.10
7580	Hawlmak Cerise10
7585	Hawlmak Lavender10
7590	Hawlmak Pink10
7595	Hawlmak Salmon10
7600	Hawlmak Scarlet10
7605	Heavenly Blue. Delphinium blue10
7610	Hebe. Bright pink10
7615	Huntsman. New shade scarlet10
7620	International. Rosy Mauve.....	.10
7625	King White. Giant pure white.....	.10
7645	Mary Pickford. Dainty cream-pink.....	.10
7655	Mermaid. Blue-lavender10
7660	Model. Large white, black seeded10
7665	Mrs. A. Searles. Pink, merging to red ..	.10
7670	Mrs. Tom Jones. Delphinium-blue10
7675	Olympia. Deep purple10
7680	Picture. Pink, shaded creamy apricot...	.10
7685	Pinkie. Large rose-pink10
7688	Pirate Gold. Golden orangeOz. 60c	.15
7690	Powerscourt. Lavender10
7700	Reflection. Clear blue10
7702	Ripples. Rose-pink, wavy semi-duplex..	.10
7710	Royal Purple10
7725	Smiles. Salmon-shrimp-pink10
7730	Sunkist. Cream picotee rose10
7740	Sybil Henshaw. Deep crimson10
7755	Warrior. Giant red-maroon10
7765	What Joy. Primrose yellow10
7770	Winnie Morse. Duplex frilled, cream ground, flushed roseOz. 60c	.15
7775	Youth. White picotee rose10

No. Pkt.

SPENCER VARIETIES FOR GREENHOUSE

All white seeded varieties will germinate better if sown in small pots of sand, being less liable to decay and can readily be transplanted to permanent place.

¼ oz. 35c, oz. \$1.00 each, unless priced.

7808	Annie Laurie. Rose-pink.....	\$0.15
7810	Aviator. Dazzling crimson-scarlet15
7811	Ball Blue. Clear blue15
7812	Ball Orange. Rich, deep color15
7812A	Ball Rose Imp. Sparkling rose-pink....	.15
7818	Blue Bonnet. Extra large, clear blue ..	.15
7820	Burpee's Orange.15
7825	Claret Cup. New, pansy-purple..Oz. \$1.25	.25
7831	Eileen. Rich flaming golden rose15
7832	Eldorado. Rich salmon-orange15
7833	Enchantress Rose Pink15
7833A	Exposition Pink	oz. \$1.25 .25
7834	Fragrance. Clear lavender.....	.15
7835	Glitters. Cerise15
7838	Gloria. Sparkling salmon-rose.....	.15
7840	Grenadier. Dazzling scarlet15
7842	Hope. Mammoth black-seeded white....	.15
7842A	Josie. New. Longest stemmed rose-pink. Oz. \$1.50	.25
7843	Laddie Rose-pink, white ground15
7844	Lavanda. Clear lavender.....	.15
7845	Lavender Harmony. Clear lavender15
7852	Majestic Rose. Brilliant deep rose.....	.15
7857	Mrs. Herbert Hoover. Bright blue.....	.15
7870	Prosperity. Orange-salmon15
7873	Sequoia. Rich golden cerise....oz. \$1.50	.25
7874	Shirley Temple. Rich soft pink frilled fluted, flowers very large, usually four on each stem.....oz. \$1.25	.25
7892	Valencia. Bright orange, sunproof.....	.15
7895	White Harmony. Black-seeded white15
7910	Mixed, All Varieties .. ¼lb. \$1.50, oz. 50c	.15

SWEET ROCKET. See *Hesperis*.

SWEET SULTAN. See *Centaurea*.

SWEET WILLIAM. Popular and showy hardy biennial of easiest culture, producing their brilliant colored flowers in great profusion; very desirable for borders and old-fashioned gardens 1½ ft.

8055	Boston Giant. An extraordinary strain with flowers as large as a half dollar and contains colors not in other strains25
------	--	-----

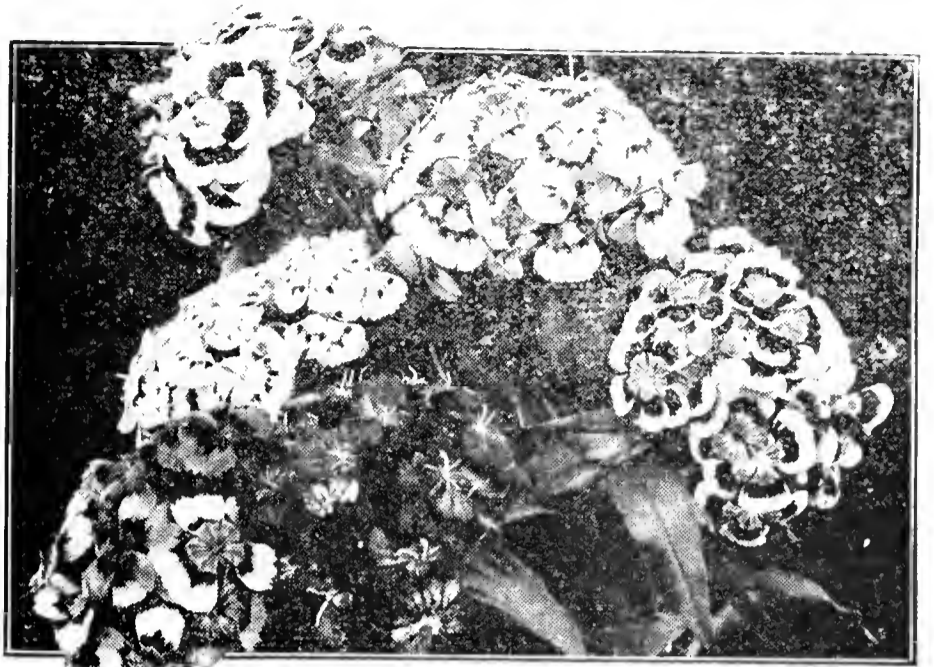

Sweet William, Boston Giant

No.		Pkt.
8060	Double Mixed. Very large flowers in choice colors	¼ oz. 75c \$0.15
8065	Holborn Glory. Extra large flowers, finest colors, with clearly defined eyes	¼ oz. 50c .10
8070	Single Finest Mixed	¼ oz. 50c .10
8075	Dark Crimson	¼ oz. 50c .10
8080	Deep Velvety Maroon	¼ oz. 75c .10
8082	Newport Pink. Beautiful salmon-pink.25
8085	Pure White	¼ oz. 75c .10
8090	Pink Beauty. Soft pink	⅛ oz. 75c .25
8095	Scarlet Beauty. Vivid	⅛ oz. 75c .25
8100	Annual Mixed. Flowers of good size and well marked; seed sown in March will bloom the same year. 9 in. ..	¼ oz. 75c .15
8102	THALICTRUM diptercarpum. 3½ ft. Ornamental foliage and sprays of dainty graceful flowers of violet-mauve with yellow stamens and anthers. Fine for cutting15
8103	THERMOPSIS caroliniana. Long spikes of bright yellow flowers. Perennial. 4 ft..	.25
	THUNBERGIA (Black-eyed-Susan). Beautiful free flowering annual twiners of rapid growth, used extensively in window boxes, vases, etc. 4 ft.	
8105	alata. Yellow, with dark eye....	¼ oz. 65c \$0.10
8110	alba. White, with dark eye....	¼ oz. 65c .10
8115	aurantiaca. Orange, with dark eye	¼ oz. 65c .10
8120	Mixed. All colors	¼ oz. 50c .10
8123	TITHONIA speciosa. Golden flower of the Incas. Annual 6-8 ft. tall, fine for background planting. Flowers single orange-vermilion, similar in growth to a dahlia25
	TORENIA. Beautiful free flowering, tender annuals, suitable for pot culture in house or conservatory, also excellent for the border during the summer, and for baskets and vases are unsurpassed. June to October. 1 ft.	
8125	bailloni. Golden yellow, purple throat..	.25
8130	fournieri grandiflora. Bright blue, with dark blue spots, bright yellow throat..	.25
8135	White Wings. Blush-white, yellow throat.	.25
8140	TRITOMA semperflorens (Flame Flower). Perpetual flowering, showy perennial, with numerous spikes of orange-red flowers from July until frost; excellent for beds or borders. 3 to 4 ft...	.15
8145	hybrida mirabilis. New dwarf annual strain ranging in color from lemon-yellow to deep orange. Sown early and planted out in May, they bloom freely from July until frost. 2 ft.15

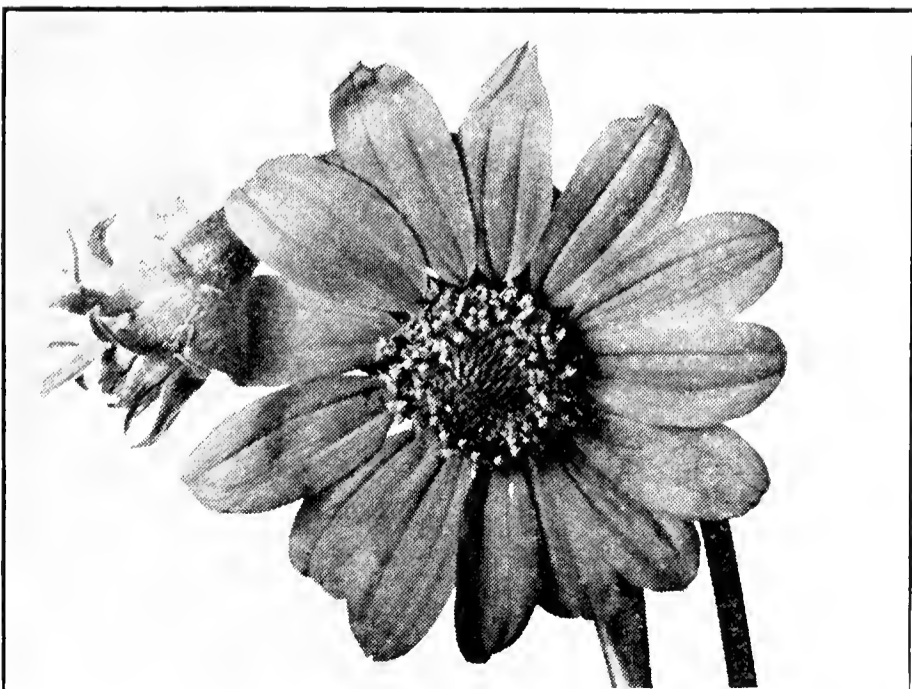

Tithonia speciosa

No.		Pkt.
	TROLLIUS (Gloflower). Charming spring flowering, hardy perennials, with large globular Buttercup-like flowers.	
8150	Orange Globe. Large, deep orange	\$0.25
8155	Mixed Hybrids. Newest large flowered varieties25
8160	TROPAEOLUM canariense (Canary-creeper). Well-known climbing annual with elegantly fringed, bright yellow flowers. 10 ft.	Oz. 50c .10
8163	URSINIA anethoides. Pretty daisy-like flower from South Africa, color bright orange with a purple zone. Height about 10 inches25
8164	aurora. A dwarf variety with brilliant orange flowers with a broad zone of deep crimson in the center25
8165	VALERIAN, Mixed. Showy, hardy perennial with long spikes of heliotrope-scented flowers. 2 ft.	¼ oz. 35c .10
8170	officinalis (Garden Heliotrope). Large trusses of fragrant pink flowers. 3 ft.25
8173	VENIDIUM fastuosum. Annual. 2-3 feet. Deep orange daisy-like flowers 4-5 inches across with upper row of petal marked with reddish brown zone.25
8174	VERBASCUM phoeniceum Hybrids. A superior strain of these excellent hardy perennials. Plants 3 ft. high with colors ranging from white, pink, rose, purple and bronze to brown	¼ oz. 35c .15
	VERBENA. These are invaluable for summer bedding purposes. Seed sown in March will commence to bloom in June and continue until frost. 1½ ft.	
8175	Grey's Mammoth, Mixed. A grand strain of giant Verbenas, with flowers of exceptional size	¼ oz. 75c, oz. \$2.50 .10
8176	Auricula-flowered Mixed. Large flowers with white eye.	¼ oz. 60c .10
8177	Beauty of Oxford Hybrid. Rose-pink shading to rose-red.	⅛ oz. 50c .25
8178	Blue. White eye.	Oz. \$2.50, ¼ oz. 75c .10
8179	Dwarf compacta Mixed.	⅛ oz. 50c .20
8182	Etna. Geranium red, yellow eye.	⅛ oz. 50c .15
8183	Giant Apple Blossom.25
8184	Giant Salmon Pink.	¼ oz. 75c .15
8187	Golden Queen.	¼ oz. 75c .15

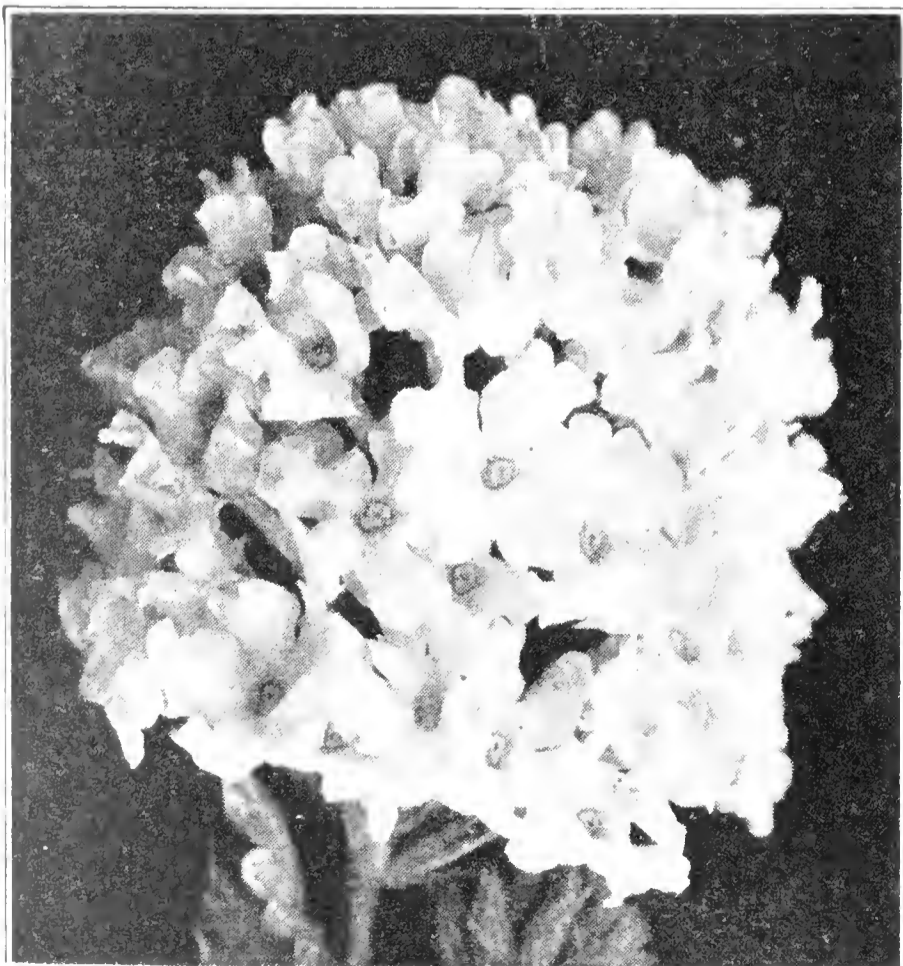

Grey's Mammoth Verbena.



No.	Viola Cornuta.	Pkt.
8191	Helen Willmott. Salmon-pink, white eye.	¼ oz. 75c \$0.15
8193	Lavender Glory. Creamy white eye, fragrant	⅛ oz. 50c .25
8193A	Mayflower Pink	¼ oz. 75c .10
8194	Rose Queen	⅛ oz. 60c .20
8195	rosea stellata. Rose, white eye.	¼ oz. 75c .10
8197	Royale Hybrida. Royal blue, yellow eye.	⅛ oz. 60c .20
8200	Scarlet Lucifer	¼ oz. 75c .10
8202	Scarlet Queen. Very large	⅛ oz. 60c .20
8203	Snow Queen. Very large	⅛ oz. 60c .20
8208	Spectrum Red. Intense bright scarlet, no eye	⅛ oz. 75c .25
8209	Violet Bouquet. 8 in. Deep violet, cream eye25
8210	White hybrida	¼ oz. 75c .10
8212	Erinoides (Moss Verbena). 1 ft. Purple.15
8214	erinoides alba. 1 foot.	⅛ oz. 30c .15
8215	Lemon Verbena (Aloysia citriodora). Fragrant foliage for cutting25
8221	venosa lilacina.	⅛ oz. 50c .25
8222	venosa. Purple	¼ oz. 50c .15
	VERONICA. Splendid hardy perennials, with showy spikes of bright colored flowers; fine border plant. 1½ to 2 ft.	
8224	longifolia. 2½ ft. Compact clusters of blue flowers15
8225	spicata Blue. Bright blue20
8227	spicata, Mixed20
	VINCA. Handsome, profuse blooming half-hardy perennials, flowering the first season from seed.	
8235	Bright Rose	¼ oz. 75c, oz. \$2.50 .15
8240	Pure White	¼ oz. 75c, oz. \$2.50 .15
8245	White, with Rose Eye ¼ oz. 75c, oz. \$2.5015
8250	Mixed. All colors	¼ oz. 75c, oz. \$2.50 .15
	VIOLA cornuta (Tufted Pansies). Fine flowering plants, excellent for partially shaded beds or borders, blooming throughout the season; hardier than other Pansies, but with smaller flowers.	
8255	Admiration. Rich, dark blue.	¼ oz. \$1.75 .15
8260	Blue Perfection. Light blue.	¼ oz. \$1.75 .15
8265	lutea. Old yellow sort	¼ oz. \$1.50 .15
8265A	Mauve Queen15
8266	Papilio Deep Violet15
8270	rosea. Delicate rose	¼ oz. \$1.75 .15
8275	White Perfection. Large white.	¼ oz. \$1.50 .15
8280	Mixed. Finest varieties	¼ oz. \$1.25 .15
8282	Arkwright Ruby. New, fragrant bedding Viola. Color terra cotta markings on crimson25
8285	Scotch Strains. Choicest and newest bedding hybrids in finest colors.25
8287	Sutton's Bedding Apricot. Rich apricot.35
8288	Viola, Jersey Gem. A large, deep violet-blue; fine for rockery and border.35
8290	Lavender Gem (Cornuta). Color soft deep lavender. Plants of compact habit bearing a continuous profusion of long lasting bloom50

No.		Pkt.
	VIOLA odorata (Sweet scented Violet). Hardy perennial, easily grown from seed, doing best in cool, moist situation.	
8295	The Czar. Very large dark blue. 1/8 oz. 85c	\$0.15
8300	White Czar. Very large white. 1/8 oz. 75c	.15
8305	Mixed. Blue and white shades. 1/8 oz. 50c	.10
8310	VIRGINIAN STOCK, Mixed. 1/4 oz. 75c	.15
8312	Crimson Gem. 8 in. Erect and compact.	.15
8315	VISCARIA, Finest Mixed. Showy, free flowering hardy annual, for border or masses. The bright flowers are continued through the season. 1 ft. 1/4 oz. 25c	.10
	WALLFLOWER. Delicately fragrant half-hardy perennials, with beautiful velvety flowers.	
8320	Double Branching, Mixed. 1/4 oz. \$1.50	.25
8325	Kewensis. Very fragrant flowers varying from sulphur-yellow to orange and purple-violet 1/4 oz. \$1.50	.25
8330	Vulcan. Velvety crimson-brown flowers. 1/4 oz. 60c	.15
	WALLFLOWER, Annual. Early flowering single varieties which bloom throughout the summer from spring-sown seed.	
8335	Blood Red 1/4 oz. 50c	.25
8340	Earliest Paris. Fine brown. 1/4 oz. 50c	.25
8345	Golden Yellow 1/4 oz. 50c	.25
8350	Mixed. All colors 1/4 oz. 50c	.15
8352	Double Early Wonder Mixed. 2 ft. Blooms within 3 months. 1/4 oz. 50c	.15
8365	XERANTHEMUM, Double Mixed. Suited to drying as everlasting. 1/4 oz. 50c	.15
8370	YUCCA filamentosa (Adam's Needle). Hardy perennial. The large, white, waxy flowers of drooping habit are borne in huge panicles above the sword-shaped foliage during July and August. 1/4 oz. 75c	.15
8374	ZEA japonica Rainbow. Green white, rose and yellow striped foliage. 5 ft. Oz. 25c	.10
	ZINNIA. These attractive and decorative hardy annuals are most desirable for borders or bedding; remarkable for the profusion and duration of their flowers, in bloom from June to frost.	
	Giant Dahlia-Flowered. 1/8 oz. Pkt.	
8375	Collection. 12 varieties	\$1.50
8380B	Canary Bird. Delicate primrose...	.35 .15
8381	Crimson Monarch35 .15
8382	Dream. Deep lavender35 .15
8382A	Eldorado. Rose on deep salmon..	.35 .15
8383	Exquisite. Light rose, deep center.	.35 .15
8383A	Golden Dawn. Golden Yellow...	.35 .15
8384	Golden State. Orange-yellow35 .15
8384A	Illumination. Deep rose self color.	.35 .15
8384B	Lemon Beauty. Pastel shade....	.35 .15
8384C	Luminosa. Bright deep pink, light suffusion of salmon35 .15
8385	Meteor. Glowing deep red35 .15
8385A	Old Rose. A real old rose color ..	.35 .15
8385B	Old Gold35 .15
8386	Oriole. Orange and gold35 .15
8387	Polar Bear. Pure white35 .15
8387A	Purple Prince. A deep purple35 .15
8387B	Scarlet Flame. Bright scarlet35 .15
8387C	Youth. Light pink35 .15
8388	Special Mixture35 .15
	Double Giant Flowering Columbia Strain. Saved from selected prize flowers. 2 ft. 1/4 oz. Pkt.	
8389	Bright Rose	\$0.50 \$0.10
8389A	Burnt Orange50 .10
8390	Cardinal50 .10
8395	Crimson50 .10
8400	Deep Ruby Red50 .10
8405	Flesh Pink50 .10
8410	Golden Yellow50 .10
8415	Light Canary50 .10
8420	Violet50 .10
8425	Scarlet50 .10
8430	Salmon Rose50 .10
8435	White50 .10

No.		1/4 oz.	Pkt.
8440	Columbia Prize Mixture	\$0.50	\$0.10
8442	Pastel Shades, Mixed50	.10
8445	Collection of 6 Colors50
8446	Desert Gold (Crown of Gold type). Light and deep hues of gold, each petal overlaid at the base with a deeper golden yellow.... 1/8 oz. 50c		.20
8447	Fantasy Mixed. A mixture of bright and pastel shades of shaggy petaled, medium sized double flowers 1/8 oz. 50c		.20
8448	Scabiosa-Flowered Mixed. Plants 2 to 2 1/2 ft. Flowers medium sized. 1/8 oz. 50c		.20
8450	Dwarf Crimson. 1 ft.50	.10
8455	Bright Rose Pinkie (New)50	.10
8458	Canary Yellow50	.10
8460	Carmine50	.10
8465	Dazzling Scarlet50	.10
8470	Flesh Pink50	.10
8475	Golden Orange50	.10
8478	Salmon Rose50	.10
8480	White50	.10
8485	Mixed. All colors50	.10
8490	Collection of 6 Colors50
	EARLY WONDER		
	A new race of dwarf early flowering Zinnias producing masses of medium size flowers on nearly leafless stems. 1/8 oz. Pkt.		
8498	Fandango. Fiery salmon-cerise ...	\$0.40	\$0.20
8499	Gypsy. Deep burnished orange.... 1/8 oz. 40c		.20
8502	Gracillima. Dwarf Red Riding Hood. .50		.10
8504	Lilliput, Tom Thumb Mixed. Plants are only 4 to 6 inches high, and are covered with well formed flowers of the Lilliput type in all colors 1/8 oz. 50c		.20
8505	Lilliput, Mixed. Very small double fine for borders. 1 1/2 ft.	\$0.50	\$0.15
8508	Canary Yellow.50	.15
8510	Crimson Gem. Deep crimson50	.15
8512	Deep Flesh.50	.15
8515	Golden Gem. Golden yellow50	.15
8516	Lilac Gem.50	.15
8517	Rosebud. Rose-pink.50	.15
8518	Salmon Rose Gem50	.15
8520	Scarlet Gem. Dazzling scarlet ..	.50	.15
8522	Valencia. Burnt orange.50	.15
8525	White Gem. Pure white....	.50	.15
8526	Collection 6 colors75
	1/8 oz. Pkt.		
8527	Pumila Picotee, Delight. A dwarf double type in shades of salmon, yellow and lavender, flowers not so large and stems more slender than the ordinary type; extra fine for cut flowers. \$0.50 \$0.20		
8528	Double Mexican, haageana hybrida Mixed. 1 ft. Small, double blooms of unusual coloring ...	\$0.50	\$0.15
8529	Single Mexican Hybrids Mixed30	.10
	CALIFORNIA GIANTS. The flowers are very graceful, of large size and flat, with a small, flat center. Height 3 to 4 ft.		
8600	Cerise Queen35	.15
8605	Daffodil. Canary-yellow35	.15
8610	Enchantress. Light rose, deeper rose center35	.15
8615	Golden Queen. Golden lemon35	.15
8620	Grenadier. Bright dark red35	.15
8625	Lavender Gem. Deep lavender ..	.35	.15
8630	Miss Willmott. Soft pink35	.15
8635	Orange Queen. Golden orange ..	.35	.15
8640	Purity. White35	.15
8645	Salmon Queen. Salmon-rose35	.15
8650	Mixed Colors35	.15
8660	Collection of 10 Separate Varieties		1.25

Mixed Flower Seeds for Wild Gardens

"Wild Gardens" have proved a marked success, and we are in receipt of the most satisfactory evidence of the estimation in which they are held. Anyone who has cultivated flowers knows the constant attention necessary in the care of well laid out beds and borders. To those who cannot give this care, the "Wild Garden" presents a substitute which, for its unusual and varied effects, cheapness, and the small amount of labor necessary for its construction, has no rival. "Wild Garden" seeds are a mixture of over one hundred varieties of flower seeds, and, being mixed together can be offered at a much less price than when sold in separate packets. The different seasons of bloom insure something new almost every day.

8530 **Dwarf Sorts.** ½ oz. pkts., each 15c, oz. 25c, 4 ozs. 85c, lb. \$2.50.

8535 **Tall Sorts.** ½ oz. pkts., each 15c, oz. 25c, 4 ozs. 85c, lb. \$2.50.



Dirt-Proof, Washable GARDEN GLOVES

All Leather
Durable
Easy to Wear
—for Men and Women

Easy Wear gives you everything you want in a garden glove: all-leather protection from dirt, scratches, stains, infection—yet permit almost BAREHAND FREEDOM. Their amazing softness and pliability are the result of a special processing of select lamb skins. Economical, too—outwear 6 pairs of ordinary fabric gloves, are washable and can be used the year round for gardening, housework, painting, furnace, garage, etc.

Sizes for WOMEN and MEN.
Price 75 Cents a Pair.

EEZY Wear
HOME GLOVES

KREME SKIN BEAUTY GLOVES (Cream treated). Made of extra-soft, imported lamb skins specially treated to give them a moderate lanolin (cold cream) content. They beautify the hands while you work or play. \$1.00 a pair.

GENUINE HORSEHIDE PRUNING GLOVES. \$1.50 a pair. With gauntlets, \$2.00 a pair.



Ornamental Grasses

For borders and ornamental gardening; also, when dried, for winter bouquets and decorations, for which purpose they should be gathered before fully matured.

No.		Pkt.
8670	Finest Mixed. In great variety, for bouquets	\$0.10
8675	Avena sterilis (Animated Oats). Annual. 1½ ft.10
8680	Arundo donax variegata. Variegated foliage; half-hardy perennial. 7 ft.10
8685	Briza maxima (Quaking Grass). Annual. 1 ft.10
8690	Bromus brizaeformis. Drooping; annual. 1½ ft.10
8695	Coix lachryma (Job's Tears). Striped leaves; annual. 2 ft.10
8700	Eulalia japonica zebrina. Beautiful variegated leaves with yellow bars running crosswise; half-hardy perennial. 5 ft.10
8705	Gynerium argenteum (Pampas Grass). Large, silvery plume; half-hardy perennial, 10 ft.10
8710	Hordeum jubatum (Squirrel's Tail). Annual. 2 ft.10
8715	Lagurus ovatus (Hare's Tail). Annual. 1 ft.10
8720	Pennisetum ruppelianum. Beautiful crimson-purple plumes, from spring-sown seed15
8725	Stipa pennata (Feather Grass). 2 ft.15



Gynerium argenteum—Pampas Grass

Specialties in Vegetable Seeds

All prices subject to change without notice.

Pedigreed Asparagus

MARY WASHINGTON. It is earlier, produces more, has larger stalks, possesses highest rust resistance and will net a great deal more money per acre than the Martha Washington. Selected Asparagus roots, \$2.25 per 100, \$20.00 per 1000. Seed, pkt. 10c, oz. 50c, ¼ lb. \$1.50.

Beans

ASGROW VALENTINE. An extremely early entirely stringless Bean. Pods 6½ to 7 in. long and of excellent flavor. Lb. 35c, 2 lbs. 60c.

McCREA'S BUSH LIMA. A very early variety of excellent quality and flavor. The vines are strong and wilt-resistant. We strongly recommend a trial of this splendid variety. Lb. 40c, 2 lbs. 75c.

MASTERPIECE STRINGLESS BUSH. A fine variety for exhibition and for those who demand quality. Lb. 40c, 2 lbs. 75c.

THE PRINCE (Sutton's). A first early variety producing a heavy crop of long, meaty pods, often measuring from 11 to 12 in. in length. Absolutely stringless and of excellent flavor. Pkt. 35c, lb. \$1.50, 2 lbs. \$2.50.

Beet

EARLY WONDER. It is an ideal all-season Beet, for while it grows a nice size it retains its tender quality throughout the season. Pkt. 10c, oz. 25c; ¼ lb. 75c.

CROSBY'S EGYPTIAN SELECTED (Arlington Strain). One of the earliest dark leaved varieties; fine quality. Pkt. 15c, oz. 50c, ¼ lb. \$1.50, lb. \$4.00.

Cabbage

CHINESE CABBAGE, CHIH LI. For fine quality, earliness and sure heading, this variety is unsurpassed. Pkt. 10c, oz. 35c, ¼ lb. \$1.25.

DANISH BALLHEAD. A Winter Cabbage. Extra hard-headed of fine quality. Pkt. 10c, oz. 40c, ¼ lb. \$1.25.

THE GOLDEN ACRE. A new Cabbage, head measuring 9 in. in diameter; 10 days earlier than Copenhagen Market and more compact. Pkt. 10c, oz. 40c.

Carrot

AMSTERDAM FORCING (Coreless). The roots are blunt ended, flesh is crisp, sweet, and extremely fine grained. Pkt. 10c, oz. 25c, ¼ lb. 75c.

DANVERS HALF-LONG IMPROVED. Special strain. Grown for us by a leading Carrot specialist. Pkt. 15c, oz. 50c, ¼ lb. \$1.50.

IMPERATOR. An outstanding variety, the roots average about 8 inches long, the flesh is of a rich orange color, fine grained, tender, and of fine quality. Pkt. 10c, oz. 25c, ¼ lb. 75c, lb. \$2.25.

PRIDE OF DENMARK. A wonderfully fine Carrot. It closely resembles the Hutchinson, but has less core and deeper color. Pkt. 15c, oz. 50c, ¼ lb. \$1.50.

Cauliflower

EARLY SIX WEEKS. A very early variety; the heads are pure white, very firm, solid, and of the finest quality. Excellent for forcing. Pkt. 25c, oz. \$5.00, ¼ lb. \$14.00.

Celery

GIANT PASCAL (Arlington Strain). This is the most profitable Celery for fall or winter use, thick, solid, crisp and of rich, nutty flavor. Pkt. 10c, oz. 50c, ¼ lb. \$1.75.

GOLDEN PLUME. It is considered by many gardeners the best of all early varieties. Pkt. 10c, oz. \$1.00, ¼ lb. \$3.50.

EASY BLANCHING. The plants make a rapid and vigorous growth, producing rather thick, solid stalks of excellent quality and rich, nutty flavor. Pkt. 15c, oz. \$1.50.

Sweet Corn

ASGROW GOLDEN COLONEL. A golden yellow late variety. Grows 7 to 8 feet tall; the ears are large; deep kernels of fine quality and very sweet. Pkt. 25c, lb. 70c, 2 lbs. \$1.25.

GOLDEN CROSS BANTAM. Ears 7 to 8 inches long, 10 to 14-rowed. Slightly lighter yellow than Golden Bantam. Sweet and of fine flavor. Pkt. 25c, lb. 60c, 2 lbs. \$1.00.

GREY'S MINIATURE WHITE CORN. This extra early variety requires very little garden space, and may be grown successfully in the greenhouse. Of fine quality and very sweet. Supply limited. Pkt. 35c, ¼ lb. 60c, lb. \$2.00.

Lettuce

MAY KING (Selected Strain). As a Lettuce for greenhouse forcing, this is the best; the heads form very quickly and are firm and of fine quality. Pkt. 15c, oz. 75c, ¼ lb. \$2.00.

SUTTON'S SUPREME. A fine Lettuce of the Drumhead type. Leaves prettily edged with red. Pkt. 25c.

WHITE BOSTON. A sure, hard heading variety, the heart and inner leaves are a rich yellow, of splendid quality. Pkt. 10c, oz. 50c, ¼ lb. \$1.50.

Melons

BLENHEIM ORANGE. Handsome scarlet flesh, superb flavor. Pkt. 50c.

DELICIOUS. An early variety well named Delicious. The fruits are large, creamy yellow when ripe and covered with fine netting. Flesh deep orange color and very sweet. Pkt. 10c, oz. 35c, ¼ lb. \$1.00.

GREY'S SELECTED A-1. Flesh deep orange color, very thick and sweet with a delicious flavor, large size and very productive. Pkt. 25c, oz. \$1.00, ¼ lb. \$3.00.

HEARTS OF GOLD. A splendid small, midseason variety. Flesh very thick, deep salmon color, and of high quality; a good shipping Melon. Pkt. 10c, oz. 25c, ¼ lb. 75c.

HERO OF LOCKINGE. Fruit handsome, flesh white, extremely rich in flavor. Pkt. 50c.

SUPERLATIVE. Flavor exceptionally fine, scarlet flesh, round fruits; very productive. Pkt. 50c.

Before planting
Beans, inoculate
seed with

NITRAGIN



The Golden Acre Cabbage

Specialties in Vegetable Seeds

Onions

AILSA CRAIG. A handsome variety. Globe-shaped, flesh white, with pale yellow skin. A favorite for exhibition. Pkt. 25c, oz. \$1.00.

CRANSTON'S EXCELSIOR. Handsome, globe-shaped variety, large, solid with small neck, straw color; an exhibition variety. Pkt. 25c, oz. \$1.00.

DANVERS YELLOW GLOBE (Selected Strain). The finest type of this popular variety in the market. Grown for us by an Onion specialist. Pkt. 25c, oz. \$1.00, ¼ lb. \$3.00.

Peas

SUTTON'S SUPER V. C. The largest podded Pea in existence; height from 5 to 6 ft., large pods of fine flavor; an exhibition variety. Lb. 75c, 2 lbs. \$1.40.

THE BRITISHER PEA. A prolific, strong growing variety with medium green foliage. Pods are perfectly straight, pointed at the ends, and of a medium green color, containing nine, large, nicely flavored Peas. 4 ft. Main crop; wrinkled. Pkt. 35c, lb. \$1.25, 2 lbs. \$2.00.

THE MIRACLE. An early main crop, wrinkled variety. Height 4 feet, pod long, very deep green, well filled with peas of rich color and exquisite flavor. A heavy cropper. Pkt. 35c, lb. \$1.25, 2 lbs. \$2.00.

Parsley

DOBBIE'S EXHIBITION. This Parsley has long been recognized as a standard exhibition sort. It is remarkable for its large, fine leaves and close habits. The seed offered has been saved from selected plants only, every one of which was a perfect specimen. Pkt. 25c, oz. 75c.

Squash

DELICIOUS. One of the best varieties for table use. It is a fall and winter Squash, excellent at all seasons. Pkt. 10c, oz. 25c, ¼ lb. 75c.

GIANT STRAIGHTNECK SUMMER. A type nearly double the size of any other summer Squash. Despite its large size the flesh is rich and fine flavored. Pkt. 10c, oz. 25c, ¼ lb. 75c, lb. \$2.50.

HUBBARD, SYMMES BLUE. A superior strain, thick meated, fine grained, dry and very sweet. A heavy cropper and good keeper. Pkt. 10c, oz. 35c, ¼ lb. \$1.00.

THE WARREN. Resembles the Essex Hybrid, but has a shell generally harder and thicker. The color is of a richer and deeper orange. The flesh is of excellent quality. Pkt. 10c, oz. 35c, ¼ lb. \$1.00.

Spinach

NOBEL, GIANT-LEAVED. By far the best of the so-called smooth-leaved varieties. It grows rapidly and remains a long time in marketable condition. Oz. 15c, ¼ lb. 35c, lb. \$1.00.

SAVOY BLIGHT-RESISTING. On account of its resistance to blight, the yield is often very large. A valuable variety to use for fall sowing. Oz. 15c, ¼ lb. 35c.

Tomato

BREAK O' DAY. An early Tomato of the Marglobe type; fruit of good size, color scarlet, smooth and of good quality. Pkt. 10c, oz. 50c, ¼ lb. \$1.75.

COMET. One of the best for forcing; brilliant scarlet color; medium size, smooth and solid. Pkt. 10c, oz. 75c, ¼ lb. \$2.25.

LISTER'S EXCELSIOR. One of the best for forcing or outdoor culture; a heavy cropper of good flavor and color. Original pkts. 50c.

LISTER'S PROLIFIC. Clusters of fruit are borne in great profusion and are remarkable for the number they carry; smooth and of a rich scarlet color. Original pkts. 50c.

LISTER'S PROTECTION. The best of Lister's productions. Color dark crimson, a heavy cropper; perfect in shape and size. Pkt. 75c.

MARGLOBE. A midseason variety entirely immune from rust, pure scarlet, globe-shaped. Good size, heavy cropper and fine quality. Pkt. 10c, oz. 40c.

PENN STATE. An early variety, color rich scarlet, flesh dark red, quality and flavor of the finest. Pkt. 10c, oz. \$1.75, ¼ lb. \$6.00.

PRITCHARD. (Scarlet Topper). A midseason wilt resisting variety. Fruit large, globe-shaped, smooth; color, deep scarlet. Of excellent quality and fine flavor. Pkt. 10c, oz. 50c.

Before planting
Beans, inoculate
seed with

NITRAGIN

Important Free Delivery Notice

Free Delivery. When cash accompanies the order, we will send by Parcel Post to any part of the United States, east of the Mississippi River, all vegetable and flower seeds at quoted catalogue prices, on packages, ounces, quarter-pound, half-pound, pound and two pounds. For larger quantities, the purchaser pays transportation on bulk seeds, Bulbs, Field Seeds, Fertilizers, Grass Seeds, Onion Sets, Plants, Roots, Potatoes, Shrubs, Trees, Insecticides, Tools, and all Garden Requisites, except where free delivery is specified.

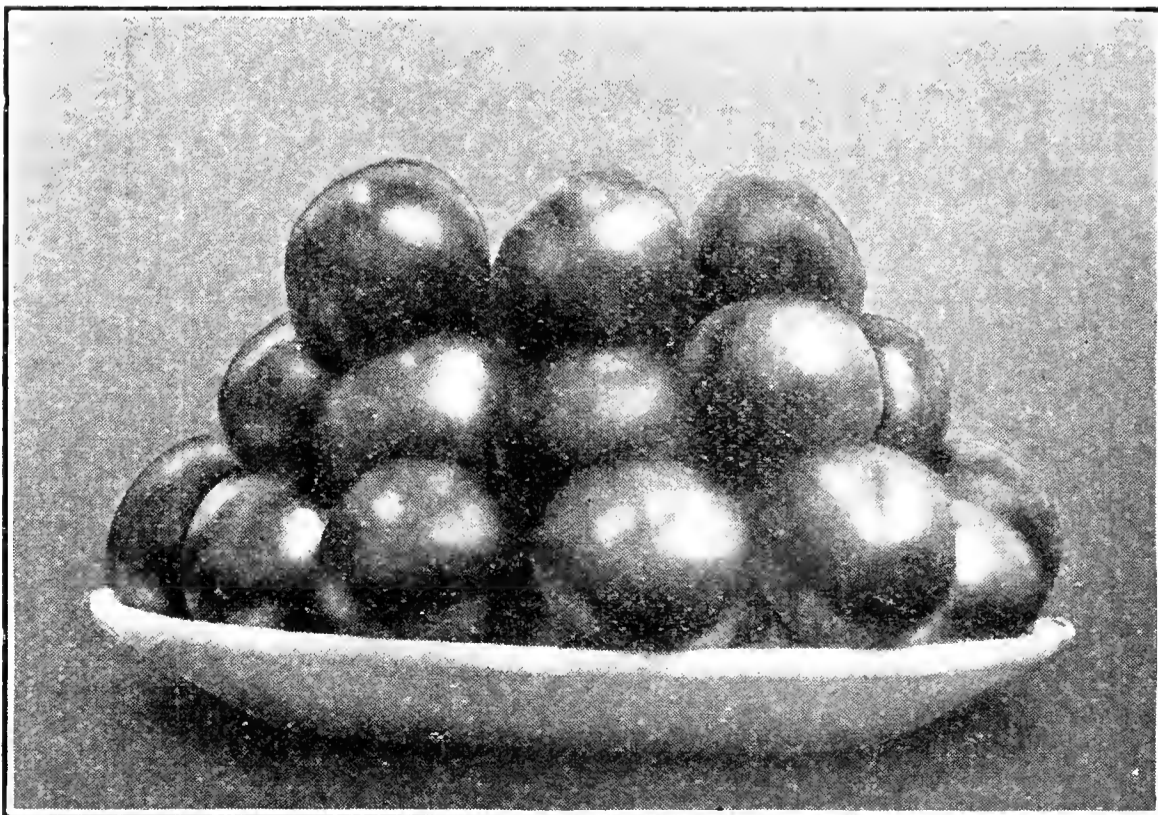

Bonny Best Tomato. (See page 60).

General List of VEGETABLE SEEDS

Our vegetable seeds are of the highest standard, grown for us by specialists. Our aim is purity, quality and service. Free Delivery. We will prepay Parcel Post charges on cash orders at quoted catalogue prices on Seeds, up to two pounds, anywhere in the United States, east of the Mississippi River; for larger quantities, the purchaser pays transportation charges.

Artichoke

Large Green Globe. The best variety; heads large and scales tender and excellent. Pkt. 25c, oz. \$1.00.

Jerusalem (*Helianthus tuberosus*). Cultivated for its edible tubers. April delivery only. Tubers, qt. 40c, pk. \$2.50.

Asparagus

One ounce will produce 200 plants.

The bed should be made rich by applying a heavy dressing of manure which should be plowed or spaded in; the roots should be set in rows 3 to 4 feet apart and 18 to 24 inches apart in the rows; the crown of the root should be 4 to 6 inches below the surface of the ground.

Mary Washington. The latest improved variety. Very large shoots, early, vigorous and quite rust-resistant. Pkt. 10c, oz. 50c, ¼ lb. \$1.50.

Martha Washington. Pkt. 10c, oz. 25c, ¼ lb. 75c.

ASPARAGUS ROOTS

Mary Washington. Select roots. \$2.25 per 100, \$20.00 per 1000.

Martha Washington. \$2.00 per 100, \$18.00 per 1000.

BEANS Dwarf or Bush

2 lbs. of Beans will sow 100 ft. drill. 75 lbs. to an acre.

Plant in rows 2 to 3 feet apart, dropping the beans 3 inches apart and covering 2 inches. Keep the ground free from weeds and cultivate often. All the varieties are tender and must not be planted until the soil is dry and warm.

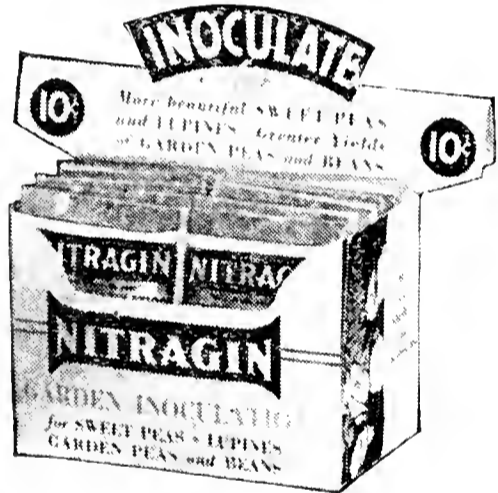

Before planting Beans, inoculate seed with

Free Delivery. We will prepay Parcel Post charges on cash orders at quoted catalogue prices on Beans, up to two pounds, anywhere in the United States, east of the Mississippi River; for larger quantities, the purchaser pays transportation charges.

We furnish 15c packets of all beans except where noted.

Wax-Podded Varieties

Black Wax, Improved Prolific. Early, very tender and of good quality. Lb. 35c, 2 lbs. 60c.

Black Wax Pencil. Pods are long, pencil-like, very tender and brittle. Lb. 35c, 2 lbs. 60c.

Brittle Wax. The best of the round podded sorts, maturing early, prolific, and bearing long, stringless pods of excellent quality. Lb. 35c, 2 lbs. 60c.

Davis' Kidney Wax. Plant vigorous and of compact, upright growth, with pods extra long, straight, oval. Lb. 35c, 2 lbs. 60c.

Golden Wax. The standard variety for general use; pods long, broad and flat, very fleshy and of fine quality. Vines erect, hardy and productive. Lb. 35c, 2 lbs. 60c.

Round Pod Kidney Wax. The pods are long, straight and extremely handsome. It is an exceedingly heavy bearer. Lb. 35c, 2 lbs. 60c.

Sure Crop Stringless Wax. A valuable new variety of dwarf wax Beans, very productive, rustproof, and will stand a longer season of damp, wet weather than any other wax Bean. Lb. 35c, 2 lbs. 60c.

Wardwell's Kidney Wax. Very long, straight, tender pods. Vines large, vigorous and productive. Lb. 35c, 2 lbs. 60c.

Webber Wax or "Cracker Jack." A high quality, flat-podded, stringless variety. Pods 6 to 6½ in. long, quite broad and uniformly curved, fleshy, stringless and brittle, with little fibre. Lb. 40c, 2 lbs. 75c.

Green-Podded Varieties

Abundance. An extra early variety, producing a heavy crop of long, stringless pods; excellent flavor. Lb. 40c, 2 lbs. 75c.

Asgrow Valentine. An extremely early entirely stringless Bean. Pods 6½ to 7 in. long and of excellent flavor. Lb. 35c, 2 lbs. 60c.

Bountiful. Extra early, very prolific and long bearing, flat green pods, tender and stringless. Lb. 35c, 2 lbs. 60c.

Broad Windsor (Sutton's White). English variety, very hardy. Lb. 50c, 2 lbs. 90c.

Emperor of Russia. Extremely prolific. Pods long, slender and meaty. Medium early. French grown. Lb. 50c, 2 lbs. 90c.

Giant Stringless Green Pod. Color deep green, very long, round, fleshy pods; very prolific and entirely stringless. Lb. 35c, 2 lbs. 60c.

Horticultural Dwarf. A shell bean of fine quality, early and productive. Lb. 35c, 2 lbs. 60c.

Horticultural French Dwarf. An improved form of Dwarf Horticultural, producing long pods, beautifully splashed with bright crimson, heavy cropper. Lb. 40c, 2 lbs. 75c.

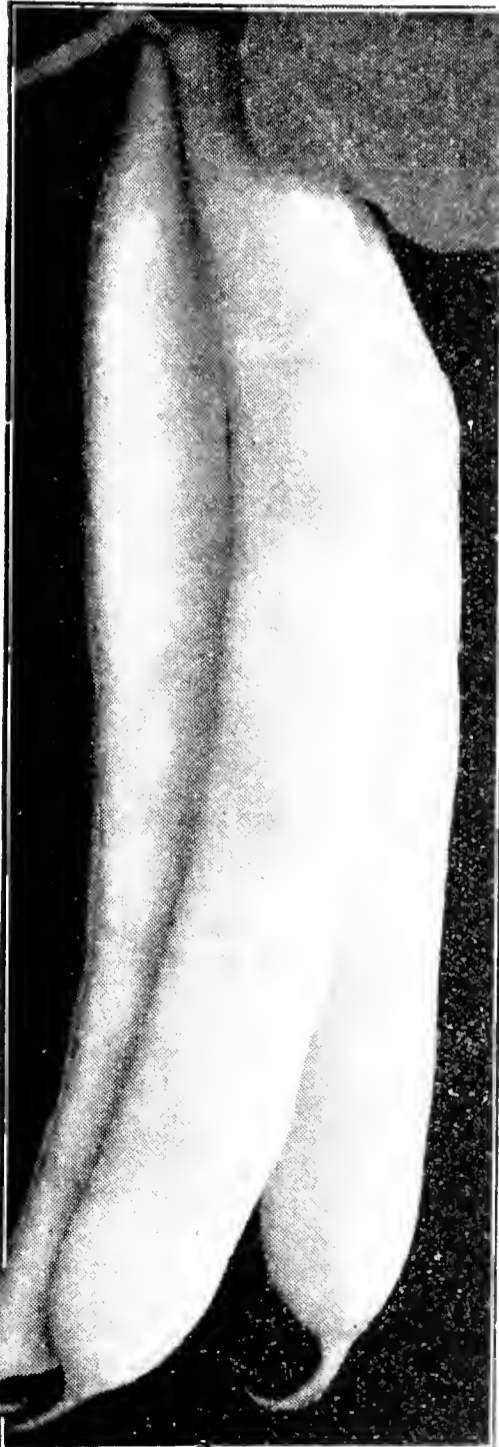

Webber Wax Beans

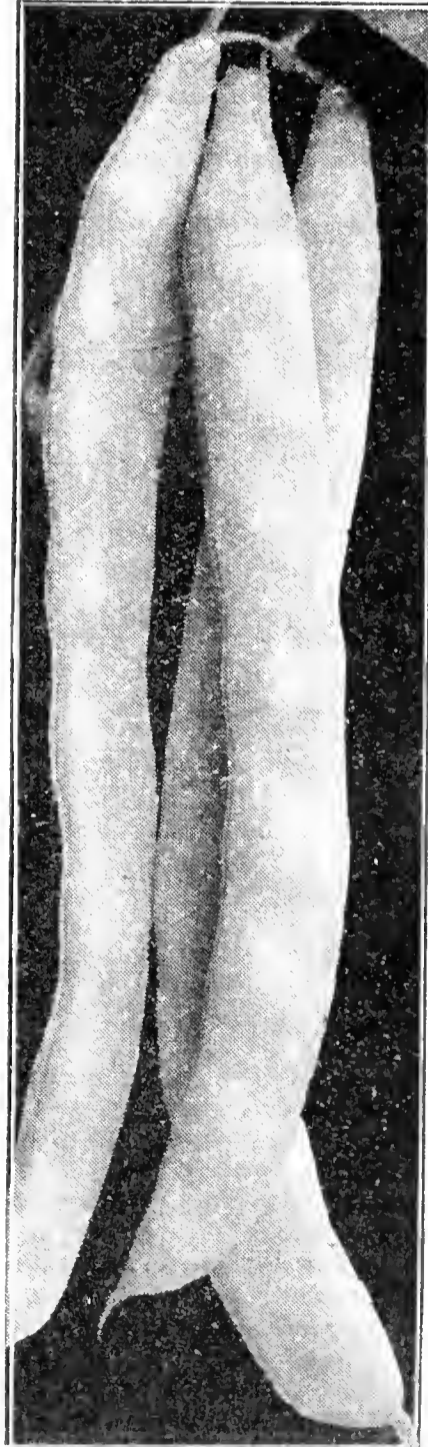

Bountiful Beans

BEANS, Green-podded Varieties—Continued

- Low's Champion.** One of the best for snap or shell, with stringless, large, green, flat pods. Lb. 30c, 2 lbs. 50c.
- Masterpiece Stringless Bush.** A fine variety for exhibition and for those who demand quality. Lb. 40c, 2 lbs. 75c.
- Plentiful, Sutton's.** One of the earliest varieties and one which we can confidently recommend. Lb. 40c, 2 lbs. 75c.
- Refugee, Late or 1000 to 1.** Very tender and productive; the best variety for pickling. Lb. 35c, 2 lbs. 60c.
- Stringless Green Pod, Burpee's.** Extra early, prolific, round pod and stringless. Lb. 30c, 2 lbs. 50c.
- Tendergreen.** An early, round podded variety, the pods are meaty, absolutely stringless, and of excellent flavor. Lb. 40c, 2 lbs. 75c.
- The Prince (Sutton's).** A first early variety producing a heavy crop of long, meaty pods, often measuring from 11 to 12 in. in length. Absolutely stringless and of excellent flavor. Pkt. 35c, lb. \$1.50, 2 lbs. \$2.50.
- Valentine Improved.** One of the earliest, pods round, thick and fleshy, of finest quality. Lb. 25c, 2 lbs. 45c.
- Wonder of France.** A valuable French variety for forcing. Lb. 50c, 2 lbs. 90c.

Dwarf or Bush Lima

Lima Beans are very susceptible to cold and wet, and apt to rot in the ground, and should not be planted until all danger from frost is over and the soil is dry and warm.

- Lima, Burpee's Improved Bush.** Best dwarf Lima Beans, large and delicious. Lb. 40c, 2 lbs. 75c.
- Lima, Dreer's Bush.** Possesses all the good qualities of the Dreer's Pole Lima. Lb. 40c, 2 lbs. 75c.
- Lima, Fordhook Bush.** Pods and beans twice the size of Dreer's Lima, and earlier. Lb. 40c, 2 lbs. 75c.
- Lima, Henderson's Bush.** Pods and beans small; of excellent quality as a shell Bean. Lb. 35c, 2 lbs. 60c.
- Lima, McCrear's Bush Lima.** A very early variety of excellent quality and flavor. The vines are strong and wilt resisting. We strongly recommend a trial of this splendid variety. Lb. 40c, 2 lbs. 75c.

Dwarf Shell Beans

- Improved Yellow Eye.** One of the best sorts for baking. Lb. 20c, 2 lbs. 35c, 8 lbs. \$1.25.
- Vermont Pea Bean.** A most productive small white baking variety, of superior quality. Lb. 20c; 2 lbs. 35c, 8 lbs. \$1.25.
- Red Kidney.** Popular baking Bean. Lb. 20c, 2 lbs. 35c, 8 lbs. \$1.25.

BEANS, Pole or Running

2 lbs. will plant 100 hills, 30 lbs. to the acre.

All under this head require poles 6 to 8 feet long and should not be planted until the ground is warm, as they are more tender than the dwarf varieties. Plant about the middle of May if the season is suitable.

- Burger's Stringless Green-Pod.** The pods, borne in clusters, average 6 to 8 inches in length. Lb. 35c, 2 lbs. 60c.
- Dutch Case-Knife.** Very early and prolific; fine shelled, green or dry. Lb. 35c, 2 lbs. 60c.
- Golden Cluster.** The earliest of the pole wax Beans and very productive. Quality excellent. Lb. 35c, 2 lbs. 60c.
- Improved Kentucky Wonder.** Excellent, very productive. Pods a silvery-green color of large size and entirely stringless. Lb. 30c, 2 lbs. 50c.
- Italian Pole.** A green-podded pole string Bean, absolutely stringless, unsurpassed for a string or shelled Bean. Pkt. 25c, lb. 75c, 2 lbs. \$1.35.
- Kentucky Wonder Wax.** A Wax Pole Bean with all the good qualities of old Kentucky Wonder. Lb. 35c, 2 lbs. 60c.



Pole Beans in Garden.

- King Horticultural.** Early and productive. A greatly improved Pole Horticultural. Lb. 30c, 2 lbs. 50c.
- Lazy Wife.** Pods long, stringless and of a rich buttery flavor. Lb. 35c, 2 lbs. 60c.
- Runner, Scarlet.** Bright scarlet flowers. Used both as a string and shelled Bean. Lb. 50c, 2 lbs. 90c.
- Runner, White.** Very effective planted with the Scarlet Runner. Lb. 50c, 2 lbs. 90c.

Pole Lima Beans

Lima Beans are very susceptible to cold and wet, and apt to rot in the ground, and should not be planted until all danger of frost is over, and the soil is dry and warm.

- Lima, Carpinteria.** A large-seeded variety of vigorous growth. Pods large and well filled with Beans of excellent flavor. Lb. 40c, 2 lbs. 75c.
- Lima, Dreer's Improved.** An improved Lima, being much thicker than the old Lima and superior in quality. Lb. 40c, 2 lbs. 75c.
- Lima, Early Leviathan.** A very early variety; produces pods in clusters. A splendid variety where the season is short. Lb. 40c, 2 lbs. 75c.
- Lima, Hopi.** Has the flavor of the large lima and can be used as a green bean or dry. The flavor is delicious. Lb. 40c, 2 lbs. 75c.
- Lima, King of the Garden.** Early and extremely prolific with large pods bearing five to six beans. Lb. 40c, 2 lbs. 75c.
- Lima, Siebert Early.** An immense yielder and excellent quality. Lb. 40c, 2 lbs. 75c.
- Lima, Sieva or Small.** A popular small-seeded variety. Lb. 35c, 2 lbs. 60c.

**CEDAR BEAN POLES, 8 to 10 ft. long, per doz. \$1.80,
per 100 \$14.00.**

Broccoli

One ounce will produce about 3500 plants.

The seed should be sown early in the spring and the plants transplanted into rows 3 feet apart, with 2 feet between the plants.

- Early Green Calabrese.** A distinct variety forming good sized green heads; this vegetable resembles the Cauliflower with combined Cauliflower and Asparagus flavor. Seed imported. Pkt. 25c, oz. \$1.50, ¼ lb. \$5.00.
- Rapa.** Produces numerous small green heads which are cut and bunched the same as sprouting Broccoli. Very early. Pkt., 10c, oz. 25c, ¼ lb. 75c.
- White Cape.** Heads compact, good size, and of a creamy white. Pkt. 10c, oz. 75c.

All prices subject to change without notice.

Beets

One ounce will sow 50 feet of drill: 5 to 6 lbs. an acre.

Sow in drills from April until July, 16 inches apart and about 1 inch deep; thin the plants about 3 inches apart. The Turniprooted are the best.

Crimson Globe. Early, of globe shape, and rich, deep crimson flesh. Pkt. 10c, oz. 20c, ¼ lb. 50c, lb. \$1.25.

Crosby's Egyptian Selected (Arlington Strain), One of the earliest dark-leaved varieties; fine quality. Pkt. 15c, oz. 50c, ¼ lb. \$1.50, lb. \$4.00.

Crosby's Egyptian. One of the earliest dark red varieties; fine quality. Very popular among market gardeners. Pkt. 10c, oz. 25c, ¼ lb. 75c.

Detroit Dark Red. Round and smooth, deep red, very tender. Pkt. 10c, oz. 25c, ¼ lb. 75c.

Dewing's Blood Turnip. Of fine form and flavor; deep red. A desirable variety. Pkt. 10c, oz. 20c, ¼ lb. 50c; lb. \$1.25

Early Wonder. The most perfect model of an extra early round Beet. The flesh is deep blood-red crimson. It is an ideal all season Beet. Pkt. 10c, oz. 25c, ¼ lb. 75c, lb. \$2.00.

Edmand's. Deep blood-red color, round and smooth, excellent quality; highly recommended. Pkt. 10c, oz. 20c, ¼ lb. 50c, lb. \$1.25.

Grey's Blood Turnip. One of the very best strains for market gardeners; small top, round, handsome and very dark red. Pkt. 15c, oz. 50c, ¼ lb. \$1.50, lb. \$4.00.

Perpetual, or Spinach Beet. This variety will give a constant supply of Spinach throughout the season. Pkt. 10c, oz. 20c, ¼ lb. 50c.

Swiss Chard. The leaves are used as Spinach, and the midrib of the leaf, cooked and served up like Asparagus, is delicious. Pkt. 10c, oz. 20c, ¼ lb. 50c.

Swiss Chard, Fordhook Giant. A superior variety of Chard with dark green, crumpled leaves. Pkt. 10c, oz. 25c, ¼ lb. 75c.

Swiss Chard, Lucullus. A tall-growing variety, crinkled leaves, tender and of fine flavor. Pkt. 10c, oz. 20c, ¼ lb. 50c.

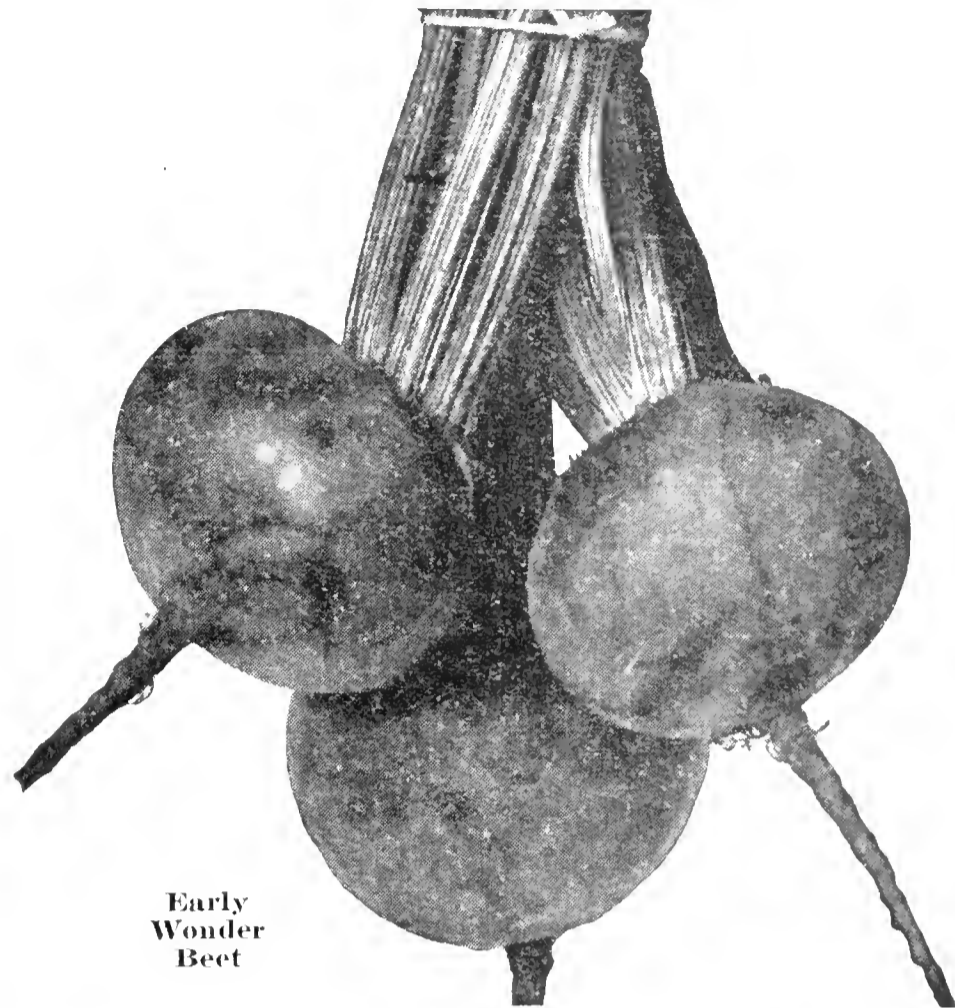

Early Wonder Beet

Sugar Beet and Mangel Wurzel

Sow in April or May, using 6 to 8 lbs. of seed to the acre.

Danish Sludstrup. Very high yielder. Roots long, oval, orange colored; flesh white with faint yellow tinge. Oz. 10c, ¼ lb. 25c, lb. 75c.

Grey's Prize Long Red Mangel Wurzel. The most largely grown of the Mangels; roots attain an enormous size, producing 30 to 50 tons to the acre; quality superior, the best for deep soil. Oz. 20c, ¼ lb. 60c, lb. \$1.50.

Golden Tankard Mangel Wurzel. The flesh is bright golden yellow; very large, and will produce more Mangels to the acre than any other variety; excellent for feeding stock. Oz. 10c, ¼ lb. 25c, lb. 75c.

Giant Yellow Intermediate Mangel Wurzel. A very large yellow sort, of good quality, and produced in great abundance. Oz. 10c, ¼ lb. 25c, lb. 75c.

Lane's Improved Sugar Beet. Large, hardy, productive and excellent quality. Oz. 10c, ¼ lb. 25c, lb. 75c.

Norbiton Giant Mangel Wurzel. Long red. A valuable variety for deep soil; very productive. Oz. 10c, ¼ lb. 25c, lb. 75c.

Red Globe. Similar to Yellow Globe except in color. Oz. 10c, ¼ lb. 25c, lb. 75c.

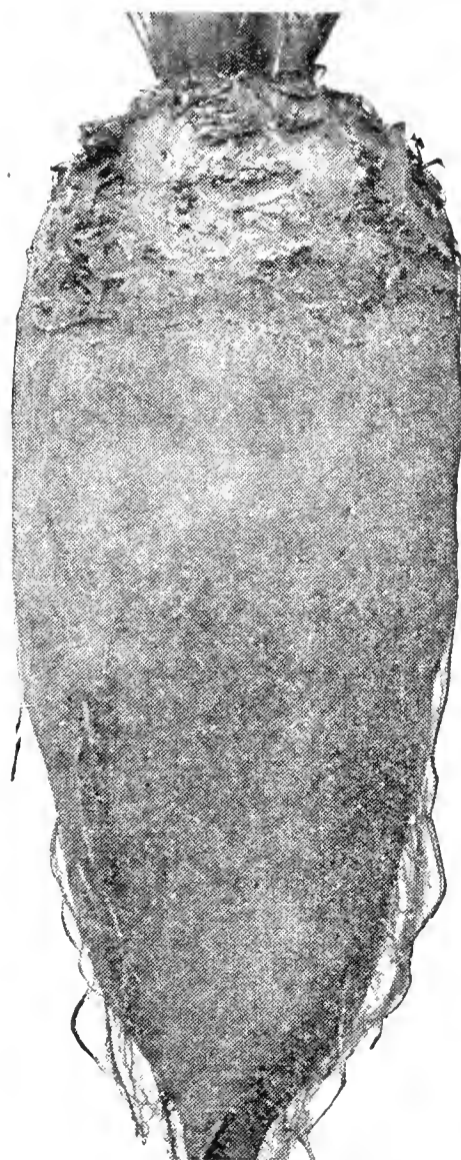

Grey's Prize Long Red Mangel Wurzel

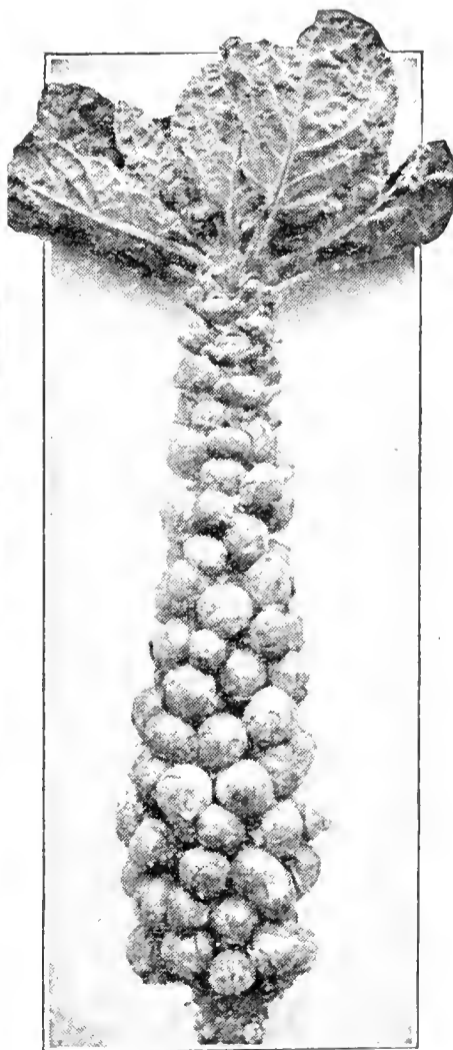

Brussels Sprouts

Brussels Sprouts

One ounce will produce 2000 plants.

Cultivated for the small heads that grow from the main stem; these small heads are firm and compact, like little Cabbages, and are considered a great delicacy by many people. Cultivate the same as Cabbage or Cauliflower.

Dobbie's Exhibition. Grows tall; is of good quality and very productive. Pkt. 25c, oz. \$1.25.

Improved Dwarf French. Tender and of fine flavor. Pkt. 10c, oz. 50c.

Long Island Improved. Very compact heads, productive. Pkt. 25c, oz. \$1.25.

NOTICE. We are pleased at all times to quote prices on special grass mixtures, and for those wishing mixtures of their own formula, we will either ship the varieties separate, or mix them to the customer's instruction. See Pages 63-64-65.

Cabbage

One ounce produces about 3000 plants.

For early use a sowing may be made in the hotbed in February or March, and for winter use seed should be sown in the open ground in May or June. When the plants are 5 or 6 inches in height, transplant into rows 3 to 3½ feet apart, setting the plants from 2 to 3 feet apart in the rows, according to the variety.

American Improved Savoy. The favorite curled Savoy Cabbage of finest quality, and an excellent keeper. Pkt. 10c, oz. 35c, ¼ lb. \$1.25.

Autumn King. The heads are of enormous size and very solid. Pkt. 10c, oz. 35c, ¼ lb. \$1.25.

Baby Head Cabbage. The heads are small and of fine quality. We recommend Baby Head Cabbage for greenhouse growing and where space is limited. The seed we offer is grown for us in Denmark. Pkt. 15c, oz. 75c.

Charleston, or Large Wakefield. This strain is about one week later than early Jersey Wakefield. Pkt. 10c, oz. 35c, ¼ lb. \$1.25.

Copenhagen Market. As early as Charleston Wakefield. Very solid. Excellent market sort. Pkt. 10c, oz. 40c, ¼ lb. \$1.25.

Danish Ballhead. A winter Cabbage. Extra hard-headed, of fine quality. Pkt. 10c, oz. 40c, ¼ lb. \$1.25.

Danish Roundhead. A short-stemmed type of the Danish Ballhead, maturing earlier than that variety; excellent quality, large, solid, globe-shaped heads. One of the best winter sorts. Pkt. 10c, oz. 40c, ¼ lb. \$1.25.

Early Summer, Henderson's. A few days later than Wakefield, rather larger and more globe-shaped. Pkt. 10c, oz. 35c, ¼ lb. \$1.25.

Early Jersey Wakefield. One of the most popular early pointed varieties; good grower. Pkt. 10c, oz. 35c, ¼ lb. \$1.25.

Early Wonder Red. The earliest of all red Cabbages. The heads are large, solid and handsome, of delicious flavor, color dark red. Pkt. 10c, oz. 60c.

Fotter's Brunswick. The standard market variety; a drumhead; grows to a large size; solid, tender, good shape and a good keeper. Pkt. 10c, oz. 35c, ¼ lb. \$1.25.

Globe Curled Savoy. A variety with finely curled leaves and of delicate flavor; used for fall crop or for winter. Pkt. 10c, oz. 50c, ¼ lb. \$1.50.

Glory of Enkhuizen. A second early globe-shaped, sure heading variety; the heads are large, often weighing 8 to 10 lbs. each and very solid. Pkt. 10c, oz. 40c, ¼ lb. \$1.25.



Copenhagen Market Cabbage

Golden Acre. A new Cabbage, head measuring 9 in. in diameter; 10 days earlier than Copenhagen Market and more compact. Pkt. 10c, oz. 40c, ¼ lb. \$1.25.

Mammoth Red Rock. The largest and surest heading Red Cabbage; heads as large and solid as Flat Dutch and fine grained. Pkt. 10c, oz. 35c, ¼ lb. \$1.25.

Penn State Ballhead. A large somewhat flattened form of the Ballhead, producing probably the largest tonnage per acre of any known variety. This is one of the best winter varieties. Pkt. 15c, oz. 75c, ¼ lb. \$2.50.

Red Dutch Pickling. Used extensively for pickling; tender, medium size. Pkt. 10c, oz. 35c, ¼ lb. \$1.25.

Stone Mason. Select strain. One of the oldest and best known varieties; large size; drumhead; grown principally as a late Cabbage, and for winter keeping. Pkt. 10c, oz. 50c, ¼ lb. \$1.50.

Cabbage Plants. See page 62.

Chinese or Celery Cabbage

This is a native of China and distinct from other cabbage; it grows like Romaine lettuce and makes an elegant salad, with a delightful flavor. Seed should be sown the latter part of July, in rows 2½ feet apart and the plants thinned out to 18 to 20 inches in the rows; if sown too early the heat causes it to run to seed.

Chilli. For fine quality, earliness and sure heading, this variety is unsurpassed. Heads grow 18 to 20 inches tall, 3½ to 4 inches thick, tapered near tip. Very firm, well blanched, crisp, tender and sweet. Pkt. 10c, oz. 50c, ¼ lb. \$1.50.

Pe Tsai. This resembles in appearance and growth a head of Romaine lettuce; heads are firm; grows somewhat taller than Wong Bok, but not as thick through. Pkt. 10c, oz. 50c, ¼ lb. \$1.50.

Wong Bok. Does not grow quite as tall as Pe Tsai, but is thicker through; heads are elongated, self-folding and require no blanching. Pkt. 10c, oz. 50c, ¼ lb. \$1.50.

Cabbage Plants. See page 62.



Globe Curled Savoy Cabbage

Carrot

One ounce will sow 100 feet of drill, 3 lbs. required for one acre.

The Carrot flourishes best in a good, light, well enriched loam. The early, small-sized varieties may be sown in drills 10 inches apart, but the larger sorts require at least 18 inches between the rows; cover about ½ inch deep, and when the plants are well up, thin to 3 to 4 inches apart. As an agricultural root, the Carrot is unsurpassed for feeding stock.

We furnish packets of all varieties of Carrots at 10c each, postpaid, except where noted.

Amsterdam Forcing (Coreless). the roots are a bright salmon-red color, blunt ended and small tap-root, the flesh is crisp, sweet, and extremely fine grained. Pkt. 10c, oz. 25c, ¼ lb. 75c.

Chantenay, Morse's Red Cored. Excellent medium early, half long, stump rooted variety. An excellent table Carrot. Pkt. 10c, oz. 25c, ¼ lb. 75c.

Danvers Half-Long. The best variety for general crop; is of rich color and a good keeper. Pkt. 10c, oz. 25c, ¼ lb. 75c.

Danvers Half-long Improved, Special Strain. Grown for us by a leading Carrot specialist. Pkt. 15c, oz. 50c, ¼ lb. \$1.50.

Earliest French Forcing. The earliest variety and good for forcing under glass. Pkt. 10c, oz. 25c, ¼ lb. 75c.

Early Scarlet Horn. A medium sized root, half long, of fine color. Pkt. 10c, oz. 25c, ¼ lb. 75c.

Guerande or Oxheart. Intermediate length, 3 to 5 in. in diameter; fine quality. Pkt. 10c, oz. 20c, ¼ lb. 60c, lb. \$1.50.

Hutchinson Strain. A very fine Carrot, 8 to 9 in. long, nearly the same size the whole length and stump-rooted. Color deep orange and of fine quality. Pkt. 10c, oz. 50c, ¼ lb. \$1.50.

Half-long Scarlet Nantes. A stump-rooted variety of fine color. Pkt. 10c, oz. 25c, ¼ lb. 75c.

Imperator. An outstanding variety, the roots average about 8 inches long, the flesh is of a rich orange color, fine grained, tender, and of fine quality. Pkt. 10c, oz. 25c, ¼ lb. 75c, lb. \$2.25.

Improved Long Orange. Excellent for stock or table use; roots deep orange. 12 to 15 in. Pkt. 10c, oz. 20c, ¼ lb. 60c, lb. \$1.50.

James' Intermediate. The best intermediate variety tapering to a point; small core and of fine flavor. Pkt. 10c, oz. 25c, ¼ lb. 75c.

Pride of Denmark. A wonderfully fine Carrot 8 to 9 inches long and 2 to 3 inches in diameter, being practically the same size the whole length. It closely resembles the Hutchinson, but has less core and deeper color. Pkt. 15c, oz. 50c, ¼ lb. \$1.50.

Cauliflower

One ounce will produce 3000 plants.

The Cauliflower, like the Cabbage, requires a deep, rich soil. Sow the seed in the hotbed in March and transplant into the garden in May; set the plants in rows and cultivate the same as Cabbage.

Danish Perfection. A very early variety of the Dwarf Erfurt type. All the heads mature at the same time, making it possible to clear the ground at one cutting. Pkt. 25c, oz. \$5.00.

Early Snowball. Grey's Selected. This strain has given excellent satisfaction during the many years we have sold it, and we believe no better strain can be found. Pkt. 25c, oz. \$5.00, ¼ lb. \$14.00.

Earliest Dwarf Erfurt. One of the earliest varieties; very dwarf, with large, white, compact heads of finest quality. Excellent for forcing. Pkt. 25c, oz. \$5.00, ¼ lb. \$14.00.

Early Dwarf Danish, or Dry Weather. A choice strain that comes to maturity very evenly; a favorite for first crop with many growers. Pkt. 25c, oz. \$5.00, ¼ lb. \$14.00.

Veitch's Autumn Giant. Heads very large, white and compact; well protected by foliage; will remain suitable for use a long time. Pkt. 10c, oz. \$1.00, ¼ lb. \$2.50.

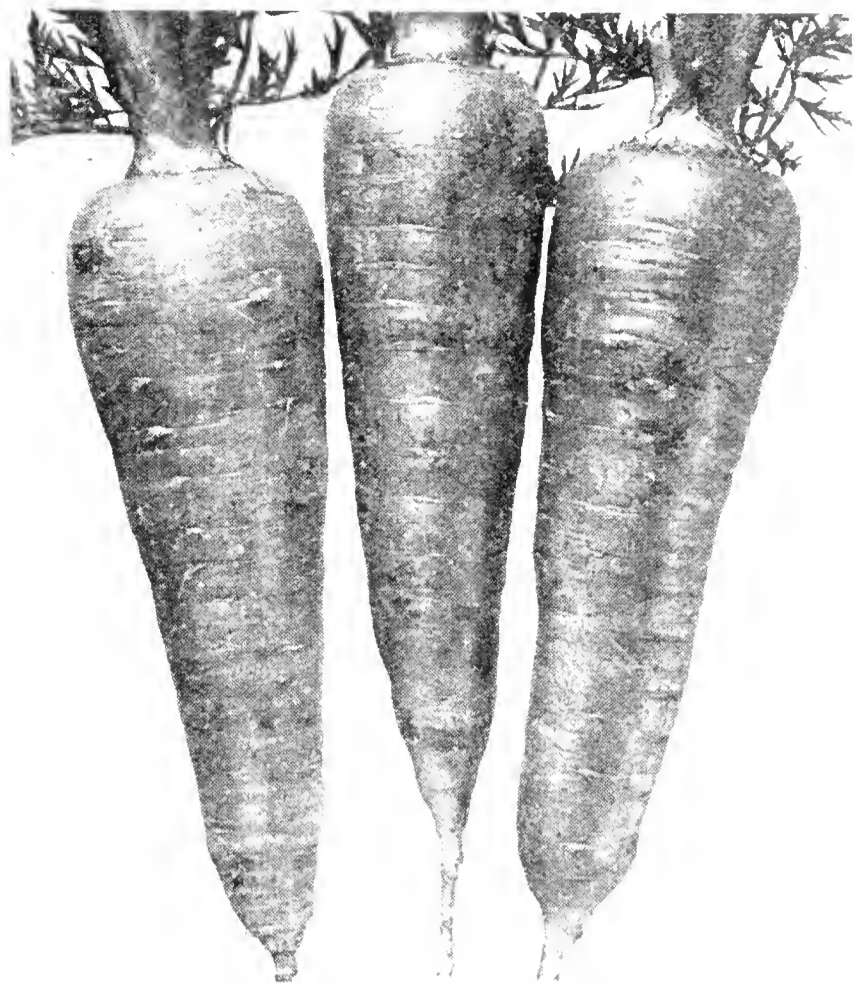

Danvers Half-Long Improved Special Strain Carrots
Cardoon

Large Smooth. A tender and richly flavored variety which blanches easily. Pkt. 10c, oz. 50c, ¼ lb. \$1.50.

Chervil

Curled Chervil. Cultivated like Parsley. The young leaves are used for flavoring soups and salads and are also used for garnishing. Pkt. 10c, oz. 25c, ¼ lb. 75c.

See Endive, page 50.

Chicory

Large-rooted Magdeburg. Roots when dried and roasted are used as a substitute for coffee. Pkt. 10c, oz. 25c, ¼ lb. 75c.

Witloof, or French Endive. This grows in a solid oblong head and blanches ivory white. One of the choicest of all winter salads. Pkt. 10c, oz. 40c, ¼ lb. \$1.25.

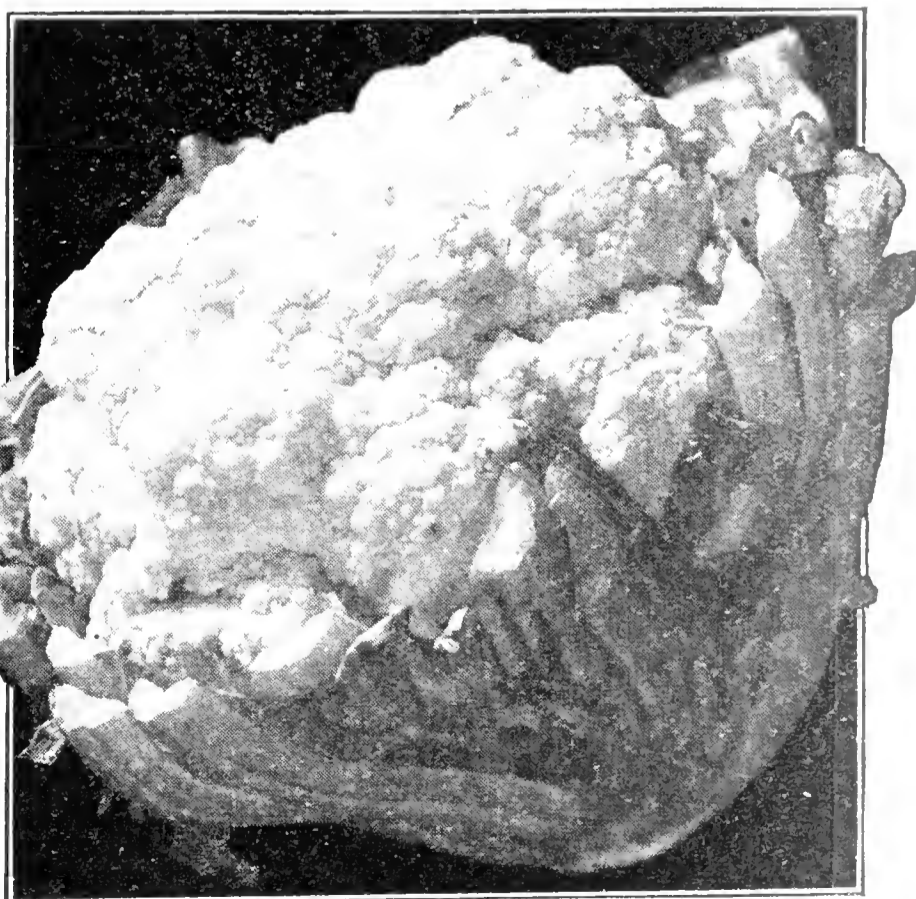

Grey's Selected Early Snowball Cauliflower

Celery

One ounce will produce about 4000 plants.

Sow the seeds in March or April in a hotbed or cold-frame. As soon as the plants are 3 inches high, transplant into a prepared border, setting them 4 inches apart. When grown 6 inches, and fine stocky plants, set in richly manured deep soil, in rows 3½ feet apart and about 9 inches from plant to plant.

Boston Market. (Selected Strain.) The finest flavored variety in cultivation; solid, crisp and of excellent nutty flavor; dwarf, branching habit; blanches perfectly white; a splendid keeper. Pkt. 25c, oz. \$1.00.

Carter's Dwarf Crimson. Crisp, tender and delicious; a good keeper. Pkt. 25c, oz. \$1.50.

Celeriac or Turnip-rooted Celery, Giant Smooth Prague. Turnip-shaped roots; cultivated as Celery. Pkt. 10c, oz. 50c, ¼ lb. \$1.50.

Easy Blanching. The plants make a rapid and vigorous growth, producing rather thick, solid stalks of excellent quality and rich, nutty flavor. Pkt. 15c, oz. \$1.50.

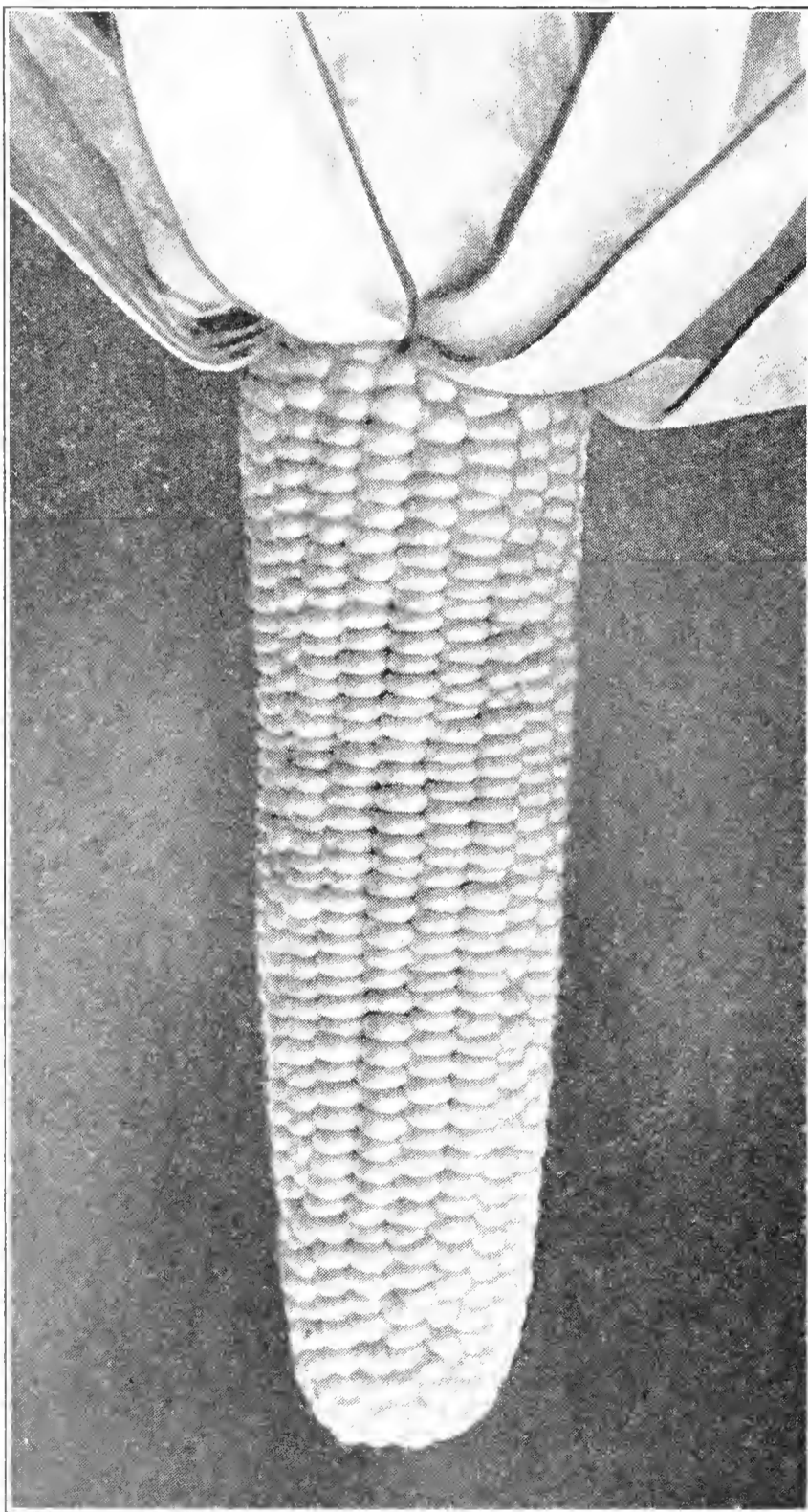

Stowell's Evergreen, Platt's Strain

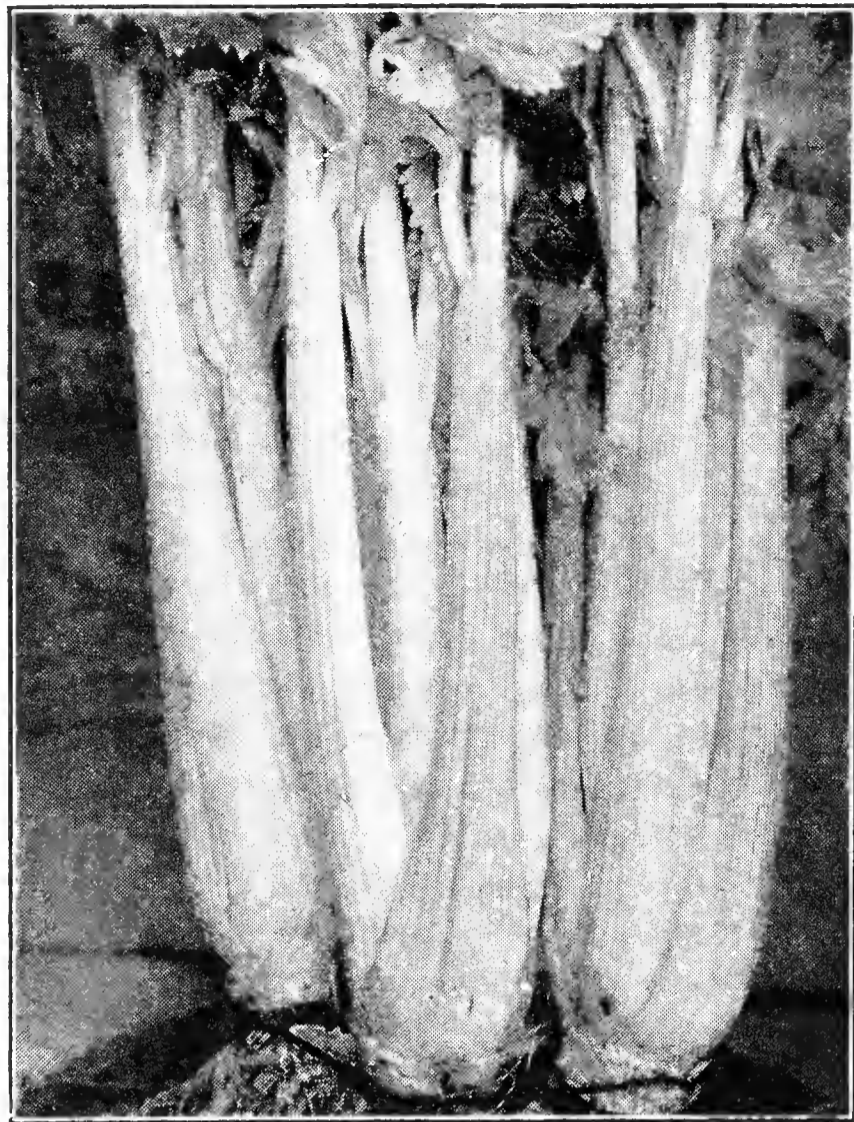

Golden Self-Blanching Celery

Giant Pascal (Arlington Strain). A valuable variety for both second early and winter use. Pkt. 10c, oz. 50c, ¼ lb. \$1.75.

Golden Plume. The plants are of strong growth and produce thick and heavy stalks of excellent crisp and nutty flavor. Pkt. 10c, oz. \$1.00, ¼ lb. \$3.50.

Newark Market. Green, easy blanching variety; stalks large, solid, crisp and tender; a good keeper and will blanch in cold storage. Pkt. 15c, oz. \$1.50.

Paris Golden. The plant blanches quickly to a beautiful golden yellow; the stalks are brittle and have a fine, nutty flavor. Pkt. 10c, oz. \$1.00, ¼ lb. \$3.00.

White Plume. Ornamental; stalks and portions of leaves are naturally white. Pkt. 10c, oz. 50c, ¼ lb. \$1.75.

Winter Queen. This is one of the finest dwarf winter Celeries. Pkt. 10c, oz. 50c.

CORN, Sweet or Sugar

One pound of corn will plant 100 feet of drill or 150 hills; 12 lbs. to the acre.

We furnish 15c packages of all varieties of Sweet Corn except where noted.

Free Delivery. We will prepay Parcel Post charges on cash orders at quoted catalogue prices on Corn, up to two pounds, anywhere in the United States, east of the Mississippi River; for larger quantities, the purchaser pays transportation charges.

Plant in hills 3 feet apart each way, dropping five or six kernels in each hill, or plant in rows 3 to 4 feet apart, and thin the plants out to 8 or 9 inches in row.

Bantam Evergreen Corn. A yellow variety maturing about 10 days after the Golden Bantam and a week earlier than the Stowell's Evergreen white. It has an ear three times the size of Golden Bantam. Lb. 30c, 2 lbs. 50c, 12 lbs. \$2.50.

Black Mexican. A medium early variety, very sweet, tender, and of delicious flavor. Lb. 30c, 2 lbs. 50c.

Sweet Corn—Continued

Country Gentleman. Cob small, with deep kernels of pearly whiteness; quality delicious. Lb. 30c, 2 lbs. 50c, 12 lbs. \$2.50.

Early Crosby. A popular variety; early, good size and quick growth; white kernels and one of the best. Lb. 30c, 2 lbs. 50c, 12 lbs. \$2.50.

Early Golden Improved. Sweet, tender and delicious. Ears large, 10- to 12-rowed, rich golden yellow color. New England grown. Lb. 30c, 2 lbs. 50c, 12 lbs. \$2.50.

Golden Bantam. Early, sweet and tender. Smaller than Early Golden; 8-rowed. A favorite variety. Lb. 30c, 2 lbs. 50c, 12 lbs. \$2.50.

Golden Cross Bantam. Ears 7 to 8 inches long, 10 to 14-rowed. Slightly lighter yellow than Golden Bantam. Sweet and of fine flavor. Pkt. 25c, lb. 60c, 2 lbs. \$1.00.

Golden Giant. With its 12- to 16-rowed ears and deep golden yellow kernels it is the most desirable yellow sweet Corn yet introduced. Lb. 35c, 2 lbs. 60c, 12 lbs. \$3.00.

Golden Sunshine. The earliest of the Golden Bantam type, Ears 6½ inches long, containing 12 rows of broad, yellow, sweet grains. Lb. 30c, 2 lbs. 50c, 12 lbs. \$2.50.

Grey's Miniature White Corn. Grows about 30 inches high; ears 3 to 4 inches long, of fine quality and very sweet. Supply limited. Pkt. 35c, ¼ lb. 60c, lb. \$2.00.

Mayflower, Early. Matures one week in advance of White Cory. Growth of stalk 4½ to 5 ft., 8 to 12 rows of kernels; large ear. Lb. 30c, 2 lbs. 50c, 12 lbs. \$2.50.

Peep o' Day. This Corn has two valuable points—extraordinary earliness and sweetness. Lb. 30c, 2 lbs. 50c, 12 lbs. \$2.50.

Pocahontas. One of the earliest varieties in cultivation; ears large and very productive; of fine quality. Lb. 30c, 2 lbs. 50c, 12 lbs. \$2.50.

Potter's Excelsior or Squantum. Medium late, 12-rowed ears of excellent quality. Lb. 30c, 2 lbs. 50c, 12 lbs. \$2.50.

Spanish Gold. Grows from 5 to 6 ft. high. Ripens early and has much of the tenderness and flavor of Golden Bantam. Lb. 30c, 2 lbs. 50c, 12 lbs. \$2.50.

Stowell's Evergreen, Special Strain. This Corn specially adapted for New England. The kernels are long and narrow, 18- to 22-rowed. Lb. 25c, 2 lbs. 40c, 12 lbs. \$2.25.

Tendergold. A hybrid wilt resisting sweet corn. The ears average 8 inches in length and are 12 rowed. Quality of the finest, very tender and sweet. Pkt. 25c, lb. 60c, 2 lbs. \$1.00.

Whipple's Yellow Sweet Corn. The ears are very large, 8 to 9 inches long, having 14 to 18 rows of deep kernels. Lb. 30c, 2 lbs. 50c, 12 lbs. \$2.50.

Corn, Field and Fodder. See page 66.

Cucumber

One ounce will plant about 50 hills, 2 to 3 pounds an acre.

For very early use seed may be started in heat and the plants set out in May. For main crop, plant in hills 4 feet apart, in the end of May. Make the hills rich with well rotted manure. Leave four strong plants to each hill.

Arlington White Spine. One of the most perfect in shape, size, color and quality, and is very brittle and crisp. Pkt. 10c, oz. 25c, ¼ lb. 75c.

Boston Pickling. The best pickling variety yet introduced; very productive. Pkt. 10c, oz. 25c, ¼ lb. 75c.

Davis Perfect. Highly recommended; dark, rich green in color, crisp and tender. Pkt. 10c, oz. 25c, ¼ lb. 75c.

Fordhook Famous. Fruit long, thick, and tapering at both ends, crisp and solid; a fine slicing sort; color light green. Pkt. 10c, oz. 25c, ¼ lb. 75c.

Grey's A-1. The fruits will average 12 to 14 inches in length by 2½ inches in diameter and are very symmetrical; the color a very dark green. Pkt. 25c, oz. \$1.00.

Improved White Spine. The best variety for table use or for market. Pkt. 10c, oz. 25c, ¼ lb. 75c.

Japanese Climbing. Fruit about 10 inches long; thick and of fine flavor. Skin dark green, flesh pure white; can be grown on trellises and fences. Pkt. 10c, oz. 25c, ¼ lb. 75c.

Longfellow. One of the finest quality cucumbers for growing in the open ground. The fruit is 10 to 12 inches long, 2½ inches in diameter and of the highest quality. Pkt. 10c, oz. 50c.

Long Green. Prickly; firm, crisp, dark green; excellent table variety. Pkt. 10c, oz. 25c, ¼ lb. 75c.

Straight-8. This outstanding variety produces dark green fruit, 8 to 9 inches long and 1½ inches in diameter. Flesh white, crisp, and of the finest quality. Pkt. 10c, oz. 50c.

West India Gherkin. Used for pickling purposes; a small, oval-shape variety; has the appearance of a bur. Pkt. 10c, oz. 25c, ¼ lb. 75c.

Woodruff's Hybrid. One of the best of the White Spines for market. Grows 8 to 10 inches long and stays green a long time. Pkt. 10c, oz. 25c, ¼ lb. 75c.

ENGLISH FRAME VARIETIES

The following are excellent varieties for growing in forcing houses.

Delicacy (Sutton's). Fruits dark green, slightly ribbed, ideal form and fine flavor. Pkt. 50c.

Every-day (Sutton's). Fruits of good length, color deep green, almost smooth. Pkt. 50c.

King George (Sutton's). Fruits are unusually handsome and perfect in form. Pkt. 50c.

Matchless (Sutton's). Fruits smooth, dark in color and of the highest quality. Pkt. 50c.

Rochford's Market. A well-known variety; heavy cropper. Pkt. 50c.

Satisfaction (Sutton's). Fruit large, straight, dark green, flavor excellent. Pkt. 50c.

Telegraph Improved (Sutton's). Fruit handsome with very small neck; very prolific. Pkt. 50c.

Tender and True. A well known variety, heavy cropper. Pkt. 50c.

SEMESAN. Place a little Semesan with seeds in a jar and shake vigorously; bacteria and fungus spores adhering to seeds will be killed. 2 ozs. 35c, lb. \$2.25, 5 lbs. \$9.90.

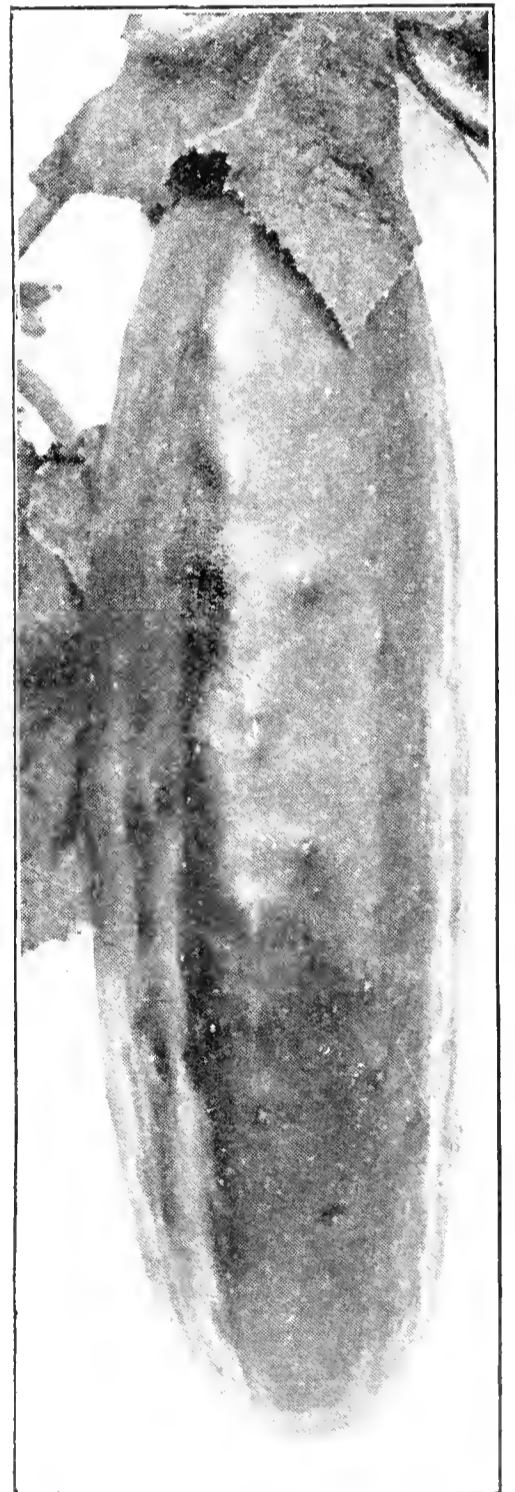

Arlington White Spine
Cucumber

Chives

Seed. Pkt. 25c, oz. 75c.

Roots. 30c per clump, 12 clumps \$3.00. By mail, add 10c extra for each clump.

Collards

Georgia, Southern, or Creole. This vegetable develops a loose-leaved head. It grows 2 or 3 feet high and produces large, light green leaves on rather long stems. A frost, if not too severe, will improve the crop. Pkt. 10c, oz. 20c, $\frac{1}{4}$ lb. 60c, lb. \$1.50.

Corn Salad or Fetticus

One ounce will sow 100 feet of drill.

This excellent salad may be had the year round. Sow in September, in drills 8 inches apart, covering the seeds lightly to protect from frost by a light covering of hay or litter. The seed may also be sown in spring.

Large-seeded. The most popular variety grown. Pkt. 10c, oz. 25c, $\frac{1}{4}$ lb. 75c.

Cress or Pepper Grass

One ounce will sow 100 feet of drill.

A popular salad, which should be sown early in spring—very thickly in shallow drills—and at short intervals, for succession, as it soon runs to seed.

Extra Curled. The best variety grown; leaves are beautifully cut and curled; highly prized for garnishing. Pkt. 10c, oz. 20c, $\frac{1}{4}$ lb. 40c, lb. \$1.25.

Water. This wholesome salad may be grown in any moist situation. Plants should be set not less than a foot apart. The Cress is fit for gathering the second year. Pkt. 10c, oz. 75c, $\frac{1}{4}$ lb. \$2.25, lb. \$7.00.

Kohlrabi

One ounce will sow 200 feet of drill.

The seed may be sown in June in rows 18 inches apart, and the plants thinned out to 8 or 10 inches.

Purple Vienna. Similar to the following, except in color. Pkt. 10c, oz. 35c, $\frac{1}{4}$ lb. \$1.25.

White Vienna. The earliest and best table or market variety. Pkt. 10c, oz. 35c, $\frac{1}{4}$ lb. \$1.25.



Black Beauty Eggplant

Dandelion

One ounce will sow 200 feet of drill: 2 lbs. will sow an acre

Sow seed in May or June, in drills $\frac{1}{2}$ inch deep and 15 inches apart. Thin the plants to stand 4 inches apart, cultivate during the summer to keep down weeds. Dandelion may be blanched like Endive for salad purposes, or it may be sown later in the season. Plant—cover lightly with salt hay, and the following spring they will be fit for use as early greens, and considered one of the earliest and most healthful spring greens or salads.

American Improved. The finest variety, leaves very numerous, thick in texture and blanch rapidly. Pkt. 25c, oz. \$1.00, $\frac{1}{4}$ lb. \$3.00.

French Thick Leaf. Unsurpassed in thickness of leaf and deep green color. Pkt. 10c, oz. 50c, $\frac{1}{4}$ lb. \$1.50.

Eggplant

One ounce will produce about 1500 plants.

Sow in hotbeds very early in spring, and transplant when two inches high into a second bed or into small pots. If that is not done, thin to 4 inches apart. Do not plant out till the weather becomes perfectly settled and warm. Keep plants watered for a few days if the sun is hot when put out. Set out plants 3 feet by 2.

Black Beauty. Very early and as large as New York Improved. Rich purplish black color. Pkt. 10c, oz. 50c.

Black Pekin. Fruit globular, almost black in color, fine grained and delicately flavored. Pkt. 10c, oz. 50c.

Early Long Purple. A very early, hardy and productive variety of good quality. Pkt. 10c, oz. 50c.

New York Improved. A leading market variety; fruit large, oval, very productive. Pkt. 10c, oz. 50c.

Endive

One ounce will sow 200 feet of drill.

A rather moist soil is preferred. Sow early in the spring in drills, 12 inches apart, and thin out the plants to 10 inches apart in the drills as soon as they are large enough to handle.

Broad-leaved Batavian. Leaves broad; light green, and require to be tied up for blanching. Pkt. 10c, oz. 35c, $\frac{1}{4}$ lb. \$1.00.

Green Curled. A very hardy dark green, closely curled variety, tender and crisp. Pkt. 10c, oz. 35c, $\frac{1}{4}$ lb. \$1.00.

Moss Curled. Beautifully curled, and when well developed resembles a tuft of moss. Pkt. 10c, oz. 35c, $\frac{1}{4}$ lb. \$1.00.

Witloof. See Chicory, page 47.

Fennel, Florence or Naples

(Finocchio di Napoli)

Sow in spring in rows 16 to 20 inches apart and thin to 5 or 6 inches apart. Water freely. Pkt. 10c, oz. 50c.

Garlic

The bulbs are set out like Onion sets, about 4 inches apart in the row, divided into "cloves" or flakes and covered 2 inches deep. Lb. 60c.

Horseradish Sets

Maliner Kren. A variety producing very large, pure white roots. Strong sets. Doz. 35c, 100 \$1.75.

Kale or Borecole

One ounce will produce about 3500 plants.

Early plants may be started in the hotbed, or the seeds may be sown in the open ground in April or May; transplant in June, into rows, and cultivate the same as Cabbage.

Dwarf Green Curled. One of the best; very hardy and improved by a moderate frost. Pkt. 10c, oz. 25c, $\frac{1}{4}$ lb. 75c.

Winter, or Siberian Greens (Sprouts). Sow in August or early in September in rows 1 foot apart. Pkt. 10c, oz. 25c, $\frac{1}{4}$ lb. 75c.

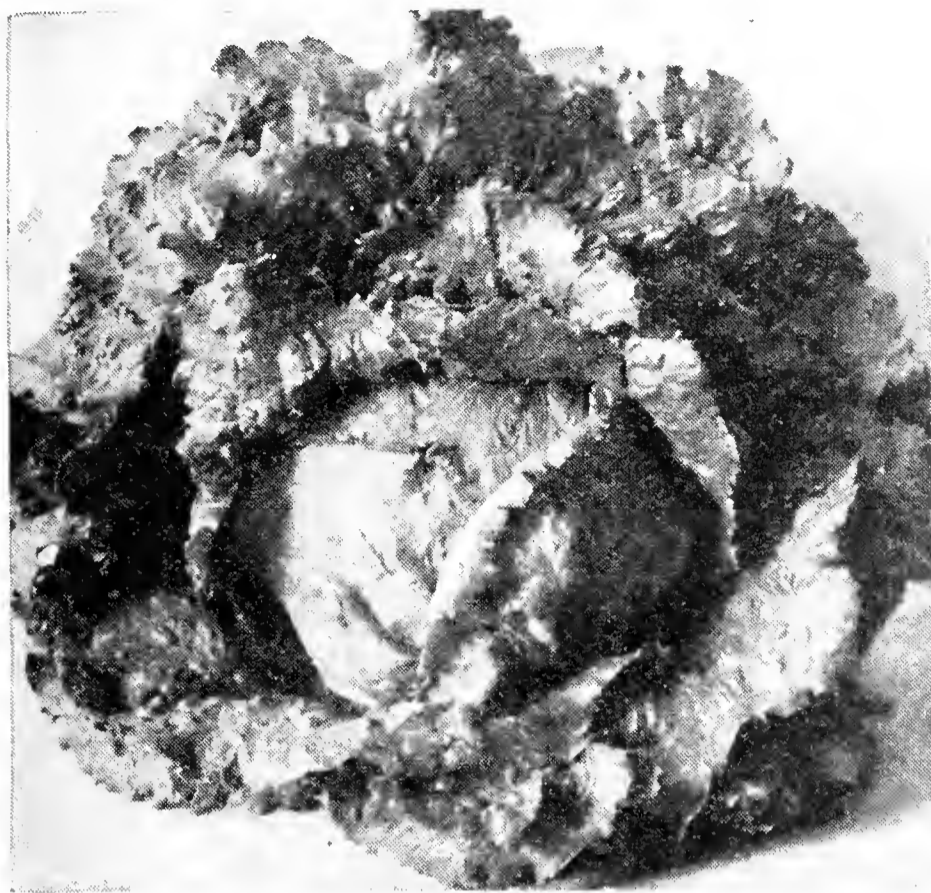

Wonderful or New York

LETTUCE

One ounce will produce about 3000 plants.

For early use, sow under glass in February or March, and transplant into a previously prepared hotbed; rows at least 12 inches apart, according to the varieties. Sowing may be made in the open ground as soon as all danger from frost is over; if a continuous supply is desired during season, make sowings every two or three weeks until September.

All the Year Round. A valuable variety, with compact, close heads. Pkt. 10c, oz. 40c, ¼ lb. \$1.25.

Big Boston. A most desirable variety either for forcing or open ground planting. Pkt. 10c, oz. 40c, ¼ lb. \$1.25.

Boston Curled. A variety highly esteemed for earliness and beauty of form. Pkt. 10c, oz. 40c, ¼ lb. \$1.25.

Black Seeded Mammoth Butter. The largest and considered by many the best variety for the late crop. Produces enormous formed heads of the finest quality. Pkt. 10c, oz. 40c, ¼ lb. \$1.25.

Deacon. Splendid variety for standing summer heat; large, solid heads, tender, crisp and sweet. Pkt. 10c, oz. 40c, ¼ lb. \$1.25.

French, Unrivaled. A sure heading variety, forming large, compact heads, and slow to run to seed. Pkt. 10c, oz. 40c, ¼ lb. \$1.25.

Giant Crystal Head. Outside leaves curled, with red edges. Heads large and solid. Pkt. 10c, oz. 40c, ¼ lb. \$1.25.

Grand Rapids. Crisp and tender, fine for forcing or outdoor culture. Pkt. 10c, oz. 40c, ¼ lb. \$1.25.

Hanson Improved. A superior, curled heading variety of large size, sweet, tender and crisp. Pkt. 10c, oz. 40c, ¼ lb. \$1.25.

Iceberg. A solid heading large variety of excellent quality. Pkt. 10c, oz. 50c, ¼ lb. \$1.50.

May King. Grows quickly and produces globe-shaped heads which are ten to fourteen days earlier than any other, and which stand a long time before going to seed. Pkt. 10c, oz. 50c, ¼ lb. \$1.50.

May King, Selected Strain. As a Lettuce for greenhouse forcing, this is the best; heads form very quickly, are firm and of fine quality. Pkt. 15c, oz. 75c, ¼ lb. \$2.00.

Mignonette. Very solid and compact and of a distinct russet color. Pkt. 10c, oz. 40c, ¼ lb. \$1.25.

Prize Head. Large, loose heads, tinged with brown. Pkt. 10c, oz. 40c, ¼ lb. \$1.25.

New York No. 12. A sure and reliable header and slow to shoot to seed. The heads are creamy white, sweet and tender, unsurpassed for spring and summer planting. Pkt. 10c, oz. 50c, ¼ lb. \$1.50.

Salamander. Fine compact heads which resist summer heat admirably. Pkt. 10c, oz. 40c, ¼ lb. \$1.25.

Simpson Early Curled. Early variety; good for forcing or open ground. Pkt. 10c, oz. 40c, ¼ lb. \$1.25.

Sutton's Supreme. A fine Lettuce of the Drumhead type, and a marked advance on other varieties of the same class. Attains a large size, with a firm heart, which remains good for a long time before starting seed stems. Leaves prettily edged with red. Pkt. 25c.

Tennis Ball, Black Seeded, Select Strain. A very popular sort for open ground culture; forms a handsome head and is crisp and tender. Pkt. 10c, oz. 50c, ¼ lb. \$1.50.

Tennis Ball, White Seeded. Extensively grown for forcing and heading under glass; heads firm and good size, very white and crisp. Pkt. 10c, oz. 40c, ¼ lb. \$1.25.

"Wayahead." Very early, with large, tightly folded heads; the outer leaves are light green, with the inner head finely blanched to a rich buttery yellow. Pkt. 10c, oz. 40c, ¼ lb. \$1.25.

White Boston. A sure, hard-heading variety, the heart and inner leaves are a rich yellow. It is deliciously flavored, very tender, of splendid quality. Pkt. 10c, oz. 50c, ¼ lb. \$1.50.

Wonderful, or New York Cabbage. One of the largest varieties. Wonderful heat resister; strong grower. Heads solid, crisp and tender. Pkt. 10c, oz. 50c, ¼ lb. \$1.50.

Romaine or Cos Lettuce

Sutton's Little Gem Cos. An entirely distinct Cos Lettuce, and a most valuable dwarf, compact variety. Dark green, small, solid, crisp, slow in running to seed, and of delicious quality. Pkt. 25c, ½ oz. 60c, oz. \$1.00.

Trianon Self-Closing Cos. The finest of the Cos varieties. Leaves long, narrow and erect. Pkt. 10c, oz. 40c, ¼ lb. \$1.25.

Leek

One ounce will sow 100 feet of drill

Sow as early in spring as practicable, in drills 1 inch deep and 1 foot apart. When 6 or 8 inches high, transplant in rows 10 inches apart each way, setting them deep, that the neck, being covered, may be blanched.

Musselburgh, or Scotch. A very large variety of superior quality. Pkt. 10c; oz. 50c, ¼ lb. \$1.25.

Giant Carentan. Large size and extra fine quality. Pkt. 10c, oz. 35c, ¼ lb. \$1.00.

Large Flag Winter. Desirable for market or family use. Pkt. 10c, oz. 35c, ¼ lb. \$1.00.

Large Rouen. Grows to a large size and keeps well. Pkt. 10c, oz. 35c, ¼ lb. \$1.00.

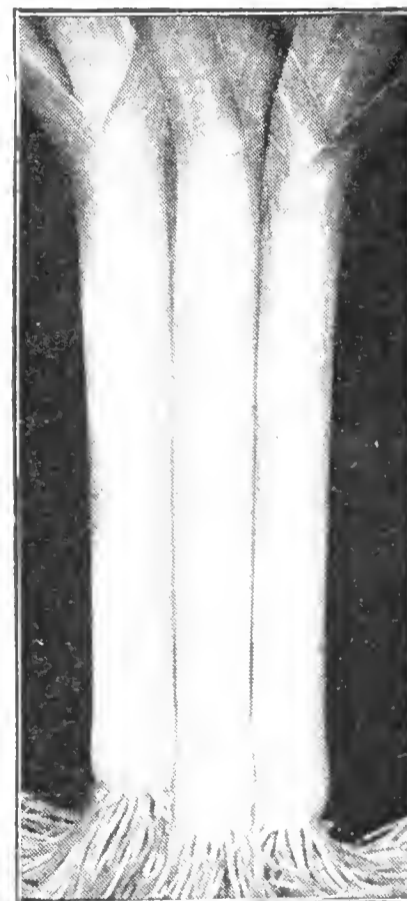

Leek

Martynia

One ounce will plant 100 hills.

Sow in the open ground in May, and thin out the plants to 2 or 3 feet apart, or a few seeds may be sown in a hotbed and afterward transplanted.

Proboscidea. Pkt. 10c, oz. 50c.

Muskmelon

One ounce will plant 60 hills, two to three pounds for an acre.

Plant in May, six to eight seeds to the hill, and when the plants are well up, thin out to three. Cultivate until the vines cover the ground, and pinch the ends of the growing shoots to induce early fruiting.

Green and Yellow Fleshed Varieties

Extra Early Hackensack. Large size, round shape, deeply ribbed, roughly netted; flesh green, very sweet, and highly flavored. Pkt. 10c, oz. 25c, $\frac{1}{4}$ lb. 75c.

Honey Ball. Flesh silvery green; juicy, with sweet honey-like flavor. Pkt. 10c, oz. 25c, $\frac{1}{4}$ lb. 75c.

Honey Dew. The melons are large, round to oval in shape. The light green flesh is luscious, juicy, solid, and of honey-like flavor. Pkt. 10c, oz. 25c, $\frac{1}{4}$ lb. 75c.

Miller's Cream. Nearly round, light green netted skin, with yellow flesh. Quality good. Pkt. 10c, oz. 25c, $\frac{1}{4}$ lb. 75c.

Rocky Ford. One of the best varieties. Flesh thick and green; sweet and luscious. Pkt. 10c, oz. 25c, $\frac{1}{4}$ lb. 75c.

Red or Salmon Fleshed Varieties

Bender's Surprise. It is medium early with deep orange flesh, which is very thick and deliciously sweet. Pkt. 10c, oz. 25c, $\frac{1}{4}$ lb. 75c.

Delicious. An early variety. The fruits are large; flesh deep orange color and very sweet. Pkt. 10c, oz. 35c, $\frac{1}{4}$ lb. \$1.00.

Emerald Gem. Small, extra early; smooth, ribbed, dark green skin and orange flesh; sweet. Pkt. 10c, oz. 25c, $\frac{1}{4}$ lb. 75c.

Grey's Selected A-1. Flesh deep orange color, very thick and sweet with a delicious flavor, large size and very productive. Pkt. 25c, oz. \$1.00, $\frac{1}{4}$ lb. \$3.00.

Hale's Best. An early variety, flesh is very thick and fine flavored. Pkt. 10c, oz. 25c, $\frac{1}{4}$ lb. 75c.

Hearts of Gold. Flesh very thick, deep salmon color, and of high quality. Pkt. 10c, oz. 25c, $\frac{1}{4}$ lb. 75c.

Lake Champlain (Golden Champlain). An exceedingly early salmon-fleshed Melon of medium size and fine quality. Pkt. 10c, oz. 25c, $\frac{1}{4}$ lb. 75c.

Oka. The color is a beautiful cream; flesh, a bright salmon color; sweet and juicy. Pkt. 50c.

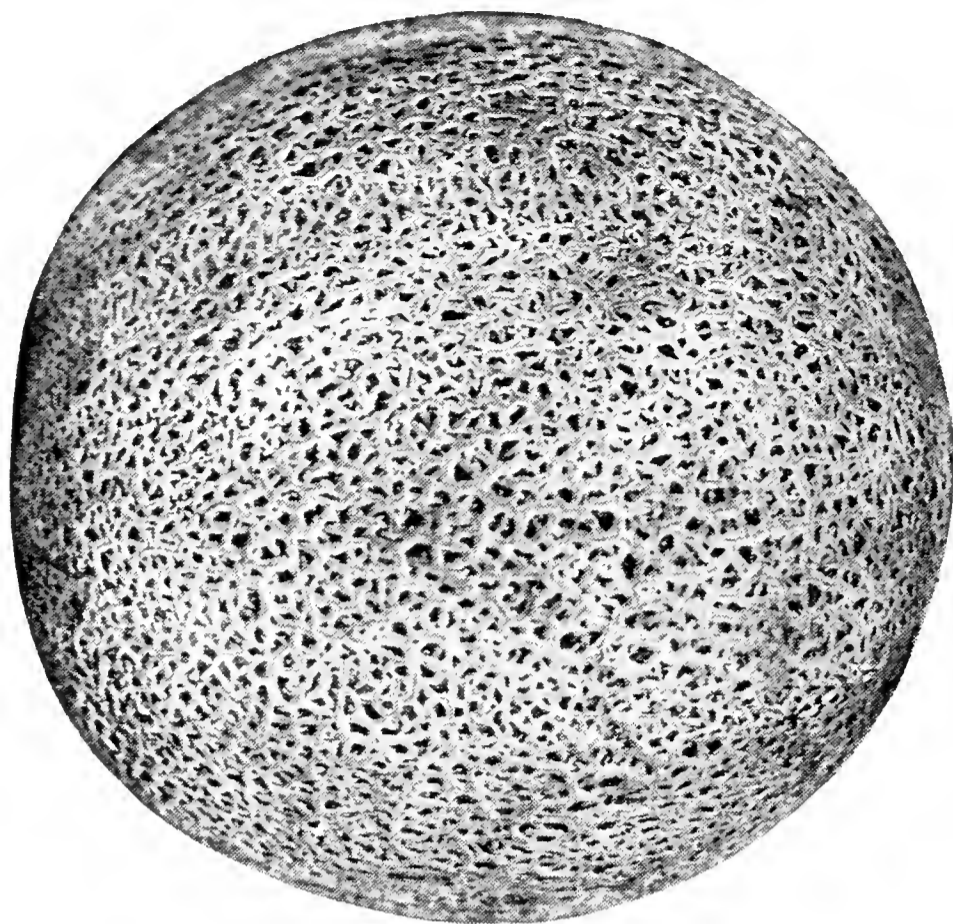

Rocky Ford Muskmelon

Muskmelons for Forcing

Blenheim Orange. Handsome scarlet flesh, superb flavor. Pkt. 50c.

Cotting's Hybrids. Flesh orange, oval shaped, delicious flavor. Pkt. 50c.

Hero of Lockinge. Fruit handsome, flesh white, extremely rich in flavor. Pkt. 50c.

King George. Scarlet flesh, yellow skin, large, luscious fruits. Pkt. 50c.

Superlative. Flavor exceptionally fine, scarlet flesh, round fruits; very productive. Pkt. 50c.

Sutton's A-1. Rich scarlet flesh, large globular fruits; fine flavor. Pkt. 50c.

Watermelon

One ounce will plant 30 hills. Four pounds will plant one acre.

Cultivate in the same manner as Muskmelons, but plant 8 to 10 feet apart.

Cole's Early. Very early variety; flesh very deep and sweet; color light green striped. Pkt. 10c, oz. 20c, $\frac{1}{4}$ lb. 60c.

Colorado Preserving. This is more productive than the common preserving Citron, and larger; the flesh is firm and solid. Pkt. 10c, oz. 20c, $\frac{1}{4}$ lb. 60c.

Dixie Queen. Fruit round or blunt, oblong, gray with prominent dark green stripes. Flesh richly colored, firm, sweet and juicy with very small white seeds. Pkt. 10c, oz. 20c, $\frac{1}{4}$ lb. 60c.

Early Fordhook. Extra early, good size, green skin, red flesh. Pkt. 10c, oz. 20c, $\frac{1}{4}$ lb. 60c.

Mountain Sweet. One of the best; rind thin, flesh scarlet, solid, very sweet and delicious. Pkt. 10c, oz. 20c, $\frac{1}{4}$ lb. 60c.

Phinney's Early. An early variety, of medium size; red fleshed, quality excellent. Pkt. 10c, oz. 20c, $\frac{1}{4}$ lb. 60c.

Tom Watson. The flesh is rich red color, solid, sweet and luscious. Pkt. 10c, oz. 20c, $\frac{1}{4}$ lb. 60c.



Cole's Early Watermelon



Mushrooms

One brick of Mushroom Spawn is sufficient for 10 square feet of bed.

For the bed, use a mixture of horse manure and good fresh loam. Before being placed in the bed let the material be thoroughly mixed and well turned three or four times. To prevent violent heating it is good policy to mix thoroughly with the manure, about one fourth its bulk of good loamy soil and oak leaves. In making up the bed, tread it firmly and, if necessary, wet it slightly. Leave it thus for about a week, or till the temperature of the bed has subsided to 70 to 75 degrees. Then make holes about 10 inches apart and put in each a piece of spawn about the size of a walnut. Cover the holes and press the soil solid and smooth. Mushrooms will appear in six or eight weeks from time of spawning. The bed will continue bearing about a month. No mushrooms can develop if the temperature is insufficient; the bed should not be below 70 degrees at time of spawning, and the atmospheric temperature not below 65 degrees.

If wanted by mail, add postage at parcel post rates.

BRICK SPAWN, AMERICAN PURE CULTURE

Ten bricks will spawn 100 square feet (10x10 ft.)

Spores have been selected from specimen Mushrooms and transferred to bricks of compressed manure and loam. Break the brick into pieces the size of a walnut and plant 1 foot apart each way.

Per brick (about 1½ lbs.)	\$0.40
Per 10 bricks	3.50
Per 25 bricks	7.50
Per 100 bricks	30.00

BOTTLE SPAWN

One quart will spawn 35 square feet. In this new method the mushroom spawn is the very best that can be produced. All materials have been sterilized and the spawn grown under absolutely germ-proof conditions. Each unit individually packed and containing complete instructions for the grower.

Quart	\$ 1.25
6 qts.	6.50
12 qts.	12.00

The Book—"Modern Mushroom Culture" by Dr. J. Franklin Styer. It is the most modern, reliable treatise available. \$1.50 a copy.

Mustard

One ounce will sow 50 feet of drill.

Green mustard imparts a delightfully pungent flavor to the various forms of prepared salads. For early crops the seed may be sown in a hotbed in March, and for general crop at frequent intervals through the spring, in drills from 8 to 12 inches apart.

Chinese Broad-leaved. Leaves much larger than the white Mustard. Flavor pleasantly sweet and pungent. Can be cooked like Spinach. Pkt. 10c, oz. 25c, ¼ lb. 75c, lb. \$2.00.

Fordhook Fancy. Very ornamental. Plants of vigorous growth; cooked same as Spinach. Pkt. 10c, oz. 25c, ¼ lb. 75c, lb. \$2.00.

White. Much used for salads; the seed is also used medicinally, and as a seasoning for pickles. Pkt. 10c, oz. 25c, ¼ lb. 75c, lb. \$2.00.

Mustard Spinach

Tendergreen. A variety of greens producing large dark green leaves, fairly smooth, with light green center ribs; slow to seed, resistant to heat and drought; combines the flavor of mustard and spinach. It is ready for table or market in 21 to 25 days after planting. An excellent addition to the list of greens. Pkt. 10c, oz. 25c, ¼ lb. 75c, lb. \$2.00.

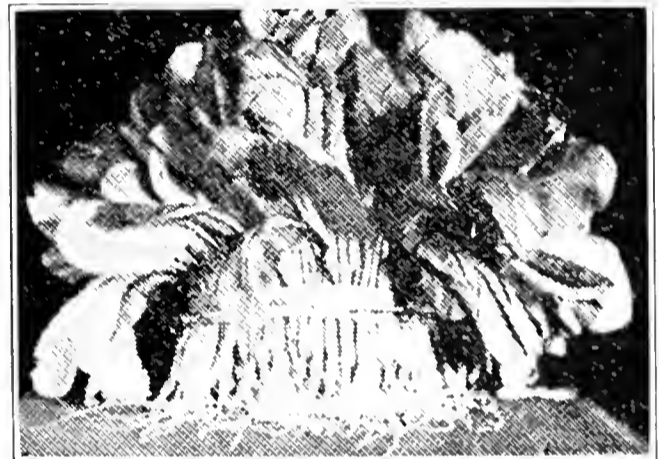

Mustard Spinach

Okra or Gumbo

One ounce will sow 40 feet of drill.

This plant is extensively cultivated for its green pods, which are used in soups and stews, and are very wholesome and nutritious. Sow about the middle of May, in drills 3 feet apart, and thin out the plants to 1 foot apart.

Improved Dwarf Green. Very early; smooth pods. Pkt. 10c, oz. 20c, ¼ lb. 60c.

White Velvet, or Creole. Pods smooth, of large size, and a creamy white. Pkt. 10c, oz. 20c, ¼ lb. 60c.

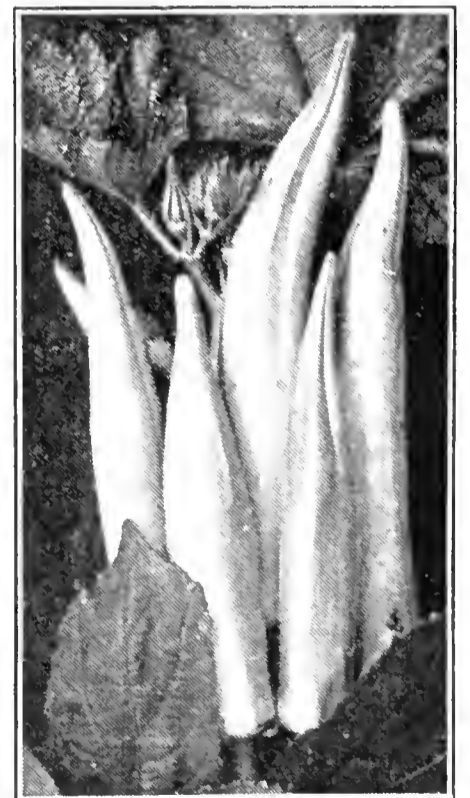

White Velvet Okra

Standard Mushroom or Hotbed Thermometers

Boxwood, metal tipped. Price \$3.00 each. Thermometers should whenever possible be sent by Express. We do not guarantee safe arrival if forwarded by Parcel Post.

Onions

One ounce will sow 100 feet of drill. Four or five pounds to the acre.

The Onion thrives best in light, loamy, mellow soil. The seed should be sown as early in the spring as the ground is in good working condition, in drills 14 inches apart, and covered $\frac{1}{4}$ inch deep. Keep free from weeds. A top dressing of wood ashes, applied after the second weeding, is very beneficial.

Ailsa Craig. Grows to a large size; very mild flavor; pale yellow. A valuable exhibition variety. Pkt. 25c, oz. \$1.00, $\frac{1}{4}$ lb. \$3.00.

Barletta. A very early, small, pure white variety, flesh firm and mild in flavor. Excellent for pickling. Pkt. 15c, oz. 60c, $\frac{1}{4}$ lb. \$2.00.

Cranston's Excelsior. Handsome globe-shaped variety; large, solid, with small neck; straw color. An exhibition variety. Pkt. 25c, oz. \$1.00.

Danvers Yellow Globe. Selected with the greatest care; the true shape and color; a reliable and sure cropper. Pkt. 10c, oz. 50c, $\frac{1}{4}$ lb. \$1.50.

Danvers Yellow Globe. Selected Strain. The finest type of this popular variety on the market. Pkt. 25c, oz. \$1.00, $\frac{1}{4}$ lb. \$3.00.

Ebenezer or Japanese. A dark yellow variety often used for Onion sets. Bulbs are deep, flat, of medium size, very firm, with a thick skin. Early and of good keeping quality. Pkt. 10c, oz. 50c, $\frac{1}{4}$ lb. \$1.50.

Gigantic Gibraltar. A handsome straw-colored Onion of enormous size, possessed of many sterling qualities. Grand for exhibition. Pkt. 25c, oz. \$1.00.

Large Red Wethersfield. The leading red variety of the East; almost round; deep red color; grows to good size and is a good keeper. Pkt. 10c, oz. 50c, $\frac{1}{4}$ lb. \$1.50.

Mammoth Silver King. Of attractive shape, with silvery white skin and flesh of a most agreeable mild flavor. Pkt. 10c, oz. 50c, $\frac{1}{4}$ lb. \$1.50.

Prizetaker. Of a rich straw color and enormous size, averaging 12 to 14 inches in circumference. Pkt. 10c, oz. 50c, $\frac{1}{4}$ lb. \$1.50.

Southport Red Globe. A good late sort. Keeps well. Pkt. 10c, oz. 50c, $\frac{1}{4}$ lb. \$1.50.

Southport Yellow Globe. A fine large variety. Somewhat later than the Danvers. Pkt. 10c, oz. 50c, $\frac{1}{4}$ lb. \$1.50.

Sweet Spanish. A handsome globe-shaped Onion of the largest size, skin light yellow, flesh white and very mild. Eating and keeping qualities excellent. Pkt. 10c, oz. 50c, $\frac{1}{4}$ lb. \$1.50.

The Queen. A handsome silver-skinned variety; esteemed for its rapid growth, mild flavor and fine keeping qualities. Pkt. 10c, oz. 50c, $\frac{1}{4}$ lb. \$1.50.

White Globe. Of mild flavor; skin silvery white; flesh fine grained, good keeper. Pkt. 10c, oz. 50c, $\frac{1}{4}$ lb. \$1.50.

White Lisbon. Grown as an early bunching onion. When mature the round, white bulbs are almost 3 inches in diameter. Pkt. 10c, oz. 50c, $\frac{1}{4}$ lb. \$1.50.

White Portugal, or Silverskin. Bulbs of medium size; flattened; skin silvery white; flesh fine grained and mild flavored. Pkt. 10c, oz. 50c, $\frac{1}{4}$ lb. \$1.50.

Onion Sets

Prices Variable

These are small Onions grown the previous year, ripened off and taken up when mere bulblets. They produce a very early crop, and grow in any good soil. Set them 3 or 4 inches apart in rows 1 foot apart.

If ordered by mail, add postage.

Shallots. Much used in soups, salads, etc. Qt. 50c, 4 qts. \$1.75, pk. \$3.25.

Japanese Yellow Onion Sets. The best variety of yellow sets for earliness, quality and production. Qt. 30c, 4 qts. \$1.00, pk. \$2.00.

White Sets. The best for general use, early, and of fine flavor. Qt. 35c, 4 qts. \$1.25, pk. \$2.25.

Yellow Sets. Preferred by some to white sets. Qt. 30c, 4 qts. \$1.00, pk. \$2.00.

Parsley

One ounce will sow 150 feet of drill.

Parsley succeeds best in rich, mellow soil, and as the seed germinates slowly—sometimes remaining in the earth four or five weeks before the plants appear—the sowing should be made as early in spring as the ground is in working condition. Can also be sown in hotbed in February. When the plants are 2 or 3 inches high, thin them out to 8 or 10 inches apart. The leaves of the curled varieties are used for garnishing, also for flavoring soups and stews.

Double Curled. Dwarf, finely curled; excellent for table and edgings. Pkt. 10c, oz. 25c, $\frac{1}{4}$ lb. 75c.

Dobbie's Exhibition. This Parsley has long been recognized as a standard exhibition sort. It is remarkable for its large, fine leaves and close habit. The seed offered has been saved from selected plants only; every one was a perfect specimen. Pkt. 25c, oz. 75c.

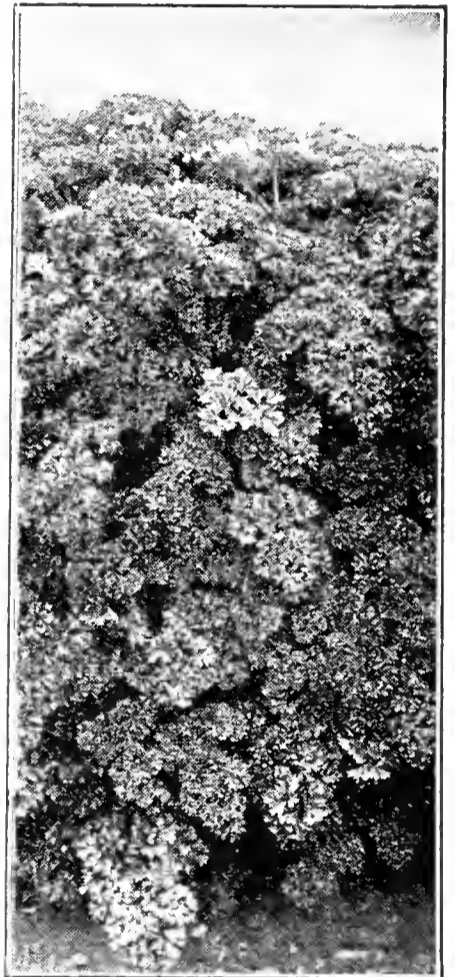

Grey's Perfection Parsley

Grey's Perfection. Beautifully curled and highly ornamental. Pkt. 25c, oz. 75c.

Hamburg, or Rooted. The roots are used for flavoring. Pkt. 10c, oz. 30c, $\frac{1}{4}$ lb. \$1.00.

Moss Curled. One of the finest varieties for garnishing on account of its mossy appearance and its bright color. Pkt. 10c, oz. 25c, $\frac{1}{4}$ lb. 75c.



Southport Red Globe

Danvers Yellow Globe

Red Wethersfield

PEAS

Two lbs. of peas will plant 100 feet of drill; 90 lbs., to the acre.

Peas succeed best in light, rich soil. The early round, smooth varieties should be planted as early in spring as possible, while the wrinkled sorts, which are more tender, will do better if planted after the ground becomes warmer. Sow in drills, 2 to 3 feet apart, according to variety, and cover early sowing about 2 inches; later plantings should be covered 3 to 4 inches. Successive plantings can be made every ten days up to the middle of July. For the later plantings the early varieties are preferred.

Free Delivery. We will prepay Parcel Post charges on cash orders at quoted catalogue prices on Peas, up to two pounds, anywhere in the United States, east of the Mississippi River; for larger quantities, the purchaser pays transportation charges.

We furnish 15c packages of all kinds of Peas, except where noted.

Before planting Peas
inoculate seed with



Alaska or Clipper. A valuable variety either for private use or for market. Pods well filled. 2½ ft. Lb. 25c, 2 lbs. 45c, 7 lbs. \$1.40.

Blue Bantam. A fine extra early wrinkled Pea. Large pods well filled with deep green, fine flavored Peas. Height 2¼ ft. Lb. 30c, 2 lbs. 55c, 7 lbs. \$1.75.

Early Morn. Of Gradus type. Early, with large pods and Peas of good flavor. 3 ft. Lb. 30c, 2 lbs. 55c, 7 lbs. \$1.75.

Gradus. (Prosperity). Large, handsome pods, well filled, ripening with the earliest; pods long, straight, slightly rounded at the point. 3 ft. Lb. 30c, 2 lbs. 55c, 7 lbs. \$1.75.

Grey's Perfection. One of the earliest Peas in cultivation; the pods, which are numerous, contain six or seven good-sized Peas. Very productive and of fine flavor. 2½ ft. Lb. 30c, 2 lbs. 55c, 7 lbs. \$1.75.

Hundredfold. A splendid large-podded dwarf variety; the pods are 4 inches long and well filled with large deep green Peas of fine quality. The vines grow 16 to 18 inches high and very strong. This is one of the best dwarf early Peas for the home garden and market. Lb. 30c, 2 lbs. 55c, 7 lbs. \$1.75.

Laxton's Progress. This is the finest new early dwarf Pea Laxton has ever yet raised; wrinkled, averaging 9 to 10 Peas to a pod. The pods are dark green, height 18 to 24 in. Lb. 30c, 2 lbs. 55c, 7 lbs. \$1.75.

Laxton's Superb. A splendid early semi-wrinkled variety. Hardy and very productive. Pods large and well-filled. Height 18 inches. Lb. 35c, 2 lbs. 60c, 7 lbs. \$2.00.

Laxtonian, Re-Selected. This fine new Pea has been carefully selected, and the stock now offered is saved from deep green, giant pods only. Pods are slightly curved and deep green Peas are of excellent flavor. Lb. 30c, 2 lbs. 55c, 7 lbs. \$1.75.

Little Marvel. This is one of the best dwarf Peas; a heavy cropper and of best quality. Pods green, blunt-ended and well filled. Lb. 30c, 2 lbs. 55c, 7 lbs. \$1.75.

Nott's Excelsior. An improvement on American Wonder, being more vigorous and prolific, with large pods and more Peas. Height 15 in. Lb. 25c, 2 lbs. 40c, 7 lbs. \$1.25.

Pilot. An extra early round-seeded or smooth Pea. Can be planted as soon as ground can be worked. Pods as large as the Gradus. Very prolific, highly recommended as an extra early market sort. Lb. 30c, 2 lbs. 55c, 7 lbs. \$1.75.

Sutton's Pioneer. A first early Pea which has won great popularity for its many excellent qualities. Height about 2 ft. Lb. 30c, 2 lbs. 55c, 7 lbs. \$1.75.

Sutton's Excelsior. An extra early, dwarf, wrinkled Pea, fully as early as the American Wonder, with much broader pods, filled with large Peas of the finest flavor. 1½ ft. Lb. 25c, 2 lbs. 40c, 7 lbs. \$1.25.

Thomas Laxton. One of the best early wrinkled Peas yet introduced; very productive with large, well-filled pods. 3 ft. Lb. 30c, 2 lbs. 55c, 7 lbs. \$1.75.

World's Record. An earlier strain of the well-known Gradus Peas. Medium green, moderately stout vines, bearing medium green pods, 4 inches long, which are fairly broad, pointed and well filled with from 7 to 9 very fine dark green Peas. Lb. 30c, 2 lbs. 55c, 7 lbs. \$1.75.

Second Early and Late Varieties

Alderman. A large-podded wrinkled Pea of robust habit. Pods 4 to 5 inches long, well filled with Peas of excellent flavor. 3½ ft. Lb. 35c, 2 lbs. 60c, 7 lbs. \$2.00.

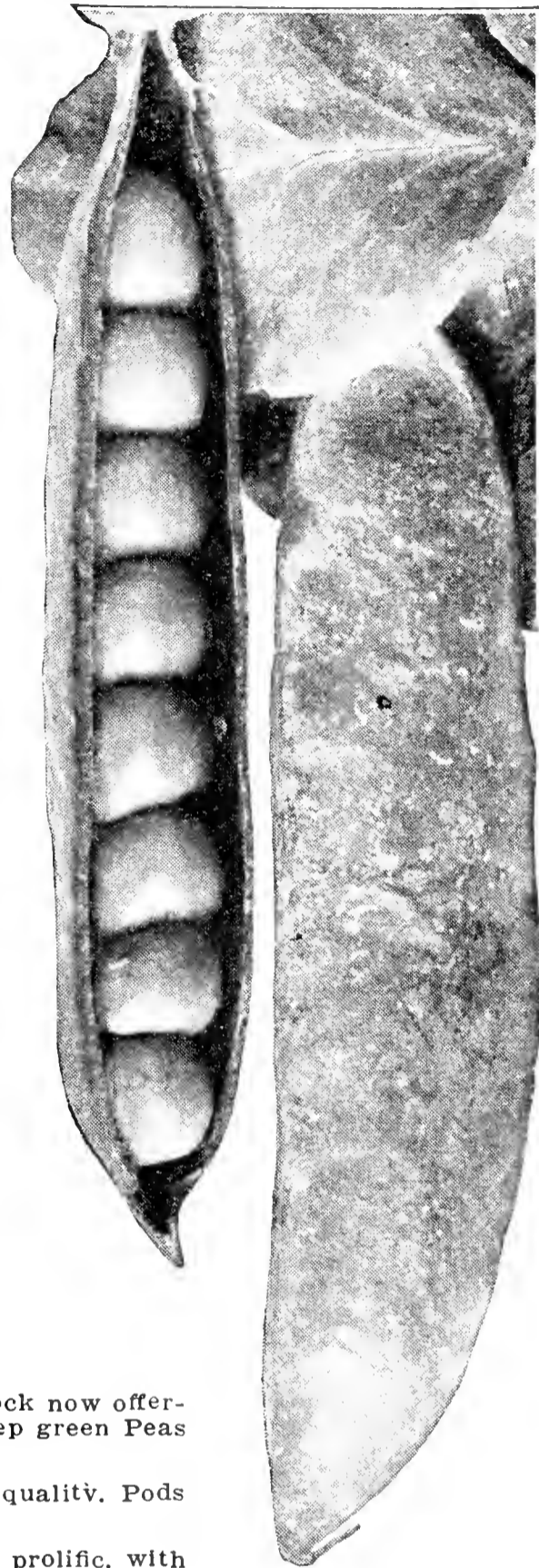

Gradus Peas

Admiral Beatty. A new and very popular variety, highly productive and of excellent quality. Height 4 feet, pods large, green, and produced in pairs. Lb. 35c, 2 lbs. 60c, 7 lbs. \$2.00.

Canada Field. See page 66.

Champion of England. A standard variety; very sweet and delicious. One of the best and most popular. 5 ft. Lb. 35c, 2 lbs. 60c, 7 lbs. \$2.00.

Dwarf Telephone. Season medium. Pods long, remarkably well filled, color pale green; peas large, tender and of delicious flavor. 1½ ft. Lb. 30c, 2 lbs. 55c, 7 lbs. \$1.75.

Everbearing Bliss. A continuous bearing variety of especial value for late summer and autumn. Pods 3 to 4 in. long, producing 6 to 8 large wrinkled peas; quality unsurpassed. 2 ft. Lb. 30c, 2 lbs. 55c, 7 lbs. \$1.75.

French Canner (Petit Pois). Very prolific, with long slim, curved pods, containing seven to nine peas. 3 to 3½ ft. Lb. 50c, 2 lbs. 90c, 7 lbs. \$2.75.

Mammoth Melting Sugar. Best of all the edible-podded Peas. Pods straight, smooth, brittle and delicious. 3 ft. Lb. 40c, 2 lbs. 75c, 7 lbs. \$2.25.

Peas—Continued

Sutton's Super V. C. The largest podded Pea in existence; height from 5 to 6 ft. Large pods of fine flavor, an exhibition variety. Lb. 75c, 2 lbs. \$1.40, 7 lbs. \$4.00.

Onward. Decidedly the best Pea of recent introduction; pods are 4 in. long with 6 to 8 deep green peas of the finest flavor. Lb. 40c, 2 lbs. 75c, 7 lbs. \$2.25.

The Britisher. Pods are perfectly straight; pointed at the ends, and of a medium green color, containing large, nicely flavored peas. 4 ft. Main crop; wrinkled. Pkt. 35c, lb. \$1.25, 2 lbs. \$2.00.

Quite Content, Carter. A main crop variety; grows 5 feet high; foliage and pod deep green; pods 6 to 7 in. long, hanging mostly in pairs; ten to twelve pears in a pod. Flavor superb. Lb. 40c, 2 lbs. 75c, 7 lbs. \$2.25.

Stratagem. A heavy cropper, and produces large, remarkably well filled pods of excellent flavor. One of the best. 2 ft. Lb. 30c, 2 lbs. 55c, 7 lbs. \$1.75.

Telephone. Immensely productive, the pods are of large size and closely packed with large, delicious peas. 4 ft. Lb. 30c, 2 lbs. 55c, 7 lbs. \$1.75.

The Gladstone. One of the best late Peas; immense cropper, long, curved, deep green, well filled pods. 3½ ft. Lb. 40c, 2 lbs, 75c, 7 lbs. \$2.25.

The Miracle. An early main crop, wrinkled variety. Height 4 feet, pod long, very deep green, well filled with peas of rich color and exquisite flavor. A heavy cropper. Pkt. 35c, lb. \$1.25, 2 lbs. \$2.00.

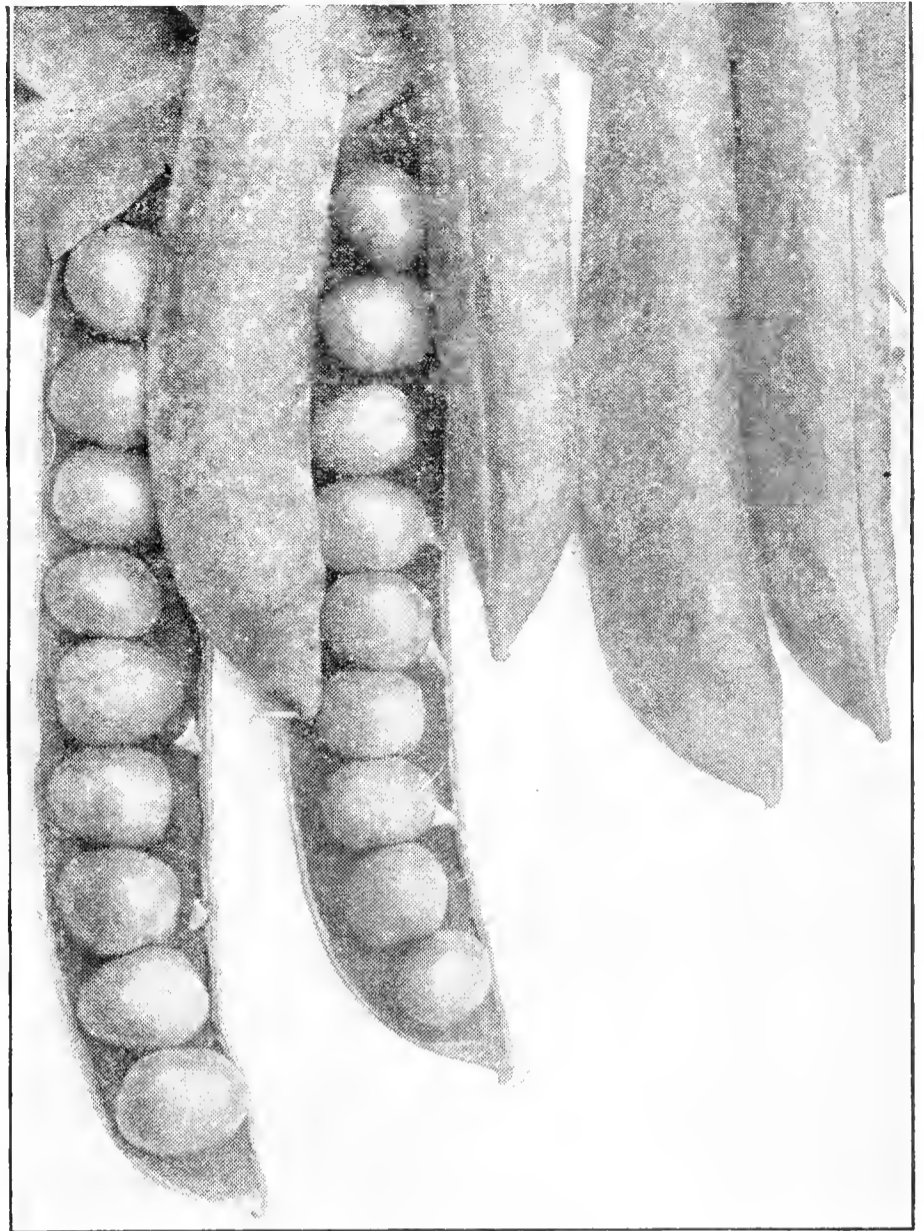

Telephone Peas

Before planting Peas inoculate seed with

The Original Legume Inoculator NITRAGIN Restores and Maintains Soil Fertility		LESPEDeza Unhulled or Hulled
INOCULATOR PRICES When Ordering, Always Specify Name of Seed Alfalfa, all Clovers		Size Retail 1 bu. ea.\$.35 2 bu. ea.55 5 bu. ea. 1.20
Size Retail ½ bu. ea.\$.35 1 bu. ea.55 2½ bu. ea. 1.20		Peanuts, Soy Beans, Cow Peas, Lima Beans
Vetch, Austrian Peas, Canadian Peas, Beans		Size Retail 1 bu. ea.\$.35 2 bu. ea.55 5 bu. ea. 1.20 10 bu. ea. 1.75 *25 bu. ea. 3.75 **25 bu. size.* Packed only for Soy Beans, Cow Peas.
Size Retail ½ bu. ea.\$.30 1 bu. ea.45 * 1⅓ bu. ea.65 5 bu. ea. 1.85 *12½ bu. ea. 4.25 **100 lb. size.* Packed only for Vetch and Peas.		New Garden Size NITRAGIN for Garden Peas, Beans, Sweet Peas, Lima Beans and Lupines Each package will inoculate any amount up to 4 lbs. seed. Retail Price\$10 ea.

Parsnips

One ounce will sow 100 feet of drill. Five to six pounds to the acre.

Sow in April or early in May, as Parsnips require a long season to mature. Their cultivation is otherwise the same as directed for Carrots. If left in the ground till the following spring, they are very much improved in flavor.

Arlington Long White. A good variety for general use; long and smooth. Pkt. 10c, oz. 25c, ¼ lb. 75c.

Early Round. The earliest variety in cultivation, of good flavor but of small size. Pkt. 10c, oz. 30c, ¼ lb. \$1.00.

Hollow-Crowned. Roots very long, white, smooth and sweet. Excellent flavor. Pkt. 10c, oz. 25c, ¼ lb. 75c.

Student. A favorite English variety; tender and smooth. Pkt. 10c, oz. 30c, ¼ lb. \$1.00.

Pepper

One ounce will produce about 1500 plants.

Sow in March or April in a hotbed and transplant into open ground late in May or early in June when the weather has become well settled, as the plants are quite tender. Set in rows about 2 feet apart, and 15 inches apart in the row. A warm, sandy loam is best suited to their growth.

California Wonder. A sweet variety of great merit. Heavily productive over a long season. Fruits very large, smooth and regular. Pkt. 15c, oz. 75c, ¼ lb. \$2.00.

Chinese Giant. Very large, flesh mild and thick. Pkt. 10c, oz. 50c, ¼ lb. \$1.50.

Golden Dawn. A large yellow variety, resembling the Bell in shape. Mild and sweet. Pkt. 10c, oz. 50c, ¼ lb. \$1.50.

Harris Early Giant. The plants produce enormous yield. The Peppers are deep green turning to brilliant red. Flesh thick and of a very sweet flavor. Pkt. 15c, oz. 60c, ¼ lb. \$1.75.

Large Bell, or Bull Nose. Good for Mangoes; early, sweet and less pungent than many; one of the best. Pkt. 10c, oz. 50c, ¼ lb. \$1.50.

Long Red Cayenne. A long, slim pod, rather pointed, and when ripe, of a bright red color, extremely strong and pungent. Pkt. 10c, oz. 50c.

Neapolitan Large Early. The earliest of the large, sweet Peppers. Pkt. 10c, oz. 50c, ¼ lb. \$1.50.

Ruby King. Long, about 5 in.; very thick, fine, mild flavor. Pkt. 10c, oz. 50c, ¼ lb. \$1.50.

Squash. Flesh thick, mild and pleasant to the taste, though more piquant than some. Pkt. 10c, oz. 50c, ¼ lb. \$1.50.

Sunnybrook. The fruit measures 2½ to 3 in. thick and 2 to 2½ in. deep. The flesh is unusually thick and very sweet. Pkt. 10c, oz. 50c, ¼ lb. \$1.50.

Sweet Mountain. Grows to large size; shape somewhat like the Bell, but much larger. Pkt., 10c, oz. 50c, ¼ lb. \$1.50.

World Beater. Fruits large, oblong, commonly 5 inches long and 3½ inches in diameter; deep green becoming bright deep red; flesh thick and sweet. Pkt. 10c, oz. 50c, ¼ lb. \$1.50.

Potatoes

Eight to ten bushels will plant one acre.

Owing to unsettled market conditions prices will be given on application.

Make furrows of good depth, 3 feet apart. Scatter a liberal dressing of phosphate along the drill, and set the seed about 10 inches apart in the rows. Cover with about 2 inches of soil, and begin to cultivate when the plants are well up.

Delaware. Tubers large, smooth and of best quality; white and yield well.

Early Rose. The well known variety; early and prolific.

Green Mountain. (Certified Stock.) We can recommend this variety as one of the best for all purposes.

Irish Cobbler. (Certified Stock.) Cream white color and of excellent quality. A vigorous grower, early, ripens uniformly, and keeps well.

Rural Russet. A reliable late variety, practically blight-resistant. Quality excellent. A good keeper.

Spaulding Rose. A valuable late Potato of exceptional quality. Cooks white and mealy; does well in light soils.

Before planting Seed Potatoes treat seed with New Improved Semesan Bel. This is valuable for combating seed-borne rhizoctonia, seed scab, and rotting. One pound will treat 60 to 80 bushels. 4 oz., 45c; 1 lb., \$1.50; 5 lbs., \$6.75; 25 lbs., \$31.00.

Radish

One ounce will sow 100 feet of drill.

Sow in the open ground the last of April in light, rich, sandy soil, selecting a warm or sheltered location. Later sowings can be made at intervals during the summer in a moist location where they can grow quickly. Sow broadcast or in drills. Seeds of Winter Radishes should be sown during midsummer, and the Radishes can be kept during winter if covered with sand and placed in a cool cellar.

Early Crimson Giant. Grows to a large size without becoming pithy. Excellent for forcing. Pkt. 10c, oz. 25c, ¼ lb. 75c.

Earliest Forcing Deep Scarlet Turnip. Short leaved; very early; brilliant red; particularly fine for use in frames. Pkt. 10c, oz. 25c, ¼ lb. 75c.

Early Scarlet Globe. Of distinct shape, brilliant color, crisp and white; excellent for forcing. Pkt. 10c, oz. 25c, ¼ lb. 75c, lb. \$2.00.

Early Scarlet Turnip. Small, round Radish; very tender, mild and of quick growth. Pkt. 10c, oz. 15c, ¼ lb. 35c.

Early, Scarlet Turnip, White Tipped. A very early variety; color deep scarlet with white tip. Good forcer. Pkt. 10c, oz. 25c, ¼ lb. 75c.

French Breakfast. Scarlet, with white tip; shape nearly oval; good for forcing or summer sowing. Pkt. 10c, oz. 15c, ¼ lb. 35c.

Icicle. Quick growing; clear white. Fine for forcing. Pkt. 10c, oz. 25c, ¼ lb. 75c.

Long Black Spanish. One of the hardiest and best for winter use. Pkt. 10c, oz. 25c, ¼ lb. 75c.

Round Black Spanish. Skin black; roots globe-shaped; white fleshed and piquant flavor. Pkt. 10c, oz. 25c, ¼ lb. 75c.

Rose China Winter. Bright rose color, flesh firm and fine for winter use. Pkt. 10c, oz. 25c, ¼ lb. 75c.

Saxa. A popular Radish for both forcing and for outdoor use. The root is as round as a ball, and a bright scarlet color. As this variety is very early and the top very short, it is rapidly gaining favor. Pkt. 10c, oz. 25c, ¼ lb. 75c.

White Turnip. Very early, flesh and skin white, of mild flavor; excellent for summer use. Pkt. 10c, oz. 25c, ¼ lb. 75c.

White Stuttgart. A quick growing variety of large size and of good quality. Pkt. 10c, oz. 25c.

Sweet Potato Plants

Culture—The young plants should be set in hills about 4 feet apart and 5 inches above the ground level. A light soil and sunny location are preferable. Rooted slips ready in May.

Nansemond. Best sort for New England. Plants, \$1.25 per 100, \$10.00 per 1000; add 15c per 100 if wanted by parcel post.

Pumpkin

One ounce will plant 20 hills. One pound 250 hills.

Sow in good soil in May, when the ground has become warm, in hills 8 to 10 feet apart each way; or in fields of Corn, about every fourth hill. The Pumpkin is not so particular in regard to soil as the Melon or Cucumber, but in other respects is cultivated in a similar manner. If planted in hills by themselves, thin out the plants when beginning to run, to three in each hill.

Connecticut Field. A large yellow variety, productive, and grown for feeding stock. Pkt. 10c, oz. 15c, ¼ lb. 50c, lb. \$1.50.

Mammoth. A productive variety, which grows to an immense size, often weighing more than a hundred pounds. Pkt. 10c, oz. 25c, ¼ lb. 75c, lb. \$2.50.

Sugar. A small, fine-grained, sweet Pumpkin; very prolific and a fine table variety. Pkt. 10c, oz. 15c, ¼ lb. 50c, lb. \$1.50.

Winter Luxury. Flesh thick, sweet and excellent for pies. Pkt. 10c, oz. 25c, ¼ lb. 75c.

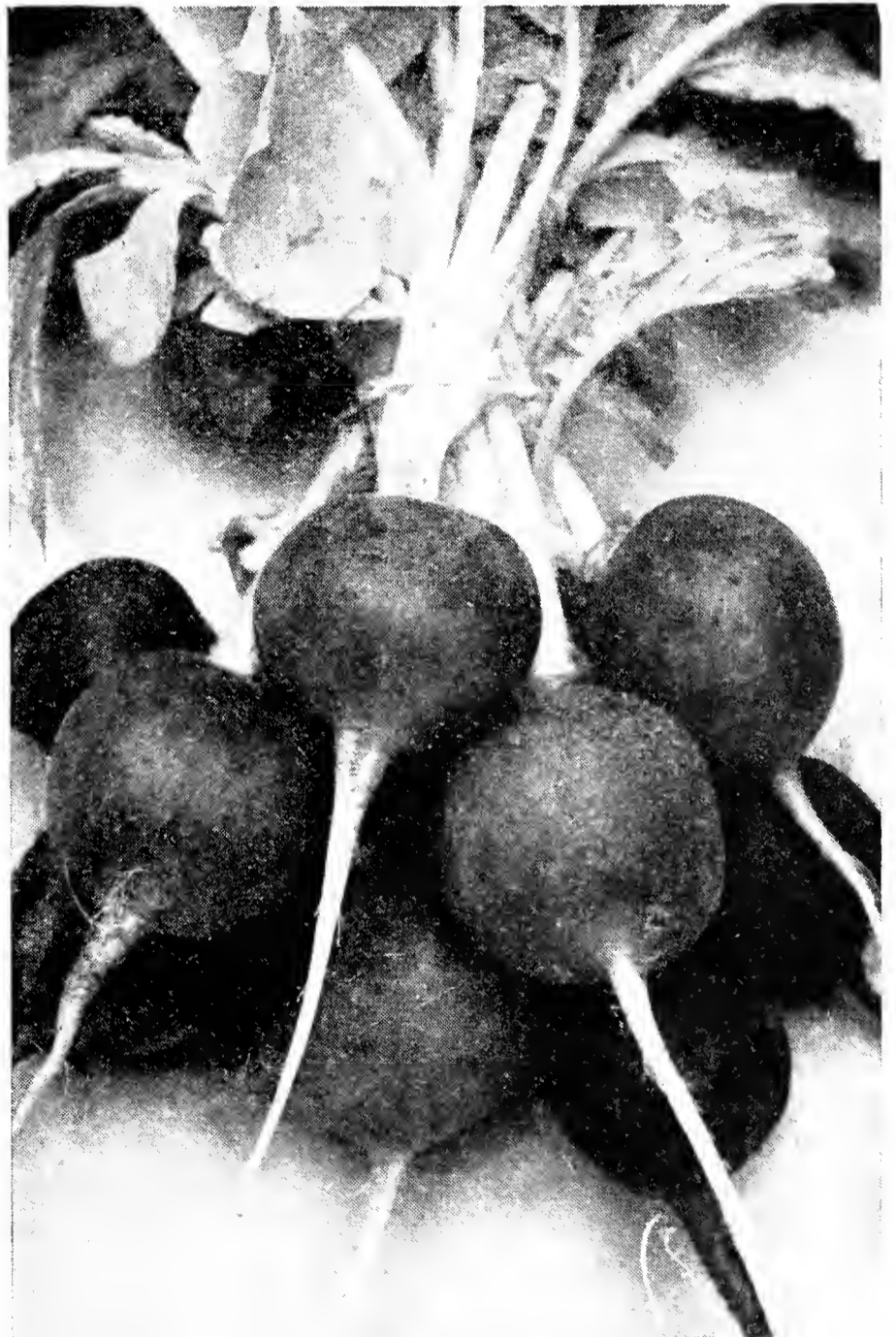

Early Scarlet Globe Radish

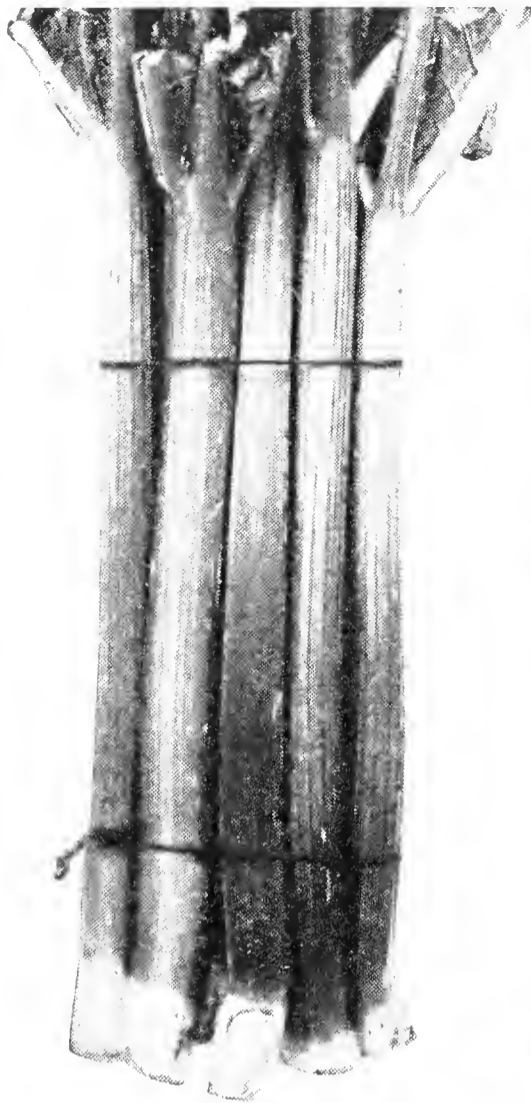

Linnaeus Rhubarb

Mammoth Sandwich
Island Salsify

Spinach

One oz. will sow 100 feet of drill; 12 lbs. will sow an acre.

For early use sow in August or September, in drills 12 to 14 inches apart. At the approach of cold weather cover lightly with straw, or any handy litter. Uncover when the plants begin to make a new growth in spring. For summer use sow early in spring in same way as above.

Packets 10c, except where noted.

Bloomsdale or Savoy-Leaved. A valuable variety with wrinkled leaves, resembling the Savoy Cabbage. Oz. 15c, ¼ lb. 35c, lb. \$1.00.

King of Denmark. Especially desirable for sowing during April and May. Oz. 15c, ¼ lb. 35c, lb. \$1.00.

Mustard Spinach. (See page 53.) Pkt. 10c, oz. 25c, ¼ lb. 75c, lb. \$2.00.

New Zealand (*Tetragonia expansa*). May be started in a hotbed and transplanted or sown out-of-doors when the ground is warm, allowing two feet between the plants. Pkt. 10c, oz. 25c, ¼ lb. 75c, lb. \$2.00.

Nobel. Giant-Leaved. By far the best of the so-called smooth-leaved varieties. Oz. 15c, ¼ lb. 35c, lb. \$1.00.

Perpetual or Spinach Beet. Produces green leaves in abundance close to the ground, and will give a constant supply through the season. Pkt. 10c, oz. 20c, ¼ lb. 50c.

Prickly Winter. A very hardy variety, for fall sowing and spring use. Oz. 15c, ¼ lb. 40c, lb. \$1.00.

Princess Juliana. The leaves are large; very dark green in color. A fine variety for the market. Oz. 15c, ¼ lb. 35c, lb. \$1.00.

Round Thick-Leaved. Leaves large, thick and fleshy; the variety generally grown for market and equally good for spring or fall sowing. Oz. 15c, ¼ lb. 35c, lb. \$1.00.

Savoy Blight-Resistant. A valuable variety to use for fall sowing. Oz. 15c, ¼ lb. 35c.

Savoy-Leaved, Long-Standing. Darker green and more heavily crumpled than Bloomsdale. Oz. 15c, ¼ lb. 35c.

Viking. A large, dark green leaved, long standing Spinach, grows very rapidly. Excellent for spring sowing. Oz. 15c, ¼ lb. 50c, lb. \$1.25.

Rhubarb

One ounce will produce about 750 plants.

Rhubarb succeeds best in deep, rich loam. It is propagated by seed, or by division of the roots—the latter being the usual method. Sow the seeds in drills 18 inches apart, and thin out the plants to 9 inches apart in the drills. When the plants are one year old transplant into beds, setting the plants 5 feet apart each way. Do not cut until the second year and give a liberal dressing of manure every fall.

Linnaeus. The earliest and best for garden use; not as coarse and fibrous as the larger sorts. Pkt. 10c, oz. 50c, ¼ lb. \$1.50.

Victoria. The variety in general use for the market; yields immense crops. Pkt. 10c, oz. 50c, ¼ lb. \$1.50.

Roots. Either variety. Each 35c, doz. \$3.00.

Salsify or Vegetable Oyster

One ounce will sow 50 feet of drill.

Sow the seed early in spring, in drills 12 inches apart and 1 inch deep, thinning out the young plants to 6 inches. The roots will be ready for use in October, when a supply should be taken up and stored like Carrots. Those remaining will suffer no injury by being left in the ground till spring.

Long White French. Pkt. 10c, oz. 35c, ¼ lb. \$1.25.

Mammoth Sandwich Island. Tender and delicious; very superior. Pkt. 10c, oz. 30c, ¼ lb. \$1.00.

Scorzoneria (Black Salsify). Cultivate the same as Salsify. The roots should not be scraped, but simply washed, boiled tender, then peeled and served like Asparagus. Pkt. 10c, oz. 50c, ¼ lb. \$1.50.

Sorrel

Broad-Leaved French. Used cooked as spinach or to mix with salads, sow seed in spring in good light soil in shallow drills one foot apart, thin out to four inches apart in the row; when the seed stalks appear, they should be cut out. Pkt. 10c, oz. 50c, ¼ lb. \$1.50, lb. \$4.00.

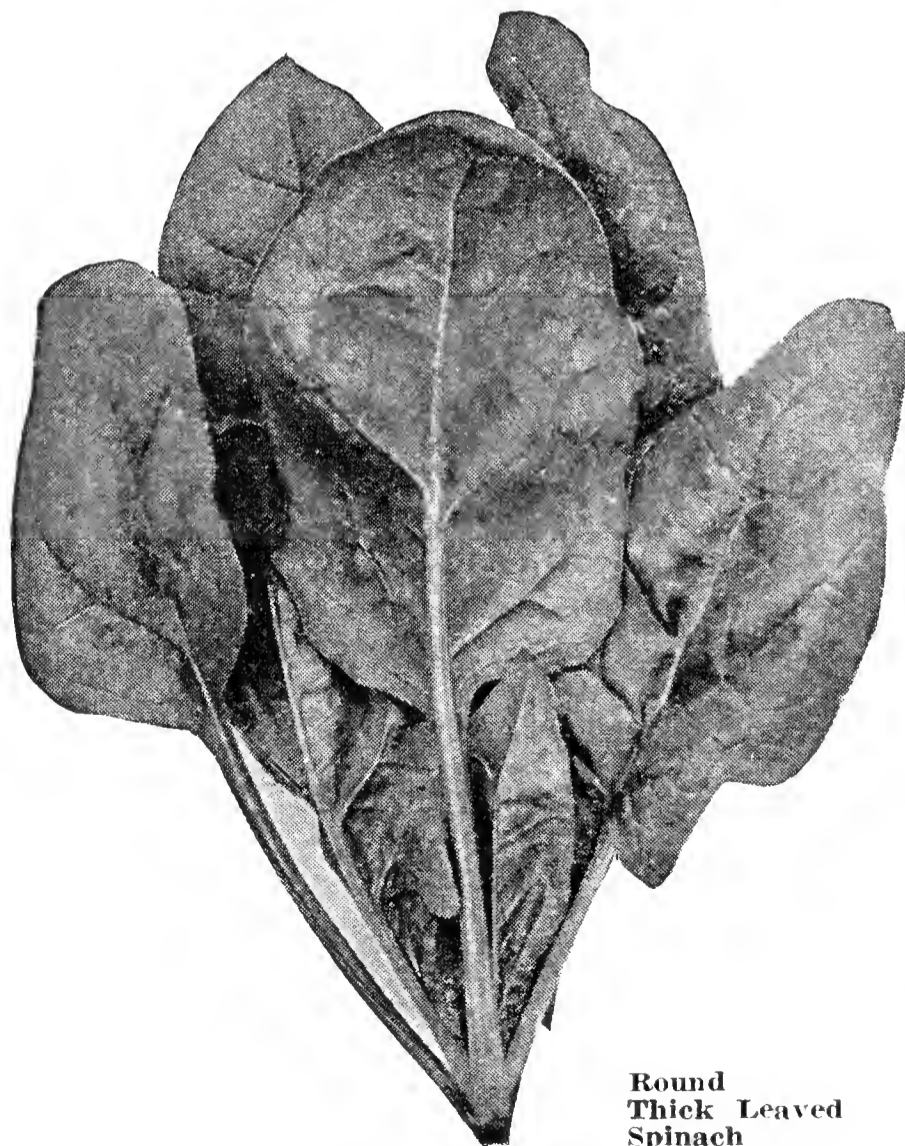
Round
Thick Leaved
Spinach

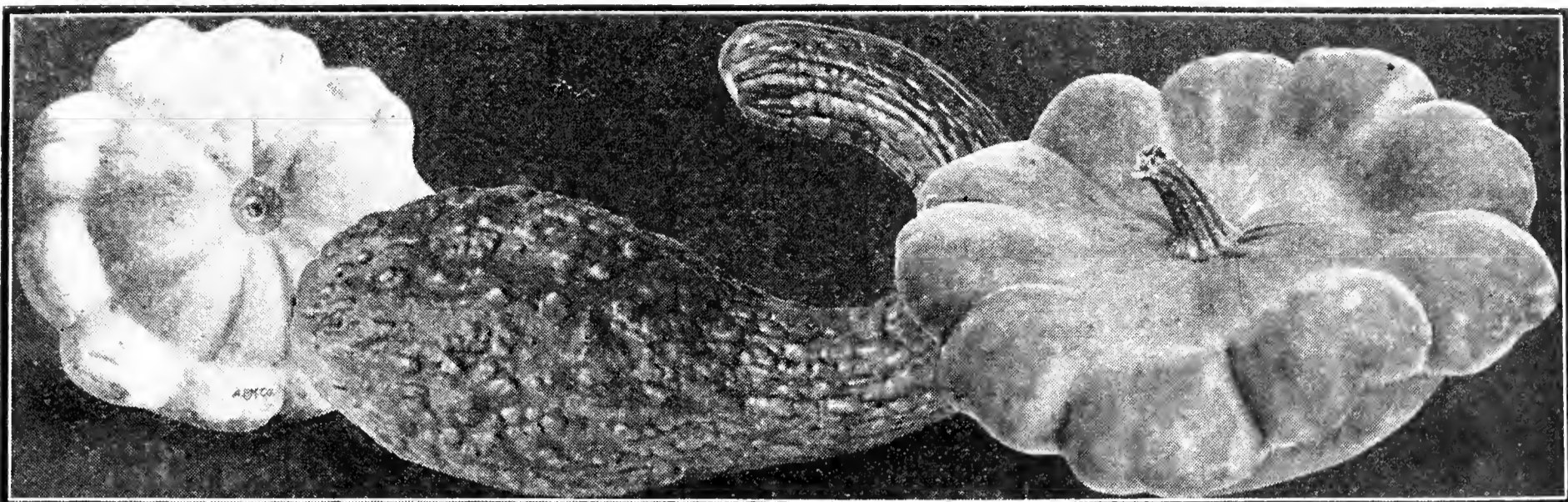

Early Mammoth White Scalloped

Giant Summer Crookneck

Early Yellow Scalloped

Squash

One ounce of the small-seeded variety will plant 40 hills; of large-seeded, 15 hills.

Squashes, being very tender and sensitive to cold, should not be planted until the weather becomes warm and settled. Plant in well-manured hills, in the same manner as Cucumbers and Melons, the bush varieties 3 or 4 ft. apart each way, and the running kinds from 6 to 8 ft. apart. Sow 8 to 10 seeds to a hill, thinning out after they have attained their rough leaves, and danger from bugs is past, leaving two or three of the strongest plants in each hill.

Bay State. Blue, shell hard; flesh fine and dry, of sweet flavor; bright golden yellow color. Pkt. 10c, oz. 25c, ¼ lb. 75c.

Boston Marrow. A fall and winter variety of oval form, skin thin; when ripe, bright orange; an excellent keeper and of superior quality. Pkt. 10c, oz. 25c, ¼ lb. 75c.

Delicious. One of the best varieties for table use. It is a fall and winter Squash, excellent at all seasons. Pkt. 10c, oz. 25c, ¼ lb. 75c.

Des Moines. It is a small, dark green, acorn-shaped Squash, almost black in color, usually about 6 inches long and 4 in. in diameter. Pkt. 10c, oz. 25c, ¼ lb. 75c.

Early Mammoth White Scalloped. One of the earliest summer Squashes; flat, scallop-shaped; light cream color. Pkt. 10c, oz. 25c, ¼ lb. 75c.

Early Prolific, or Orange Marrow. The earliest and most productive fall and winter Squash; color bright orange, flesh dry and sweet. Pkt. 10c, oz. 25c, ¼ lb. 75c.

Early Giant Summer Crookneck. Very early variety; long shape and of a bright yellow color. Pkt. 10c, oz. 25c, ¼ lb. 75c, lb. \$2.00.

Essex Hybrid Turban. Productive, with very hard shell; a solid, heavy, thick-fleshed sort of excellent flavor. Pkt. 10c, oz. 25c, ¼ lb. 75c.

Giant Straightneck Summer. Despite its large size the flesh is rich and fine flavored. Its attractive appearance has made it popular with the market gardeners. Pkt. 10c, oz. 25c, ¼ lb. 75c, lb. \$2.50.

Golden Delicious. In shape, size, and season it is practically the same as the original Delicious. Its deep orange colored shell and thick dry orange flesh of superb flavor and texture. Pkt. 10c, oz. 25c, ¼ lb. 75c.

Hubbard. Standard winter Squash. Color green, shell extremely hard; flesh dry, fine grained and sweet; excellent keeper. Pkt. 10c, oz. 25c, ¼ lb. 75c, lb. \$2.50.

Hubbard Mammoth Warty. A superior strain of mammoth size. Rich, dark green color and of very best quality. Pkt. 10c; oz. 25c, ¼ lb. 75c, lb. \$2.50.

Hubbard, Golden. Earlier than Hubbard; color a rich orange-red; hard and warty. Pkt. 10c, oz. 25c, ¼ lb. 75c, lb. \$2.50.

Hubbard, Symmes Blue. A superior strain, thick meated, fine grained, dry and very sweet. A heavy cropper and good keeper. Pkt. 10c, oz. 35c, ¼ lb. \$1.00.

The Warren. Resembles the Essex Hybrid but has a shell generally harder and thicker. The color is of a richer and deeper orange. The flesh is of excellent quality. Pkt. 10c, oz. 35c, ¼ lb. \$1.00.

Vegetable Marrow, English. Grows about 9 inches long. Pale straw colored, changing to a deeper shade. Flesh white. Pkt. 10c, oz. 25c, ¼ lb. 75c.

Vegetable Marrow, Italian (Cocozelle di Napoli). Skin smooth, mottled, dark and light green. Grows from 12 to 20 inches long. Flesh delicate green; quality fine. Pkt. 10c, oz. 25c, ¼ lb. 75c.

Vegetable Spaghetti. The fruit of this variety is creamy white, about 8 inches long and 4 to 5 inches in diameter. When mature, boil whole for twenty to thirty minutes, cut open, remove the center, seed core, and season the flesh with butter and salt. This is a most delicious and tasty vegetable. Pkt. 10c, oz. 25c, ¼ lb. 75c.

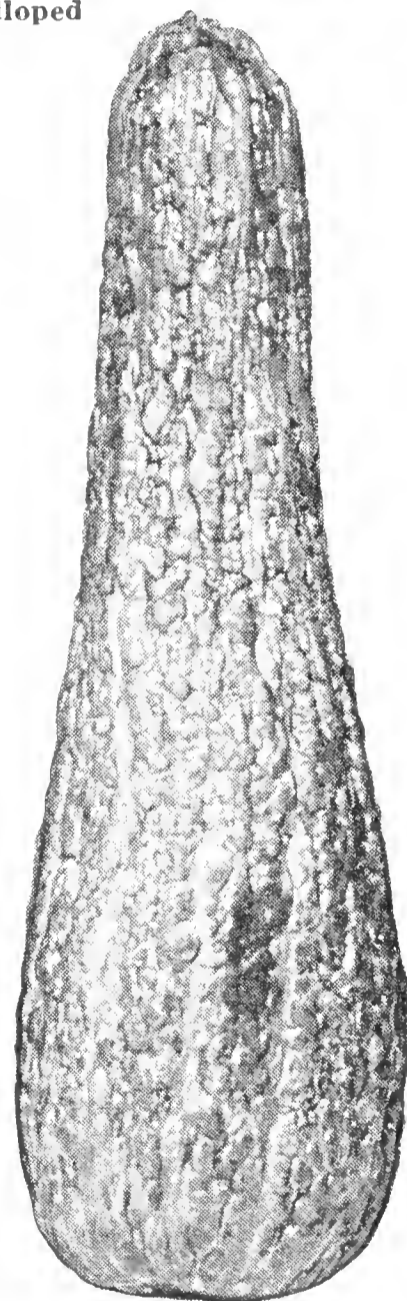

Giant Summer Straightneck

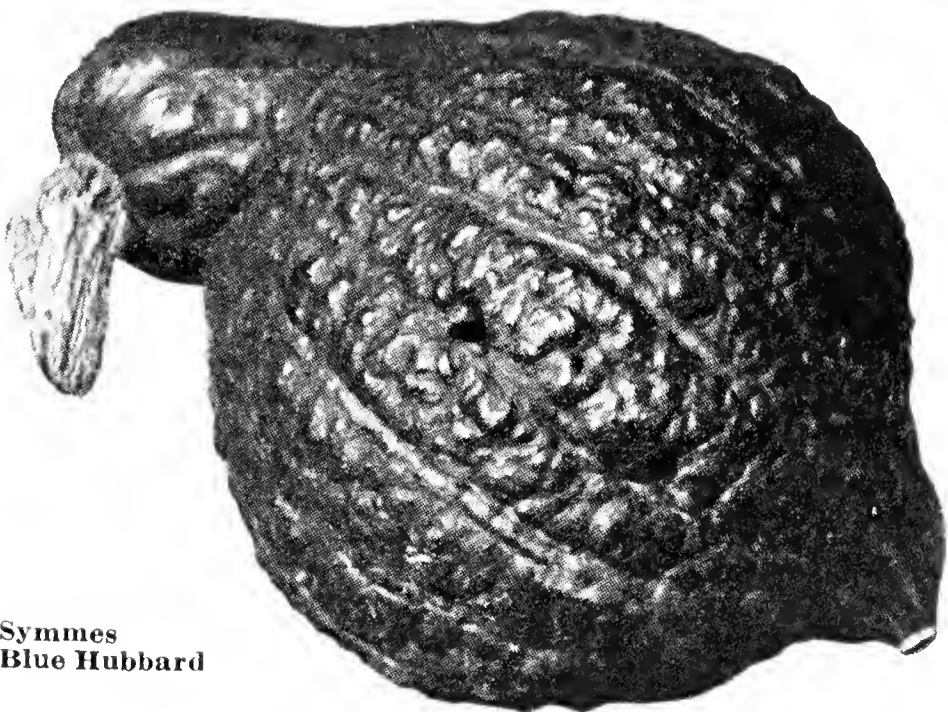

Symmes Blue Hubbard

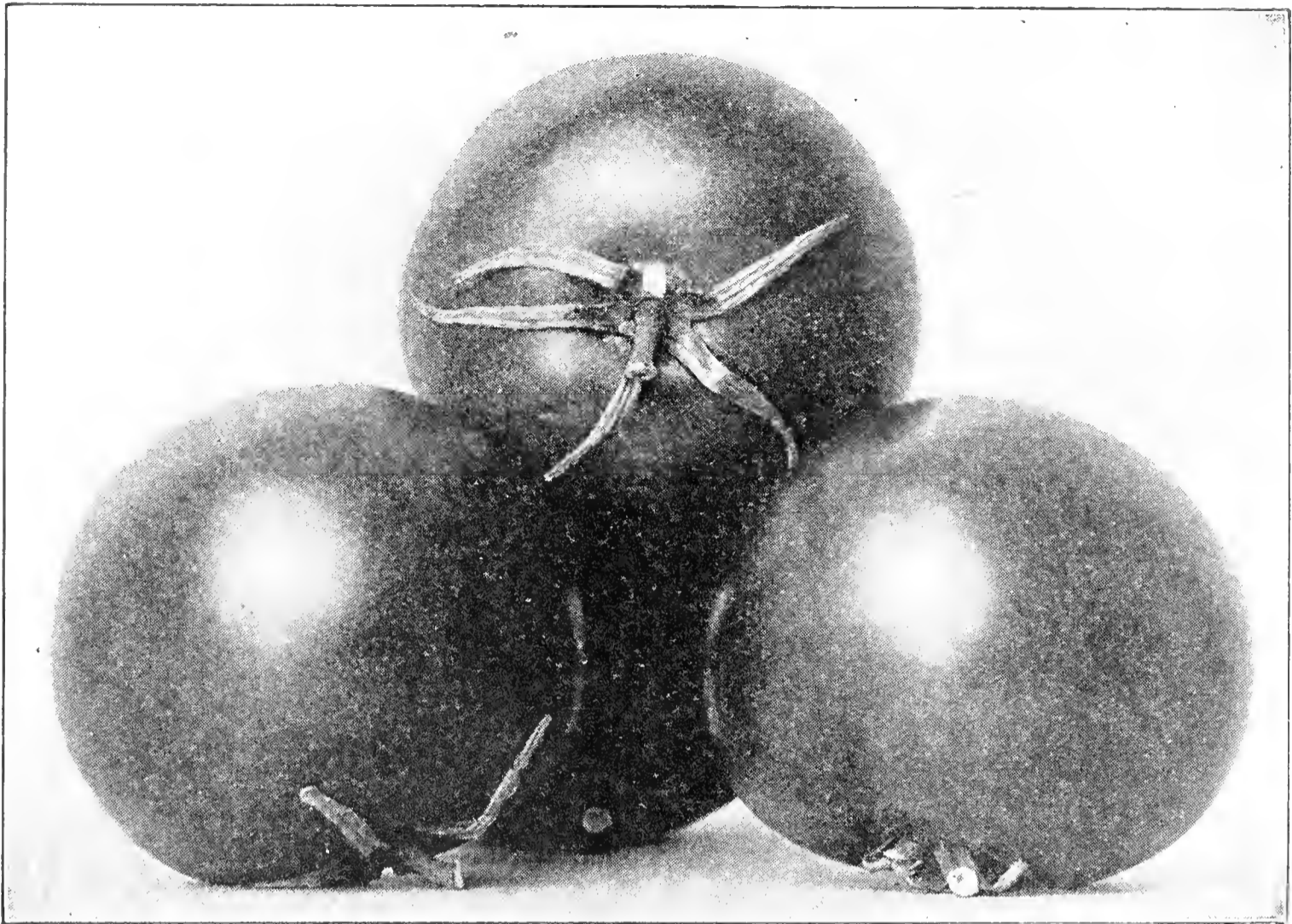

Tomato, Lister's Prolific

Tomato

One ounce will produce 1500 plants.

Sow seed in a hotbed the first week in March, in drills 5 inches apart. When the plants are about 2 inches high they should be set out 4 or 5 inches apart in another hotbed, or removed into small pots, allowing a single plant to a pot. About the middle of May the plants may be set

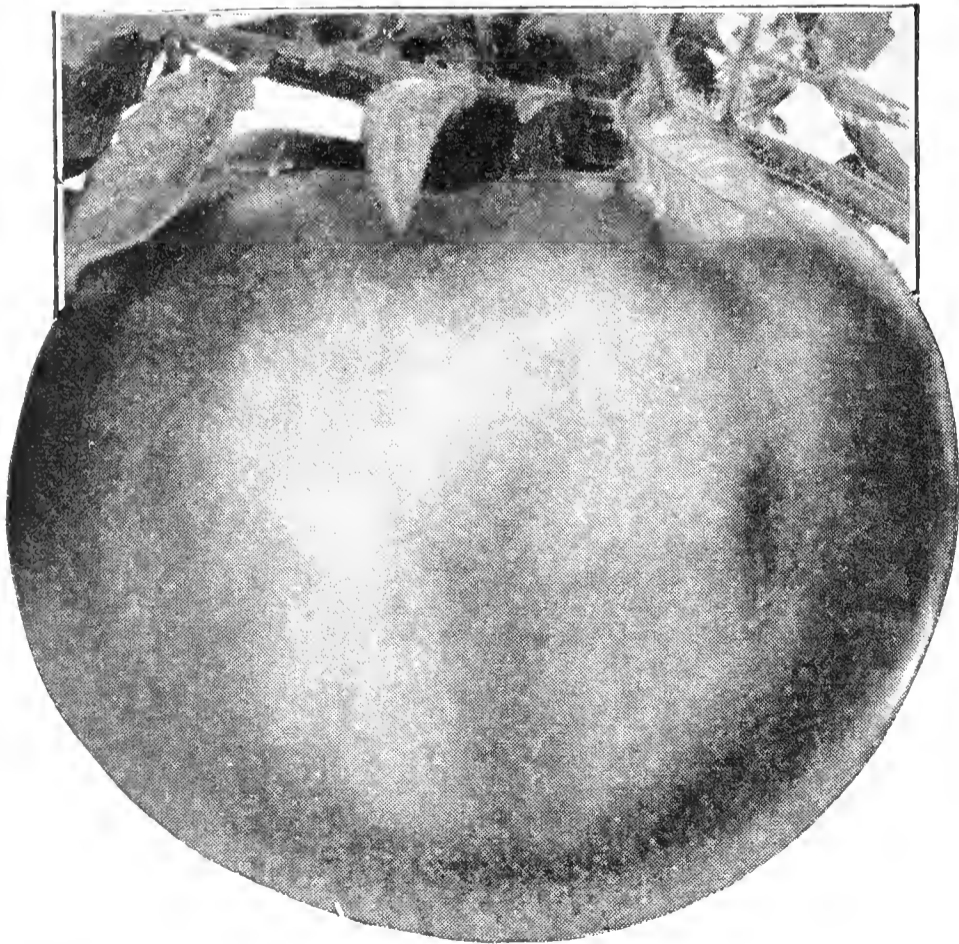

John Baer Tomato

out in the open ground; they are planted for early crops on light, sandy soil, at a distance of 3 feet apart.

Ailsa Craig. One of the best forcing varieties, also does well outdoors; a heavy cropper. Fruit medium size, smooth and of a rich scarlet color. Pkt. 25c.

Belmont, Improved. An excellent scarlet variety. Early. Medium, size; solid and smooth. Pkt. 10c, oz. 40c, $\frac{1}{4}$ lb. \$1.25.

Best of All, Sutton's. A good forcing or outdoor variety; deep scarlet; solid. Pkt. 25c, oz. \$1.00.

Bonny Best. Early, productive. Smooth, solid and uniform in size; scarlet. Pkt. 10c, oz. 40c, $\frac{1}{4}$ lb. \$1.25.

Break o' Day. An early Tomato of the Marglobe type, fruit of good size, color scarlet; smooth and of good quality. Pkt. 10c, oz. 50c, $\frac{1}{4}$ lb. \$1.75.

Carter's Sunrise (True Stock). One of the best Tomatoes for indoor or outdoor cultivation. Perfect in shape, of good size and free cropper; the fruit is bright red. Pkt. 25c, oz. \$1.00.

Chalk's Early Jewel. Large, solid, smooth, bright red variety. Pkt. 10c, oz. 40c, $\frac{1}{4}$ lb. \$1.25.

Comet. One of the best for forcing; brilliant scarlet color, medium size, smooth and solid. Pkt. 10c, oz. 75c, $\frac{1}{4}$ lb. \$2.25.

Dwarf Champion. Of compact, upright growth. Fruit solid, smooth, purplish red. Pkt. 10c, oz. 40c, $\frac{1}{4}$ lb. \$1.25.

Dwarf Stone. Resembles Dwarf Champion; fruit larger and more prolific; fine color. Pkt. 10c, oz. 40c, $\frac{1}{4}$ lb. \$1.25.

Earliana. The earliest red Tomato. Very smooth; fine for market. Pkt. 10c, oz. 40c, $\frac{1}{4}$ lb. \$1.25.

Golden Ponderosa. A large golden yellow variety of excellent quality. Pkt. 10c, oz. 50c, $\frac{1}{4}$ lb. \$1.50.

Golden Queen. The best yellow variety, medium size, smooth and solid. Pkt. 10c, oz. 50c, $\frac{1}{4}$ lb. \$1.50.

Globe, Livingston's. Very early; large, smooth variety. Pkt. 10c, oz. 40c, $\frac{1}{4}$ lb. \$1.25.

Tomatoes—Continued

- John Baer.** An early bright scarlet new Tomato. Large and fleshy. Pkt. 10c, oz. 40c, ¼ lb. \$1.25.
- Lister's Excelsior.** One of the best for forcing or outdoor culture; a heavy cropper of good flavor and color. Original pkt. 50c.
- Lister's Prolific.** This variety planted out or grown in a greenhouse has proved a remarkably valuable variety. Pkt. 50c.
- Lister's Protection.** The best of Lister's productions. Color dark crimson, a heavy cropper, perfect in shape and size. Pkt. 75c.
- Marglobe.** A midseason variety entirely immune from rust, pure scarlet, globe-shaped. Good size, heavy cropper and fine quality. Pkt. 10c, oz. 40c.
- Matchless.** Very large, solid, meaty, brilliant red fruits. Pkt. 10c, oz. 50c, ¼ lb. \$1.50.

SMALL FRUITED VARIETIES

- Red Cherry.** Valuable for preserving. Pkt. 10c, oz. 50c, ¼ lb. \$1.50.
- Red Currant.** Very small. Used in preserves. Pkt. 10c, oz. 50c, ¼ lb. \$1.50.
- Red Peach.** A small pink-fruited variety. Pkt. 10c, oz. 50c, ¼ lb. \$1.50.
- Red Pear.** Solid, handsome fruit. Good preserving variety. Pkt. 10c, oz. 50c, ¼ lb. \$1.50.
- Red Plum.** Valuable for salads. Pkt. 10c, oz. 50c, ¼ lb. \$1.50.
- Strawberry Tomato or Winter Cherry.** Fruit grows in a husk and will keep all winter. Pkt. 10c, oz. 50c, ¼ lb. \$1.50.
- Yellow Cherry.** Same as Red Cherry except for color. Pkt. 10c, oz. 50c, ¼ lb. \$1.50.
- Yellow Peach.** Fruits have a beautiful Peach appearance. Pkt. 10c, oz. 50c, ¼ lb. \$1.50.
- Yellow Pear.** Fruits set in large cluster. Pkt. 10c, oz. 50c, ¼ lb. \$1.50.
- Yellow Plum.** Valuable for salads and pickling. Pkt. 10c, oz. 50c, ¼ lb. \$1.50.

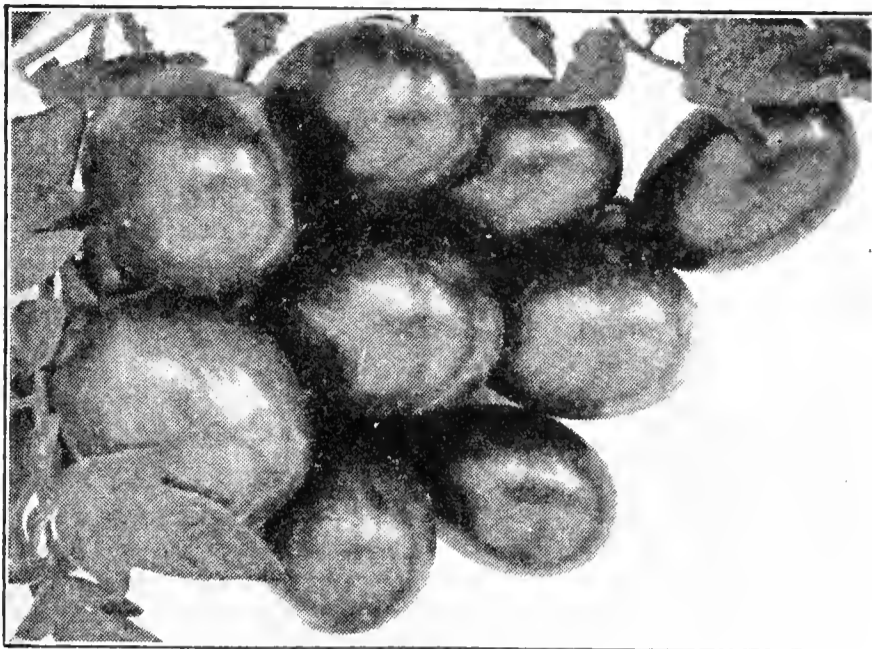

Plum Shaped Yellow Tomato

- Penn State.** An early variety, color rich scarlet, flesh dark red, quality and flavor of the finest. Pkt. 10c, oz. \$1.75, ¼ lb. \$6.00.
- Ponderosa.** Very large, solid and of excellent flavor. Pkt. 10c, oz. 40c, ¼ lb. \$1.25.
- Pritchard (Scarlet Topper).** A midseason wilt-resistant variety. Fruit large, globe-shaped, smooth; color deep scarlet. Of excellent quality and fine flavor. Pkt. 10c, oz. 50c, ¼ lb. 1.50.
- Scott's Ellenbank.** A very large cropper, carrying trusses from 3 to 4 lbs. One of the best Tomatoes for indoor or outdoor cultivation. Pkt. 75c.
- Stirling Castle.** This is one of the best for indoor culture. Round, smooth, delicious flavor. Pkt. 25c, ¼ oz. \$1.00, oz. \$3.00.
- Stone, Livingston's.** Large, bright scarlet, solid, smooth, later than many, very productive. Pkt. 10c, oz. 40c, ¼ lb. \$1.25.

Turnip

One ounce will sow 150 feet of drill; 1½ lbs. per acre.

Turnips do best in highly enriched, light, sandy or gravelly soil; sow the earliest varieties as soon as the ground can be worked in the spring, in drills 12 to 18 inches apart. Seed can also be sown broadcast, using 3 pounds to the acre for fall and winter use. Swedish or Rutabaga Turnips are largely grown for a farm crop, as well as for the table; make sowings from the 10th of June until the last of July, in drills 2 to 3 feet apart.



Purple Top Strap Leaf Turnip

- Extra Early Milan, White.** A beautiful early variety with small tops, tender and sweet. Pkt. 10c, oz. 20c, ¼ lb. 60c.
- Golden Ball.** Bulb of fine form and bright yellow color, a fine keeper; unsurpassed for table use. Pkt. 10c, oz. 20c, ¼ lb. 60c, lb. \$1.50.
- Milan Early, Purple Top.** The earliest of the white flesh varieties. Pkt. 10c, oz. 25c, ¼ lb. 75c.
- Purple Top Strap Leaf.** A well known variety, extensively grown both for table and for stock. Pkt. 10c, oz. 15c, ¼ lb. 30c, lb. 90c.
- Purple Top White Globe.** A handsome, globe shaped variety, valuable for market purposes. Pkt. 10c, oz. 20c, ¼ lb. 50c, lb. \$1.25.
- White Egg.** Oval shaped variety for spring or fall sowing; flesh white, firm, fine-grained, mild and sweet. Pkt. 10c, oz. 20c, ¼ lb. 50c, lb. \$1.25.
- Yellow Aberdeen.** Hardy, productive and a good keeper; yellow, flesh firm, good for table use or feeding stock. Pkt. 10c, oz. 20c, ¼ lb. 60c, lb. \$1.50.

Rutabaga or Swedish Turnip

- Budlong Swede.** A choice strain nearly round in form. Sweet, of excellent flavor and keeps well. Pkt. 10c, oz. 15c, ¼ lb. 40c, lb. \$1.00.
- Carter's Imperial.** An excellent sort, for either table use or feeding stock. Flesh yellow, solid, firm, sweet and rich. Pkt. 10c, oz. 25c, ¼ lb. 75c, lb. \$2.00.
- Improved American, Purple Top.** A yellow-fleshed, purple top variety grown for stock or table. Pkt. 10c, oz. 15c, ¼ lb. 40c, lb. \$1.00.
- Monarch.** A deep yellow fleshed, purple top variety, smooth, oval form, slightly tapering at ends; small neck and fine for table use. Pkt. 10c, oz. 15c, ¼ lb. 40c, lb. \$1.00.
- Shamrock.** An excellent variety; desirable either for stock or table use. Pkt. 10c, oz. 15c, ¼ lb. 40c, lb. \$1.00.
- White French.** Oval in form, clear white flesh; one of the best winter Turnips. Pkt. 10c, oz. 15c, ¼ lb. 40c, lb. \$1.00.
- Macomber.** The flesh is white, fine grained and of a mild sweet flavor. They will keep all winter and remain in fine condition for the table if properly stored. Pkt. 10c, oz. 25c, ¼ lb. 75c.

Pot, Sweet, and Medicinal Herbs

Plant in the spring when the ground is warm, in drills, covering lightly. When the plants are well up, thin out or transplant to about 4 inches apart. They should be harvested on a day just before the blossom develops, dried quickly and bottled, or closely packed in dry boxes with the air entirely excluded.

Anise (*Pimpinella anisum*). Annual. Used for flavoring and garnishing. Pkt. 10c, oz. 30c.

Arnica (*Arnica montana*). Perennial. Used in medicine as a narcotic and stimulant. Pkt. 10c, oz. \$2.00.

Balm (*Melissa officinalis*). Perennial. Leaves have a fragrant odor and are used medicinally. Pkt. 10c, oz. \$1.00.

Basil, Sweet (*Ocimum basilicum*). Annual. Used for flavoring soups, stews, etc. Pkt. 10c, oz. 30c.

Borage (*Borago officinalis*). Annual. Leaves are used for flavoring and bees are attracted by the flowers. Pkt. 10c, oz. 40c.

Caraway (*Carum carui*). Perennial. Used for flavoring confectionery, bread, etc. Pkt. 10c, oz. 30c.

Catnip (*Nepeta cataria*). Perennial. Sometimes used in medicine. Pkt. 10c.

Coriander (*Coriandrum sativum*). Annual. Used in the manufacture of confectionery and liquors. Pkt. 10c, oz. 30c.

Dill (*Anethum graveolens*). Biennial. The seeds are aromatic and pungent. Used in pickling cucumbers. Pkt. 10c, oz. 50c.

Fennel, Sweet (*Anethum foeniculum*). Perennial. Leaves when boiled are used in sauces. Pkt. 10c, oz. 50c.

Fennel, Florence (*Anethum foeniculum*). The roots are boiled, also used as salad. Pkt. 10c, oz. 50c.

Horehound (*Marrubium vulgare*). Perennial. Used medicinally, also for seasoning. Pkt. 10c, oz. 50c.

Hyssop (*Hyssopus officinalis*). Perennial. Used medicinally. The leaves have a pungent taste. Pkt. 10c, oz. 60c.

Lavender (*Lavandula vera*). Perennial. Yields an oil used in medicine and perfumery. Pkt. 10c, oz. \$1.00.

Loveage (*Levisticum officinale*). Perennial. An aromatic stimulant used in medicine. Pkt. 10c, oz. \$1.00.

Marjoram, Sweet (*Origanum majorana*). Annual. Aromatic and fragrant. Much used in flavoring. Pkt. 10c, oz. 80c.

Pennyroyal (*Hedeoma pulegioides*). Annual. An aromatic medicinal herb. Pkt. 10c, oz. \$1.00.

Rosemary (*Rosmarinus officinalis*). Perennial. Leaves fragrant, with warm, pungent, bitterish taste. Pkt. 10c.

Rue (*Ruta graveolens*). Perennial. Has a strong, heavy odor and bitter taste. Used medicinally. Pkt. 10c, oz. \$1.25.

Saffron (*Carthamus tinctorius*). Annual. Flowers are used as a dyestuff and in making rouge. Pkt. 10c.

Sage (*Salvia officinalis*). Perennial. More used than any other herb for dressings and seasoning. Pkt. 10c, oz. 50c.

Sorrel (*Rumex crispus*). Perennial. Used for salads or cooked and served as Spinach. Pkt. 10c, oz. 50c.

Summer Savory (*Satureia hortensis*). Annual. Used for flavoring soups and dressings. Pkt. 10c, oz. 25c.

Thyme (*Thymus vulgaris*). Perennial. Used for seasoning. Also used medicinally. Pkt. 10c, oz. \$1.25.

Wormwood (*Artemisia absinthium*). Perennial. Used medicinally and is beneficial for poultry. Pkt. 10c.

PLANTS OF HERBS—To meet the increasing demand for plants of the most popular herbs, we can supply 3 plants for \$1.25, 10 for \$3.50. Not less than 3 of one variety sold.

Vegetable Roots and Plants

We do not send Vegetable Plants by mail except where noted.

ASPARAGUS, Selected Roots.	100	1000
Martha Washington	\$2.00	\$18.00
Mary Washington	2.25	20.00
ARTICHOKE, Jerusalem, Qt. 40c, by mail 10c additional; pk. \$2.50.		
ARTICHOKE PLANTS, Green Globe, May delivery.	Doz.	100
	\$2.50.	
BRUSSELS SPROUTS PLANTS	\$0.30	\$1.50
CABBAGE PLANTS:		
Early Jersey Wakefield30	1.50
Globe Curled Savoy30	1.50
Henderson's Summer30	1.50
Stone Mason30	1.50
CAULIFLOWER PLANTS:		
Earliest Erfurt30	2.00
Early Snowball30	2.00
CELERY PLANTS.		
Boston Market25	1.25
Golden Self Blanching25	1.25
Giant Pascal25	1.25

CHIVES, Roots. 30c per clump, 12 clumps, \$3.00. By mail, add 10c extra for each clump.

EGGPLANT	Doz.	100
Black Pekin	\$1.00	\$7.00
New York Improved	1.00	7.00
HORSERADISH Sets or cuttings35	1.75
LETTUCE PLANTS25	1.25
MINT ROOTS	25c each..	2.50 18.00
PEPPER PLANTS50	3.00
RHUBARB ROOTS.	Each	Doz.
Victoria, Largest variety35	3.00
Clumps75	
TARRAGON PLANTS (Estragon)50	5.00
TOMATO PLANTS (Pot-grown)	Doz.	100
Bonny Best	\$1.00	\$7.00
Dwarf Champion	1.00	7.00
Dwarf Stone	1.00	7.00
John Baer	1.00	7.00
Stone, Livingston's	1.00	7.00

Tobacco

Connecticut Seed-leaf. Suited to the climate of the Northern and Middle States. Pkt. 10c, oz. 75c.

Havana, Imported Seed. Pkt. 10c, oz. 75c.

Free Delivery

IN GREATER BOSTON we deliver, Free of Charge, all merchandise purchased at retail catalog prices at our option.

Special Notice

We do not send Vegetable Plants, such as Cabbage, Cauliflower, Eggplant, Parsley, Pepper and Tomato Plants, via Parcel Post. The foliage of these plants is very soft and tender and (largely) because of delays in the mail they reach their destination in a worthless condition. We do not ship plants or other perishable goods C. O. D. Customer pays express or freight charges on Roots and Plants.



Grey's Special Lawn Grass Seed Mixtures

The following directions may be useful to those who are not familiar with lawn making.

The soil should be of good depth, moderately rich, the land should be carefully drained, and the soil thoroughly pulverized. Some good fertilizer—pure ground bone, wood ashes, or a specially prepared lawn fertilizer—should be used. After sowing, the ground should be lightly raked and rolled.

The selection of seed is important. Use only such mixtures as are free from weed seeds, and such as will produce a firm, strong turf and a fine growth. A liberal quantity is necessary to secure good results (not less than 64 pounds per acre). The best time to make a lawn is from the middle of August through September. If seed is sown at this season, the grass will become strong enough to withstand the winter, and a good lawn is assured the following season.

Grey's Special Recleaned Lawn Grass Seed

In recommending this grade to our customers we are recommending a mixture which cannot be excelled for general lawn purposes. Weight 32 lbs. per bu. Sow 64 lbs. per acre. Per lb. 60c, per 100 lbs. \$45.00.

GREY'S SPECIAL BENT GRASS MIXTURE. A combination of Bent grasses and red top which will produce a turf much finer in texture than a lawn of the ordinary type. Per lb. \$1.00, per 100 lbs. \$85.00.

GREY'S GRASS MIXTURE FOR SHADED LAWNS. Fine grasses selected especially for locations partially shaded by buildings or trees. Weight 24 lbs. per bu. Per lb. 65c, per 100 lbs. \$60.00.

GREY'S BANK AND TERRACE GRASS MIXTURE. This mixture is composed of deep rooting varieties which will give satisfactory results on steep inclines or terraces. Per lb. 55c, per 100 lbs. \$45.00.

GREY'S NO. 2 LAWN GRASS MIXTURE. To meet the requirements of those desiring a moderate-priced lawn seed, and suitable for various soils. This mixture is composed of such varieties as to produce a permanent, heavy turf. Weight 20 lbs. per bu. Per lb. 45c, per 100 lbs. \$35.00.

Our aim is purity, quality and service. We are pleased at all times to quote prices on special grass mixtures, and for those wishing mixtures of their own formula, we will either ship the varieties separate, or mix them to the customer's instruction.

Special Mixtures for Tennis Courts, Golf Links, etc.

The following mixtures used on many prominent golf courses, etc., in this vicinity, have given entire satisfaction.

Fair Green Mixture. For general use on golf links. Per lb. 60c, 100 lbs. \$50.00.

Putting Green Mixture. A combination of grasses best suited to produce a close, firm and lasting turf which will endure frequent cutting. Per lb. 75c, 100 lbs. \$65.00.

Tennis Court Mixture. A mixture of fine grasses especially adapted to tennis courts, which will bear trampling without injury. Per lb. 60c, 100 lbs. \$50.00.

Ball Grounds Mixture. This mixture is used by both the Leagues in Boston with the most satisfactory results. Per lb. 45c, 100 lbs. \$35.00.

Bowling Green Mixture. Mixture of fine, hardy grasses, especially adapted for bowling greens. Lb. 60c, 100 lbs. \$50.00.

Seashore Lawn Grass Mixture. A mixture of fine grasses selected for their deep rooting qualities. Per lb. 60c, 100 lbs. \$50.00.

PRICES SUBJECT TO CHANGE WITHOUT NOTICE.



Choice Grass Seeds

All strictly Recleaned and Carefully Tested for Purity and Germination.

All grasses sold f.o.b. Boston. Bags extra. Prices subject to market changes. Samples sent on request.

Many growers of grass seeds offer several grades of each variety, varying greatly in price. We do not recommend nor do we sell the inferior grades. Those which we offer are strictly **high grade**, and the prices at which we offer them should not be compared with those quoted for inferior grades.

Free Delivery. We will prepay Parcel Post charges on cash orders at quoted catalogue prices on Grass Seeds, up to two pounds, anywhere in the United States, east of the Mississippi River; for larger quantities, the purchaser pays transportation charges.

Chewing's New Zealand Fescue. A splendid grass of creeping habit, forming a close and lasting turf. An excellent grass for golf courses. Lb. 50c, 100 lbs. \$45.00.

Crested Dogtail (*Cynosurus cristatus*). Good for permanent pasture; is productive and early. 35 lbs. to the acre. Lb. 55c, 100 lbs. \$50.00.

Fine-Leaved Fescue (*Festuca tenuifolia*). Its dwarf habit and fineness of leaf render it suitable for dry slopes on lawn. Weight 22 lbs. per bu. Lb. \$1.25, 100 lbs. \$115.00.

Italian Rye Grass (*Lolium italicum*). Valuable for mixing with other pasture grasses; sow 50 lbs. to the acre. Lb. 20c, 100 lbs. \$15.00.

Kentucky Blue (*Poa pratensis*). For pasture and lawns it has no superior; although slow to establish itself, once a stand is had, its creeping roots will form a close and lasting turf; usually sown with other grasses. Weight 14 lbs. per bu. Lb. 40c, 100 lbs. \$35.00.

Meadow Fescue (*Festuca pratensis*). One of the best grasses for permanent pasture. Sow 40 lbs. per acre. Lb. 25c, 100 lbs. \$20.00.

Meadow Foxtail (*Alopecurus pratensis*). One of the best and earliest of pasture grasses. 30 lbs. to the acre. Lb. 60c, 100 lbs. \$55.00.

Orchard (*Dactylis glomerata*). One of the earliest grasses; and is excellent for pasture or hay. Sow 40 lbs. per acre. Lb. 25c, 100 lbs. \$20.00.

Perennial Rye Grass (*Lolium perenne*). Valuable where mixed with other grasses for lawns golf links, etc. Lb. 25c, 100 lbs. \$20.00.

Red Top (*Agrostis vulgaris*). Invaluable for lawn seed mixture.

Unhulled Seed. 10 lbs. per bu. Lb. 18c, 100 lbs. \$15.00.

Fancy Recleaned Seed. Absolutely clean and free from chaff. 36 lbs. per bu. Lb. 35c, 100 lbs. \$30.00.

Red, or Creeping Fescue (*Festuca rubra*). A creeping rooted grass forming a close and lasting turf. Lb. \$1.00, 100 lbs. \$95.00.

Rough Stalked Meadow Grass (*Poa trivialis*). It thrives on moist, rich soils and in sheltered situations. Lb. 50c, 100 lbs. \$45.00.

Sheep's Fescue (*Festuca ovina*). This is especially valuable as it thrives on poor, light or gravelly soils. 16 lbs. per bu. Lb. 50c, 100 lbs. \$45.00.

Sweet Vernal, True Perennial (*Anthoxanthum odoratum*). Useful to mix with other grasses, and the fragrant odor which it imparts when drying. Lb., \$1.50.

Tall Fescue (*Festuca elatior*). Succeeds best on moist, alluvial and strong, clayey soils. Lb. 45c.

Tall Meadow Oat Grass (*Avena elatior*). This grass produces an abundant supply of foliage, and is valuable for pasture. Lb. \$1.50.

Timothy, "Herd's Grass" (*Phleum pratense*). It is generally sown with Red Top and Red Clover, and makes the most valuable hay. 45 lbs. per bu. Lb. 15c, 100 lbs. \$10.00.

Wood Meadow (*Poa nemoralis*). A variety specially suited for the shaded portions of lawns. The creeping roots make a strong firm sod. Lb. \$1.50, 100 lbs. \$125.00.

NOTICE. We are pleased at all times to quote prices on special grass mixtures, and for those wishing mixtures of their own formula, we will either ship the varieties separate, or mix them to the customer's instruction.

All prices subject to change without notice.

Bent Grasses for Lawns and Putting Greens

The various Bent Grasses have come into wide use for lawns and putting greens as they thrive in nearly all soils and produce a low, velvety sward of handsome, velvety texture.

Colonial Bent. A fine, hardy, very compact grass; very permanent, readily forming a heavy sward. Per lb. \$1.50.

Creeping Bent (*Agrostis stolonifera*). One of the most valuable lawn grasses because of its short growth and deep green, fine-leaved foliage. Its stoloniferous roots form a strong, close, enduring turf, which is not injured by being frequently walked on. Per lb. \$2.00.

German Mixed Bent (*European agrostis*). Makes beautiful thick velvety putting greens and lawns. Per lb. \$1.00.

Rhode Island Bent. Resembles Red Top but is of dwarfer habit. A fine, hardy, very compact grass; excellent for lawns. Sow 4 bus. per acre if alone. 14 lbs. per bu. Per lb. \$1.00.

Seaside Bent or Cocoos Bent (*Agrostis stolonifera compacta; agrostis maritima*). A creeping variety valuable for lawns and putting greens, producing a velvety turf of beautiful texture. Per lb. \$1.00.

Velvet Bent (*Agrostis canina*). A variety which is ideal for the finest lawns. This is the dwarfest of the turf grasses. Per lb. \$5.00.



Special Mixtures

For Permanent Hay

Sow 50 pounds to acre. 100 lbs.

No. 1 for Cool Moist Soils	\$30.00
No. 2 for High Dry Soils	30.00
No. 3 for Wet Soils	30.00

For Permanent Pastures

Sow 50 pounds to an acre. 100 lbs.

No. 4 for Cool, Moist Soils	\$35.00
No. 5 for High, Dry Soils	35.00
No. 6 for Wet Soils	35.00

Before Planting Clover Inoculate Seed with

Clover Seeds

Prices subject to change with the market.

<p>The Original Legume Inoculator NODDE-WILNER PROCESS NITRAGIN TRADE MARK REGD DEC 8 1926 NO 1272 Restores and Maintains Soil Fertility</p>																					
<p>INOCULATOR PRICES</p> <p>When Ordering, Always Specify Name of Seed</p>																					
<p>Alfalfa, all Clovers</p> <table border="0"> <tr> <td>Size</td> <td>Retail</td> </tr> <tr> <td>1/2 bu. ea.</td> <td>\$.35</td> </tr> <tr> <td>1 bu. ea.</td> <td>.55</td> </tr> <tr> <td>2 1/2 bu. ea.</td> <td>1.20</td> </tr> </table>		Size	Retail	1/2 bu. ea.	\$.35	1 bu. ea.55	2 1/2 bu. ea.	1.20												
Size	Retail																				
1/2 bu. ea.	\$.35																				
1 bu. ea.55																				
2 1/2 bu. ea.	1.20																				
<p>Vetch, Austrian Peas, Canadian Peas, Beans</p> <table border="0"> <tr> <td>Size</td> <td>Retail</td> </tr> <tr> <td>1/2 bu. ea.</td> <td>\$.30</td> </tr> <tr> <td>1 bu. ea.</td> <td>.45</td> </tr> <tr> <td>* 1 1/3 bu. ea.</td> <td>.65</td> </tr> <tr> <td>5 bu. ea.</td> <td>1.85</td> </tr> <tr> <td>*12 1/2 bu. ea.</td> <td>4.25</td> </tr> </table> <p>*"100 lb. size." Packed only for Vetch and Peas.</p>		Size	Retail	1/2 bu. ea.	\$.30	1 bu. ea.45	* 1 1/3 bu. ea.65	5 bu. ea.	1.85	*12 1/2 bu. ea.	4.25								
Size	Retail																				
1/2 bu. ea.	\$.30																				
1 bu. ea.45																				
* 1 1/3 bu. ea.65																				
5 bu. ea.	1.85																				
*12 1/2 bu. ea.	4.25																				
<p>LESPEDEZA Unhulled or Hulled</p> <table border="0"> <tr> <td>Size</td> <td>Retail</td> </tr> <tr> <td>1 bu. ea.</td> <td>\$.35</td> </tr> <tr> <td>2 bu. ea.</td> <td>.55</td> </tr> <tr> <td>5 bu. ea.</td> <td>1.20</td> </tr> </table> <p>Peanuts, Soy Beans, Cow Peas, Lima Beans</p> <table border="0"> <tr> <td>Size</td> <td>Retail</td> </tr> <tr> <td>1 bu. ea.</td> <td>\$.35</td> </tr> <tr> <td>2 bu. ea.</td> <td>.55</td> </tr> <tr> <td>5 bu. ea.</td> <td>1.20</td> </tr> <tr> <td>10 bu. ea.</td> <td>1.75</td> </tr> <tr> <td>*25 bu. ea.</td> <td>3.75</td> </tr> </table> <p>*"25 bu. size." Packed only for Soy Beans, Cow Peas.</p>		Size	Retail	1 bu. ea.	\$.35	2 bu. ea.55	5 bu. ea.	1.20	Size	Retail	1 bu. ea.	\$.35	2 bu. ea.55	5 bu. ea.	1.20	10 bu. ea.	1.75	*25 bu. ea.	3.75
Size	Retail																				
1 bu. ea.	\$.35																				
2 bu. ea.55																				
5 bu. ea.	1.20																				
Size	Retail																				
1 bu. ea.	\$.35																				
2 bu. ea.55																				
5 bu. ea.	1.20																				
10 bu. ea.	1.75																				
*25 bu. ea.	3.75																				
<p>New Garden Size NITRAGIN for Garden Peas, Beans, Sweet Peas, Lima Beans and Lupines</p> <p>Each package will inoculate any amount up to 4 lbs. seed. Retail Price\$1.0 ea.</p>																					

Alfalfa, Genuine Grimm. It originated in northern Minnesota. The strong branching roots of Genuine Grimm Alfalfa prevent winter-killing. Sow 15 to 20 lbs. per acre. Lb. 45c, 100 lbs. \$40.00.

Alsike, or Swedish (*Trifolium hybridum*). Hardest of all the Clovers, and on rich, moist soil yields an enormous quantity of hay or pasturage. Valuable for sowing with Clovers or grasses, as it forms a thick bottom and increases yield of hay. Lb. 45c, 100 lbs. \$40.00.

Bokhara Clover (*Melilotus alba*). Valuable sort for soiling and for ensilage and bees. Grows from 3 to 5 feet high; sown in rich soil, may be cut three times; lasts for years if cut before flowering. 15 lbs. to the acre. Lb. 20c, 100 lbs. \$15.00.

Crimson Clover (*Trifolium incarnatum*). Sow in April or May; 20 lbs. to the acre. Not always hardy in New England. Lb., 20c, 100 lbs. \$15.00.

Red Clover, Medium (*Trifolium pratense*). The leading variety of Clover for pastures or meadows. Requires deep rich soil. Sow in spring. Lb. 45c, 100 lbs. \$40.00.

Red Clover, Mammoth. Grows 4 to 5 ft. high, and is used to plow under for manure. Lb. 45c, 100 lbs. \$42.00.

White Dutch Clover (*Trifolium repens*). The best variety for lawns, as it forms a close herbage and remains green throughout the season; valuable when mixed with grass seeds for pasture Lb. 50c, 100 lbs. \$40.00.

BIRD SEEDS

(Prices subject to market fluctuations)

	Lb.	100 lbs.		Lb.	100 lbs.
Blue Maw, or Poppy	\$0.35	\$30.00	Millet, Golden	\$0.10	\$ 8.00
Canary Seed, Choice Recleaned15	12.00	Millet, White French20	18.00
Hemp Seed, Recleaned Russian15	10.00	Wild Bird Food Mixture10	8.00
Rape, Bird15	10.00	Niger Seed40	35.00
Rape, English15	10.00	Cuttle Fish Bone50	45.00
Mixed Bird Seed. In bulk15	10.00	Sunflower Seed20	15.00
Lettuce for Birds30	20.00	Kaffir Corn10	5.00
Rice, Unhulled, or Paddy20	15.00	Vetch for Pigeons10	6.00
			Peas. Small white10	7.00

All prices subject to change without notice.

Farm and Field Seeds

All prices subject to market changes.

Barley

48 lbs. to the bushel; 2 bushels to the acre.

	Peck	Bushel
Four or six-rowed	\$1.00	\$3.00
Two-rowed	1.00	3.00

Before planting Beans,
inoculate seed with—



Beans

Sow 1 bushel to the acre.

Yellow Soja. A large-growing, yellow-seeded variety, especially suitable for ensilage and plowing under. Pk. \$1.25, bu. \$4.00.

Ito San. An early, small-leaved variety recommended for latitudes having short season, especially New England. Pk. \$1.25, bu. \$4.00.

Wilson. A rank-growing variety, branching high, leaves large, both pods and leaves remaining on vines long after cutting. Pk. \$1.25, bu. \$4.00.

Beets, Mangel Wurzel

Sow 6 to 8 pounds to acre.

Danish Sludstrup. A long, reddish yellow variety. Lb. 75c, 10 lbs. \$6.00.

Golden Tankard. An enormous yielder per acre. Flesh deep yellow. Lb. 75c, 10 lbs. \$6.00.

Mammoth Long Red. The largest and heaviest cropper of all the Mangels. Lb. 75c, 10 lbs. \$6.00.

Buckwheat

48 pounds to the bushel. Sow 1 bushel to the acre.

Japanese. Very prolific. Pk. \$1.00, bu. \$3.00.

Field Corn

Plant 8 to 12 quarts per acre in hills; for fodder or ensilage, in drills, 1 to 1½ bushels per acre; and for soiling, 3 to 4 bushels per acre, broadcast.

Flint Varieties

Early Canada. One of the earliest yellow varieties; ear small; in ordinary seasons the crop will be fully ripened in August. Pk. \$1.25, bu. \$4.00.

Longfellow. The standard variety in this section; long ears, small cob, bright yellow color, and medium early. Pk. \$1.25, bu. \$4.00.

Dent Varieties

Leaming. Yellow Dent variety, with large, deep grain of dark orange color; excellent for ensilage. Pk. 85c, bu. \$2.50.

Pennsylvania Sweepstake Corn. This variety of corn will mature quicker than any other variety. Pk. \$1.25, bu. \$4.00.

Pride of the North. The earliest Yellow Dent Corn in cultivation. Pk. \$1.00, bu. \$3.00.

Fodder and Ensilage Varieties

Eureka. Grows from 10 to 15 ft. high and produces a rich, heavy growth. Pk. \$1.00, bu. \$3.00.

Evergreen Sweet Fodder. For cutting green and feeding to stock this variety excels all others. Pk. \$1.75; bu. \$6.00.

Millet

German, or Golden. A valuable annual hay and fodder crop, more productive and coarser than the Hungarian. Sow 1 bushel to the acre. Pk. \$1.50, bu. \$5.00.

Japanese (Panicum Crus-galli). If sown early and cut, usually produces a good second crop. Sow 20 lbs. per acre. Lb. 10c, 100 lbs. \$8.00.

Hungarian Millet (Panicum germanicum). An annual forage plant, early and productive. Sow 1 bushel to the acre. Pk. \$1.50, bu. \$5.00.

Oats

Sow 2 to 3 bushels to the acre, 32 pounds to the bushel. **Canadian Cluster.** Heavy, with stiff straw; yields well. Pk. 50c, bu. \$1.50.

Welcome. A very productive white variety, with extra strong, straight, straw. Pk. 50c, bu. \$1.50.

Before planting Peas,
inoculate seed with—



Peas

Canada Field. Valuable when sown with Oats as a green fodder. Also makes good ensilage. Sow 2 bushels Oats and 1 bushel Peas per acre. Pk. \$1.50, bu. \$5.00.

Clay or Wonderful. Sow as early as May 10th or as late as July 1st, 1 bushel to the acre in drills; 2½ bushels to the acre broadcast. Pk. \$1.25, bu. \$4.00.

New Era. Early and large yielder. Pk. \$1.25, bu. \$4.00.

Whippoorwill. One of the earliest. Pk. \$1.25, bu. \$4.00.

Rape

50 pounds per bushel

Dwarf Essex. Fine for sheep pasture; valuable as a soil enricher. Plant in June or July in drills at the rate of 3 lbs. per acre, broadcast 5 lbs. per acre. Lb. 15c, 100 lbs. \$10.00.

Rye

Sow 1½ bushels per acre (56 lbs. per bu.).

Rosen Winter Rye. The most desirable variety for northeast conditions, either summer or autumn planting. Pk. 75c, bu. \$2.50.

Spring Rye. Selected re-cleaned grain in limited supply. Pk. 85c, bu. \$3.00.

Sorghum

Sow 25 pounds per acre in drills; for dry fodder, broadcast 100 pounds per acre.

Early Amber Sugar Cane. Will ripen where Indian corn matures. Lb. 25c, 100 lbs. \$20.00.

Red Kaffir Corn or Sorghum. Non-saccharine. The plants cure into excellent fodder, or may be fed green during all stages of growth. Lb. 20c, 100 lbs. \$12.00.

White Kaffir Corn. Lb. 20c, 100 lbs. \$12.00.

Sudan Grass

Sown broadcast use 16 to 24 pounds of seed per acre; if planted in drills, 18 to 24 inches apart, from 4 to 6 pounds per acre will be sufficient. Lb. 15c, 100 lbs. \$10.00.

Sunflower

Sow 6 to 8 pounds per acre (25 pounds per bushel).

Mammoth Russian. Very productive, large heads with large seeds. Valuable for poultry. Lb. 20c, 100 lbs. \$15.00.

Before planting Vetches,
inoculate seed with—



Vetches or Tares

Weight, 60 pounds per bushel.

Vetches or Tares, Spring (Vicia sativa). Frequently sown with oats. Sow 1-1½ bus. per acre. Pk. \$1.75, bu. \$6.00.

Vetches, Sand, Winter, or Hairy (Vicia villosa). Thrives on poor, arid, sandy soil, and can be sown either in spring or fall. Sow 40 to 50 pounds per acre. Pk. \$2.75, bu. \$10.00.

Wheat

Sow 1½ bushels per acre (60 pounds per bushel).

Spring (Marquis). Pk. \$1.00; bu. \$3.00.

Winter (Klondyke Bald). White grain. Pk. \$1.00; bu. \$3.00.

All Grains sold f. o. b. Boston. Bags extra. Prices subject to market changes. Samples sent on request.

Lilies

In the flower garden Lilies rank first in importance. They are stately and beautiful, matchless in form and variety of color, while possessing the most agreeable perfume, and for general effect they have no rivals. Plant 6 inches deep in a well-drained, deep, loamy soil made rich with thoroughly rotted manure, and an inch of clean sand placed under and over the bulbs when setting.

Auratum (Golden Rayed Lily of Japan). Large, pure white flowers, with crimson spots and a golden band through the center of each petal. 2 to 4 ft. high, blooming from July to October, Mammoth bulbs. Each, 25c; doz., \$2.75; 100, \$20.00.

Henryi (Yellow Speciosum). A beautiful Lily from China. Rich apricot-yellow, reddish brown spots. 5 ft. July and August. Each, 40c; doz., \$4.00.

Speciosum album. Large, fragrant, pure white. Each, 45c; doz., \$4.50; 100, \$35.00.

Speciosum magnificentum. Rich red, heavily spotted; much larger and richer colored than the other varieties. Mammoth bulbs. Each, 40c; doz., \$4.00; 100, \$30.00.



Lilium speciosum magnificentum



	Each	Doz.	100
Speciosum melpomene . White, shaded with rich blood-crimson; heavily spotted. Mammoth bulbs	\$0.40	\$4.00	\$30.00
Speciosum rubrum or roseum . White, shaded and spotted rosy crimson; fragrant. Mammoth bulbs40	4.00	30.00
Regale (Regal Lily). White, slightly suffused with pink, with a beautiful shade of canary-yellow at the center of the trumpet. Hardy60	5.00	40.00
Tigrinum splendens (Tiger Lily). Orange-salmon, spotted; the finest form20	2.50	18.00

Lily-of-the-Valley

(Convallaria)

Grey's Perfect Forcing Pips. The finest grade of pips that come to this country and especially selected for our large private trade, which demands only the best for forcing throughout the year. We carry these in cold storage and can furnish them at any time. Three to four weeks are usually allowed for forcing cold storage pips into flower. **Per case of 250, \$18.00.**

Regal
Lilies

GLADIOLUS

By F. F. Rockwell

We highly recommend this book to anyone interested in this popular flower.

\$1.25 per Copy

Gladiolus the Aristocrats of the Garden

For general garden decoration and for cut flowers the Gladiolus is deserving of special attention. Very effective for massing in large beds where a brilliant effect is desired. Of easiest culture, seldom disappointing and immune to insect pests. They thrive in well prepared, enriched loam, planted 3 inches deep and 6 inches apart. Frequent watering is very beneficial. We stock first size bulbs only. Six bulbs offered at the dozen rate.



	Doz.	100
Aida. Striking dark blue, small reddish throat blotches. Very early	\$0.80	\$6.00
Albatross. Very large pure white on tall spike of good standing	1.00	7.50
Ave Maria. Light blue with small purple blotches85	6.00
Bagdad. Very large, smoky old-rose, lighter throat80	6.00
Berty Snow. Large florets of beautiful clear lavender. Tall, straight spike and strong habit60	4.50
Betty Co-ed. Soft creamy pink. Several fan-sized florets open at a time	1.00	7.50
Betty Nuthall. Beautiful salmon-pink, with yellow throat markings70	5.00
Carmen Sylva. A pure white except for slight violet markings in throat. One of the best whites60	4.50
Charles Dickens. Rich purple-violet. Best of the color60	4.50
Commander Koehl. Dark scarlet without markings. Florets very large	1.00	7.50
Coryphee. Beautiful pink, similar to an Ophelia rose90	6.50
Crimson Glow. Deep crimson, lighter in throat. Exhibition variety55	4.00
Dr. F. E. Bennett. A very large, fiery red. Considered Diener's best red60	4.50

The World Renowned
PICARDY

GLADIOLUS—Continued

	Doz.	100
E. I. Farrington. A very beautiful rich self yellow. Many florets of fair size open at one time. One of the most popular yellows	\$.75	\$ 5.50
Giant Nymph. A giant in growth and flowers. Light rose-pink with creamy yellow throat60	4.50
Gloriana. A very fine large salmon, with yellow throat. No other markings...	.55	4.00
Golden Dream. Clear deep yellow; flowers recurved and distinct55	4.00
Kirchoff's Violet. Rarely beautiful dark blue flowers. Tall spike.....	.90	6.50
Maid of Orleans. A beautiful milky white, with light cream throat. Extra tall spike	1.35	10.00
Mammoth White. Immense white. Fine exhibition variety with very large florets90	6.50
Marmora. Lavender-gray color, with petunia colored blotch. A fine exhibition variety75	5.50
Mildred Louise. Strawberry pink, spectrum red penciling. Fine exhibition variety	1.75	12.00
Mother Machree. Beautiful combination of wine-tinted lavender, overlaid with salmon-pink	1.00	7.00
Minuet. New self colored lavender; rich, very large flower of heavy substance..	.75	5.50
Mrs. F. C. Hornberger. A fine white variety. Nicely ruffled, wide open blooms85	6.00
Mrs. F. C. Peters. Beautiful shade of rosy lilac, crimson blotched, bordered white on lower segment60	4.50
Mrs. P. W. Sisson. One of the best creamy, light pink varieties75	5.50
Mrs. Van Konynenburg. Aniline-blue of strong growth. A trifle darker than Heavenly Blue75	5.50
Orange Wonder. One of the best in the orange class. Vigorous grower75	5.50
Osalin. Beautiful coral-pink with soft orange markings in the throat65	4.75
Pearl of California. Flower is of the clearest softest La France pink, blending to a rosy white throat, with 8 to 12 open at a time	1.00	7.00
Picardy. One of the most outstanding varieties in existence. Soft shrimp pink, with flesh-pink lip. Blotch of light flesh pink shading to shrimp-pink at edges. Well placed on tall, strong spike70	5.00

	Doz.	100
Pelegrina. The newest and best of dark blues. Very tall grower	\$1.35	\$10.00
Primrose Princess. This is without doubt the best new yellow. Large, clear, light yellow. An exhibition novelty85	6.00
Salbach's Pink. Geranium pink with soft carmine tongue and throat markings.	.90	6.50
Scarlet Wonder. Rich, glowing scarlet-red, self color.....	.60	4.50
Sunnymede. Light orange with red blotch. Tall spike, with well placed blooms60	4.50
W. H. Phipps. Beautiful flesh-pink with about 22 blooms to a spike and nearly all opening at a time.....	.75	5.50

Primulinus Varieties

The following list of Primulinus we highly recommend. The colors are mostly yellows, oranges, pinks, etc., and they are specially desirable as cut flowers for vase work.

	Doz.	100
Affame. An outstanding red Primulinus variety. Enormous flowers on tall spike	\$0.60	\$ 4.50
Alice Tiplady. A soft burnt orange. The queen of the Primulinus type55	4.00
Apricot Glow. One of the finest of the Primis. Beautiful warm buff, edged soft apricot60	4.50
Golden Frills. Deep rich daffodil prim with strongly marked red blotches on lower petals.....	.60	4.50
Halloween. Tall growing, well placed spike, of orange bronze florets.....	1.35	10.00
Tiffany. Pure white, medium size florets on tall, straight spike.....	.75	5.50
Mixture. Containing a fine collection of popular named varieties50	3.50

Columbia Prize Mixture

Our choicest mixture, selected from the newer and better varieties, including only colors which harmonize well together.

Doz., 75c; 100 for \$5.50; 1000 for \$50.00.

Home Garden Mixture

A superior mixture including all colors and types.
Doz., 50c; 100 for \$3.00; 1000 for \$25.00.

Summer Flowering Bulbs—Continued

Acidanthera

Bicolor. A summer flowering bulb, having beautiful, creamy white fragrant flowers with a purple-maroon blotch at base of petals. Doz. \$1.75, 100 \$12.00.

Begonias

Splendid pot plants for the house or greenhouse, and especially valuable for bedding, flowering in the greatest profusion throughout the summer. For bedding they should be started in hotbed in March and April.

Single Tuberos Rooted

Separate Colors. Crimson, rose, orange, pink, white, yellow, salmon, scarlet. Each 25c, doz. \$2.75, 100 \$20.00.

Double Tuberos Rooted

Separate Colors. Crimson, orange, rose, pink, white, yellow, salmon, scarlet. Each 25c, doz. \$2.75, 100 \$20.00.

Cannas, Dormant Roots

Large-Flowering French Mixed. Finest varieties. Each 12c, doz. \$1.25.

Dahlias

Special Dahlia Catalog mailed on application.

Gloxinias, Large Flowered

Delivered January.

Magnificent for house or conservatory, producing in great profusion flowers of the richest and most beautiful colors. They succeed best in sandy loam and peat, and require a moist heat.

Separate Colors. Dark purple, white with scarlet border, scarlet, rose, white with purple border. Each 50c, doz. \$5.00.



Montbretias

Hyacinthus Candicans

A hardy summer-flowering Hyacinth with spikes of white bell-shaped flowers. Height 3 feet. Doz. \$1.10, 100 \$8.00.

Montbretias

One of the best and brightest summer-flowering bulbs, sure of becoming firm favorites wherever grown. Planted in clumps from April to June they produce numerous graceful spikes of brilliant star-shaped flowers. Hardy with protection.

Aurea. Pure orange-yellow. Doz. \$1.00, 100 \$7.00.

Hereward. Late, large flowering, yellow, shaded orange on the outside. Doz. \$1.00, 100 \$7.00.

His Majesty. A vigorous new seedling with handsome foliage. Outside bright red, inside scarlet with yellow center. Doz. \$2.00, 100 \$15.00.

James Coey. Vermilion-scarlet with clear luster, center yellow with crimson blotches. Doz. \$2.00, 100 \$15.00.

Lord Nelson. Deep orange-scarlet, externally crimson, eye yellow. Doz. \$1.25, 100 \$9.00.

Nimbus. Golden, edged with a crimson ring around the base. Doz. \$1.75, 100 \$12.00.

Rosea. Clear pale pink. Doz. \$1.00, 100 \$7.50.

Una. Inside of flowers apricot. Outside red with crimson blotch in center. Doz. \$2.00, 100 \$15.00.

Tuberose

Delivered March

Double Excelsior Pearl. Summer flowering bulbs, producing tall spikes of fragrant, double white flowers. Start in pots in rich loam and transplant into the garden. Doz. \$1.10, 100 \$8.50.

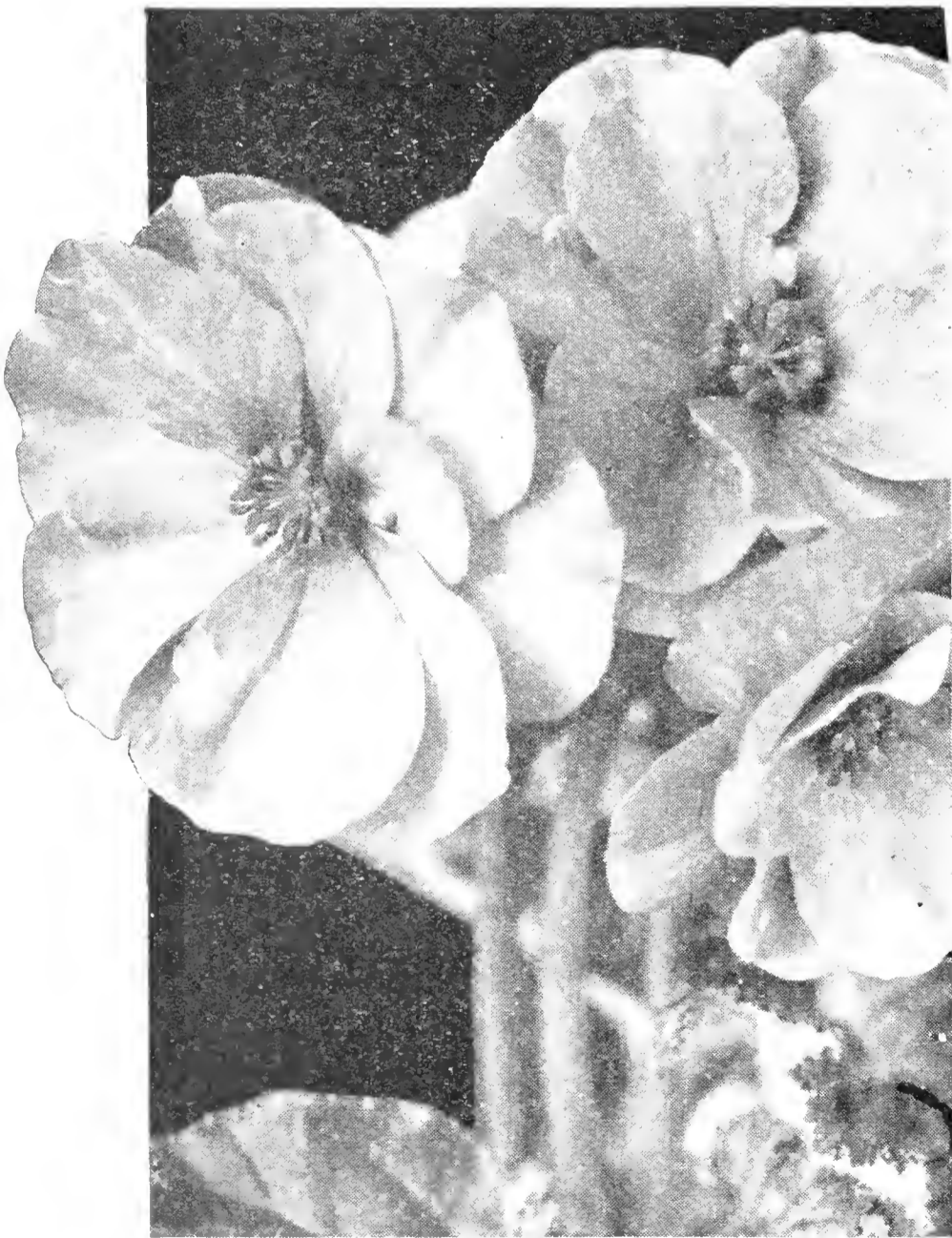

Single Tuberos Rooted Begonia

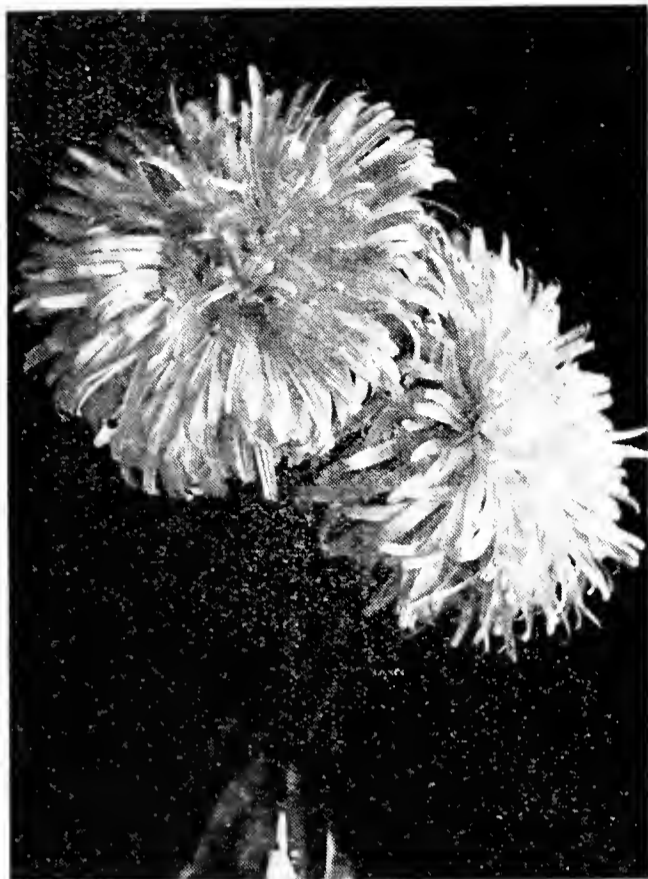

Asters

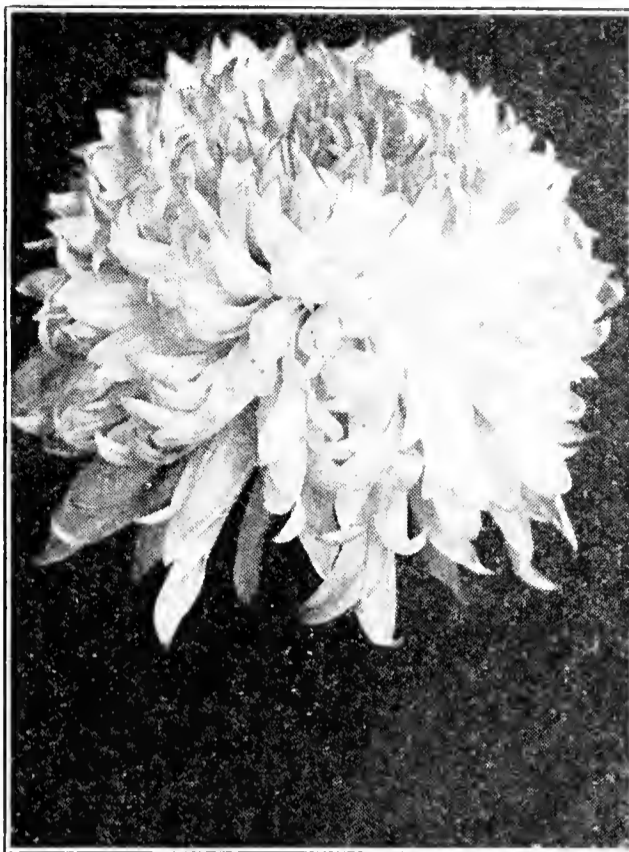

Chrysanthemums

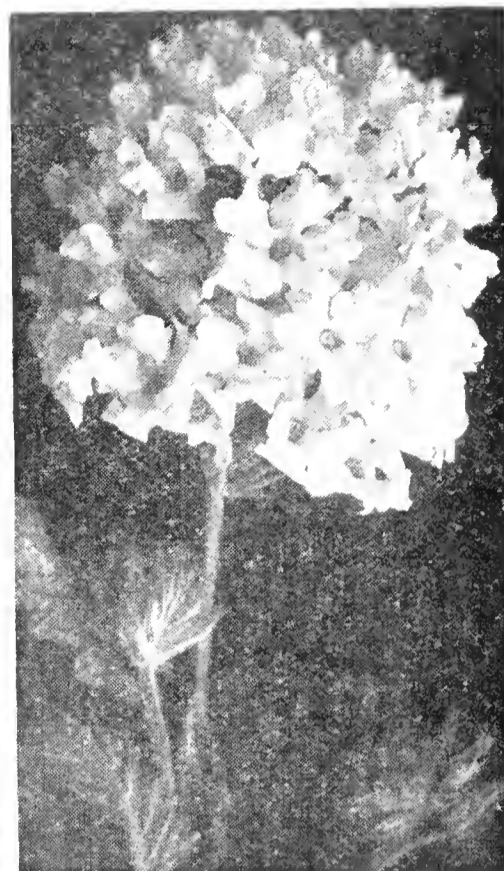

Verbena

Foliage and Flowering Plants For Summer Bedding

	Doz.	100
Abutilon	\$2.50	\$19.00
Alternanthera. Dwarf scarlet	1.25	8.50
Alternanthera. Dwarf yellow	1.25	8.50
Achyranthes. Bright crimson	1.50	10.00
Achyranthes. Green and white	1.50	10.00
Ageratum. Blue or white	1.75	12.50
Alyssum, Double White	1.25	8.50
Alyssum, Single White	1.00	7.50
Antirrhinum (Snapdragon). Assorted	1.75	12.50
Asters. Assorted colors. Double50	3.50
Asters. Double white50	3.50
Begonia. Tuberous-rooted mixed	4.00	30.00
Begonias. In variety	2.50	18.00
Caladium esculentum	3.00	23.00
Calendula, Orange King	1.50	10.00
Cannas, Dwarf Large-Flowering French	2.00	15.00
Cannas. In the following varieties: Ambassador, City of Portland, King Humbert, Yellow King Humbert, King Midas, Mrs. Alfred Conard, The President, Hungaria	2.25	17.00
Centaurea candidissima	1.50	10.00
Centaurea gymnocarpa	1.50	10.00
Chrysanthemums. Our collection of these beautiful fall blooming plants embraces the best of the old and newer introductions	2.50	
Cobaea scandens	2.25	17.00
Coleus. Fine varieties	1.25	8.50
Cosmos. Early flowering	1.00	7.50
Daisy, Double English. Assorted85	6.00

	Doz.	100
Daisy, Paris Golden. Single yellow	\$3.00	\$23.00
Daisy, Paris White. Single white	3.00	23.00
Feverfew, Double White	1.75	12.50
Feverfew, Golden Feather	1.25	8.50
Fuchsias. In variety	3.00	23.00
Geranium, Double Varieties	3.00	23.00
Geranium, Single Varieties	3.00	23.00
Geranium, Ivy-Leaved Sorts	3.00	23.00
Heliotrope, Giant Elsa	2.75	22.00
Heliotrope. Dark and light	2.25	17.00
Lantanas. In variety	2.00	15.00
Lobelia. Dark blue, for bedding	1.25	8.50
Marigold, Dwarf French	1.25	8.50
Mignonette, Large-Flowered	1.00	7.50
Nicotiana affinis. White, fragrant	1.25	8.50
Nicotiana sanderae. Carmine	1.25	8.50
Pansy. Special strain, extra choice70	5.00
Petunia, Double. Assorted colors	2.25	17.00
Petunia, Single. Assorted colors	1.25	8.50
Phlox drummondii. Assorted	1.25	8.50
Ricinus (Castor-Oil Bean)	1.75	12.50
Salpiglossis. Mixed colors	1.50	10.00
Salvia splendens. Best scarlet	1.75	12.50
Torenia fournieri. Blue	1.50	10.00
Verbena. Assorted colors	1.25	8.50
Verbena. Lemon-scented	3.00	23.00
Vinca alba and rosea (Flowering Vinca)	1.25	8.50
Vinca variegata (Periwinkle). Trailing	2.50	19.00
Wallflower, Mixed	1.75	12.50
Zinnia, Columbia Prize. Assorted	1.00	7.50

PALMS, FERNS AND GREENHOUSE PLANTS.
Quotations on application.

Many other varieties not mentioned in this list can be furnished at regular prices.

Select List of Hardy Perennial Plants

We can furnish a good selection of hardy plants, which may be expected to give successional bloom throughout the spring, summer and fall months, and, if the choice is left to us, will take special care to select such varieties as afford the most satisfactory results.

We also furnish estimates on the laying out, planting and improvement of private estates, and furnish experienced gardeners to carry out the work. We shall be pleased to correspond with those contemplating improvements or planting hardy stock of any sort.

PARCEL POST—Add six cents for one plant, two cents for each additional plant.

The price of all perennial plants on this and succeeding pages: 25c each, \$2.50 per doz., \$18.00 per 100, except as otherwise noted. Six perennials of one kind are entitled to the doz., and twenty-five of one kind to the hundred rate.

ACHILLEA (Milfoil or Yarrow).

ptarmica fl. pl. var., The Pearl. Double white flowers, most useful for cutting. June to October.

ACONITUM napellus (Monkshood). Dark blue flowers from July to September. 3 ft. Each 35c.

fischeri. A dwarf variety with pale blue flowers. September. 18 in. Each 35c.

Sparks' Variety. The darkest blue of all. Flowers in June.

AJUGA reptans (Bugle Plant). 6 in. Blue. Excellent for rock work, covering banks and shady places. May.

ALYSSUM saxatile compactum (Basket of Gold). 1 ft. A grand plant for the rockery or border. April to June.

ANCHUSA italica, Dropmore Variety. 3 to 4 ft. A lovely shade of gentian blue, and blooms the entire season.

myosotidiflora (Forget-Me-Not Flowered Anchusa). Grows 12 inches high and is covered during April and May with sprays of rich blue flowers.

ANEMONE, japonica alba, 2 to 3 ft. Flowers large, white. One of the best. September to November.

japonica, Queen Charlotte. 2 ft. Large, semi-double, silvery pink. September.

japonica, Whirlwind. 2 to 3 ft. Large, semi-double, pure white. September.

hupehensis. Pink. September and October. 2 ft.

pulsatilla. Lilac-blue flowers early in spring, prefers dry location in full sun. Fine rock plant.

September Charm. New. Rosy pink flowers. September 15th. Erect habit and free flowering.

ANTHEMIS tinctoria (Golden Marguerite). 2 to 3 ft. Lemon-yellow. June to October.

AQUILEGIA (Columbine).

alpina. Dwarf, short-spurred, blue flowers.

Long-Spurred Hybrids. 2 ft. These embrace all the colors of the long-spurred type. May to July.

chrysantha (Golden). 2 to 3 ft. Yellow long-spurred flowers. May to August.

caerulea (Rocky Mountain Blue Columbine). 2 ft. Long spurs, blue and white flowers. May to July.

Mrs. Scott Elliott Hybrids. Wonderful pastel colors with very long-spurred flowers.

ARABIS alpina (Rock Cress). 6 in. Early white spring-flowering plants. Fine for rock work and borders. April to June.

ARMERIA maritima (Sea Pink or Thrift). 1 ft. A fine plant for rockeries or edgings; flowers bright pink.

ARTEMISIA lactiflora (Wormwood). A tall growing plant of fine foliage and heads of small white flowers in August and September.

Silver King. White foliage. A fine filler for bouquets.

ASCLEPIAS tuberosa (Butterfly Weed). Very attractive native plants, flowering during July and August, and growing about 2½ ft. high. Umbels of bright orange-colored flowers.

ASTER (Michaelmas Daisies).

Blue Gem. Double, dark blue. 4 to 5 ft. September and October.

Climax. 5 ft. Light bluish lavender. August to October.

Peggy Ballard. 3 ft. Large pyramidal sprays of double rosy mauve flowers.

Queen Mary. Blue, tinted lavender flowers, 2½ inches across. 3½ ft.

St. Egwin. 2½ ft. Bright pink. September and October.

White Lady. Large white flowers.

Ypres. Rosy red. 2 to 3 ft.

ASTER (New Dwarf Varieties)

This collection will fill a long felt want in providing a race of dwarf, compact, free flowering plants blooming in September, at a season when there is a scarcity of low growing plants. Unsurpassed for borders and the Rock Garden.

Countess of Dudley. Clear pink with contrasting yellow eye. Bushy habit, free flowering and grows 9 inches high.

Lady Henry Maddocks. Pale pink. Flowers produced freely. Grows 12 inches high.

Marjorie. Compact habit, bearing large flowers of bright rose-pink.

Nancy. Bushy plants completely covered with pale flesh-pink flowers. Height 12 inches.

Ronald. Pleasing shade of bright lilac-pink following rose-pink buds. 12 inches high.

Victor. The most dwarf of all with clear lavender-blue flowers.

Any of the above \$0.35 each; \$3.50 per dozen.

AUBRIETIA (Rainbow Rock Cress). Dwarf, suitable for rockery. Sheets of various colored flowers in spring.

BAPTISIA australis (False Indigo). 2 ft. Long racemes of dark blue flowers. June to July.

BOLTONIA asteroides (False Chamomile). 5 to 6 ft. Fine late-flowering perennials. Aster-like white flowers. August and September.

latisquama. 4 ft. Flowers clear lavender; fine for cutting.

CAMPANULA carpatica (Harebell). 9 in. Erect blue flowers, useful for edgings. June to September.

carpatica alba. 9 in. Pure white.

medium (Canterbury Bells). 3 ft. Biennial. Flowers blue, white and rose. Separate colors. June and July.

medium calycanthema (Cup-and-Saucer). Biennial. Separate colors.

persicifolia (Bellflower). Peach-leaved. 2 ft. Blue. June to August.

persicifolia alba. 2 ft. White. June to August.

rotundifolia (Blue Bells). 1 ft. Blue. June to August.

CENTAUREA montana. 20 in. Large purple flowers. Fine for cutting. June.

CERASTIUM tomentosum (Snow-in-Summer). 5 to 6 in. Low growing plant. Silvery foliage, white flowers; fine for rockeries.

CHELONE lyonii (Turtlehead). 2 ft. Showy deep red flowers, bearing Snapdragon-like blooms and spikes. August to September.

Hardy Perennial Plants

CHEIRANTHUS, Alloni. (Siberian Wallflower.) Brilliant orange flowers in June. 12 inches.

CHRYSANTHEMUMS (Hardy Garden Varieties)

Coreanum (Korean Chrysanthemum). 2 to 3 ft. September and October. A superb garden plant, coming into bloom before the first frosts. Flowers are single, 2 to 3 inches across, white at first, acquiring a rose-pink tinge.

Barbara Cummings. Double yellow. Early.

Brown Bessie. Pompon. Reddish bronze.

Crimson Splendor. Rich crimson-maroon. Late Sept.

Daybreak. Large shell pink, single.

Glory of Seven Oaks. Large yellow. Early.

Granny Scovill. Large coral-bronze. Oct. 10.

Jean Treadway. Large pink. Early.

L'Argenteuillais. Deep chestnut. Early.

Model. Light yellow pompon.

Mrs. Nellie Kleris. Deep pink. Early.

Oconto. Japanese. White. Large. October 15.

October Girl. Pink.

Old Homestead. Pink. Large.

Ruth Hatton. Rosy pink.

Skibo. Golden yellow. Pompon. October 20.

Tennyson. Large chestnut brown.

Vivid. Rosy crimson. Early.

Burbank's Shasta Daisy. 1½ ft. Large snow-white flowers; blooms all summer.

NEW KOREAN CHRYSANTHEMUMS. A new distinct type of chrysanthemum that blooms earlier, adds new color and new hardiness. Can be used where winter killing has been a serious objection.

Apollo. Combination of bronze, red and gold.

Ceres. Combination of yellow and soft coppery bronze.

Clio. Dwarf habit, deep carmine rose.

Daphne. New shade of pink.

Diana. Rose pink and soft salmon.

Fortuna. Medium height, oxblood red.

Hestia. Semi-double rose pink.

Juno. Dwarf, single coppery red.

Mars. Deep amaranth red.

Niobe. Dwarf, white with yellow discs.

Nysa. Tall, clear rosy lilac.

Psyche. Medium height, shell pink.

Sappho. Dwarf, pure yellow.

Thalia. Medium height, bright orange.

Vesta. Deep golden orange.

35 cents each, \$3.50 per doz.

COREOPSIS. One of the best blooming all-summer plants we have.

lanceolata grandiflora. 2 ft. Large golden yellow.

DELPHINIUM (Larkspur).

belladonna. 3 ft. Sky blue.

bellamosum. 3 ft. Dark blue.

chinensis. 2 ft. Gentian blue. Blooms all summer.

chinensis album. 2 ft. Blooms all summer.

Choice Mixed English Hybrids.

DIANTHUS plumarius (Garden Pinks). A valuable and showy border plant; single and double. Very fragrant. May to August.

barbatus (Sweet William). 1 to 1½ ft. Mixed varieties. June and July.

deltoides (Malden Pink). A dwarf trailer with rosy pink flowers. June to August.

Rose de May. Dwarf single pink.

DICTAMNUS fraxinella (Gas Plant). 2½ ft. Rosy crimson, fragrant foliage. May to July. 50c each.

DIELYTRA, or DICENTRA. A hardy perennial with heart-shaped rose-colored flowers in drooping spikes.

Eximia. Handsome, reddish purple flowers and delicate foliage. Plant about one foot high. May to August.

Spectabilis (Bleeding Heart, or Seal Flower). An old-fashioned favorite; its long racemes of graceful heart-shaped pink flowers are always attractive. 50c each.

DIGITALIS (Foxglove). The flower heads are over 3 ft. long, crowded with big, bell-shaped blossoms. Colors range from white and shell-pink to deepest rose.

DORONICUM excelsum (Leopard's Bane). Large, bright yellow daisy-like flowers. Early.

ECHINOPS ritro (Globe Thistle). Showy thistle-like plants with metallic-blue globular flowers. 3 ft. July to Sept.

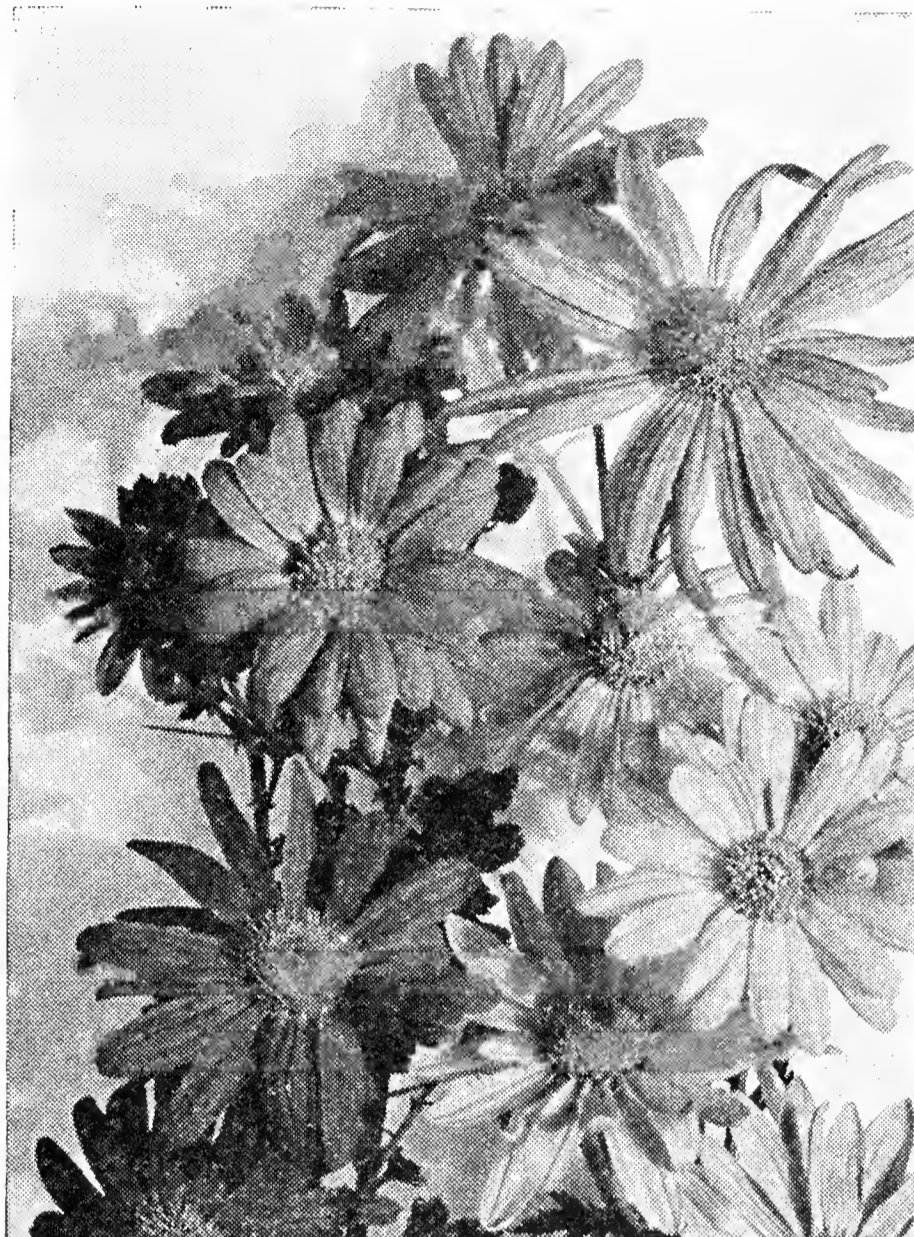

Korean Chrysanthemum

EUPATORIUM COELESTINUM (Hardy Ageratum). Light purple flowers similar to Ageratum. Flowers from Aug. to frost.

FUNKIA (Plantain Lily). A beautiful class of plants growing well in partial shade.

subcordata grandiflora (White Day Lily). 2 ft. A pure white trumpet-flowered and fragrant species. July to September.

undulata variegata. 1 ft. Beautiful variegated foliage, flowers lilac.

GAILLARDIA grandiflora (Blanket Flower). 2 ft. Large crimson and gold; good for cutting. June to November.

GEUM Mrs. Bradshaw (Avens). Double flowers of bright red. Blooms all summer.

GYPSOPHILA paniculata (Baby's Breath). 2 ft. An old-fashioned favorite; very useful, pure white flowers. June to August.

Bristol Fairy. Double. 50c each.

Repens. A creeping variety with tiny white flowers. A good rockery plant.

HELENIUM autumnale rubrum. 5 ft. Reddish brown, aster-shaped flowers; profuse bloomer. August to October.

autumnale superbum. 5 ft. Immense heads of golden yellow flowers. August to October.

Riverton Gem. Old gold suffused with terra cotta. August to October.

HELLEBORUS niger (Christmas Rose). Pot grown plants. \$1.00 each.

HELIOPSIS pitcheriana (Ox-Eye). 3 ft. Very desirable, blooming all through the summer. Deep orange-yellow.

Plants on this page 25c each, \$2.50 per doz., \$18.00 per 100, except as noted. Six plants of a variety will be furnished at the dozen rate; less than six at the single rate.

Hardy Perennial Plants

HEMEROCALLIS (Day Lily). Does well in partial shade and moist places.

flava. 3 ft. Golden yellow. May and June.

thunbergi. Very fragrant flowers; lemon-yellow, blooms in late spring.

HEUCHERA sanguinea. 1½ ft. Graceful spikes of delicate coral-red flowers. June and July.

HIBISCUS, Crimson Eye (Mallow). 4 ft. Large, pure white, with crimson spot in center. July and August.

moscheutos roseus. 4 ft. Pink. July and August.

moscheutos albus. 4 ft. White. July and August.

HOLLYHOCKS. Finest double variety. Separate colors or mixed.

Finest Single Varieties.

IBERIS sempervirens (Candytuft). 1 ft. Evergreen foliage; good for borders. May and June.

IRIS germanica (Garden Iris). They form a group unparalleled in beauty. Every shade of color may be found among them, and they will thrive in almost any soil or situation.

Alcazar. Tall deep purple.

Allure. Rose-pink.

Asia. Silver standards, purple falls.

Bruno. Bronze standards, purple falls.

Buto. Deep blue-purple.

Caprice. Chinese violet.

Coronation. Best yellow.

Cinnabar. Violet.

Duke of Bedford. Large deep purple.

Elizabeth Egelberg. Fine rose tone.

Euphony. Ruffled copper.

Freida Mohr. Pink bicolor.

Firefall. Bronze-red.

Gertrude. Dark blue.

Lent A. Williamson. Soft lavender-violet; falls royal purple.

Lord of June. Large lavender-blue.

Midgard. Yellow and pink blend.

Seminole. Violet-rose and crimson.

Wedgewood. Blue.

IRIS, Japanese (Iris Kaempferi).

35c each, \$3.50 per doz. Double, except where noted.

Blue Danube. Blue with pure white veins, yellow center.

Gold Bound. White; yellow markings.

Hercule. Clear lilac-blue.

Mahogany. Mahogany-red.

Oniga-Shima. Violet-purple, golden center.

Purple and Gold. Violet-purple.

Uchiu. Blue with golden center, and white.

LAVANDULA vera. True lavender. 2 ft. Fragrant bluish flowers; foliage gray, with fragrance of lavender.

LIATRIS pycnostachya (Blazing Star). 4 ft. Showy spikes of rosy purple flowers. July to September.

LILY-OF-THE-VALLEY. Strong clumps. 50c each, \$5.00 per doz.

LINUM perenne. 18 in. Light blue flowers, which are produced all summer.

LOBELIA cardinalis (Cardinal Flower). 3 ft. Cardinal-red. August to October.

LYCHNIS chalcedonica (London Pride). 3 ft. Brilliant heads of crimson flowers. June to September.

viscaria. 1½ ft. Single, scarlet flowers, brilliant. July and August.

LYTHRUM roseum superbum. 3 ft. Spikes of deep rose-colored flowers. September.

MONARDA didyma (Oswego Tea). 3 ft. Aromatic foliage and bright scarlet flowers. June to September.

MYOSOTIS palustris (Forget-Me-Not). 10 in. Flowers all summer. Fine blue.

NEPETA mussini. Dwarf, covered with light blue flowers. Fine for rock garden. May to September.

OENOTHERA (Evening Primrose).

youngi. 18 in. Bright yellow. June to September.

PAPAVER orientale (Oriental Poppy). 3 ft. Brilliant scarlet with black center; very showy. June.

Mrs. Perry. Salmon-rose.

nudicaule (Iceland Poppy).

PENTSTEMON barbatus torreyi (Beard Tongue). 4 ft. Bright scarlet flowers. July to September.

digitalis. 3 ft. Pure white. July and August.

PEONIES (Paeonia). One of the hardiest flowering plants and rivaled only by the Rose.

Alsace-Lorraine. White, much like the white Pond Lily. Late. \$1.25 each.

Couronne d'Or. Pure white globular flowers, with amber-yellow stamens. Late. \$1.00 each.

Dorchester. Large and compact. Pale hydrangea-pink. Fragrant; late. \$1.00 each.

Dorothy Allison. Bright, fresh pink; dwarf habit. Mid-season. Single. \$2.00 each.

Duchesse de Nemours. Medium sized, pure white bloom. Strong, free bloomer; fragrant; early. 75c each.

edulis superba. Rose-pink, very fragrant. Early. 75c each.

Eugenie Verdier. Flesh pink; extra fine variety, late. \$1.50 each.

Felix Crousse. Large, globular bloom. Brilliant red and a free bloomer. Fragrant; midseason. \$1.00 each.

Festiva Maxima. Very large; pure white center, petals tipped with bright crimson. Midseason. 75c each.

Georgiana Shaylor. Pale pink flecked with crimson; fine blooms late in the season. \$1.00 each.

Ginette. A flesh pink variety, very fragrant. Early. \$1.50 each.

James Kelway. A pure white variety, blooms early mid-season. \$1.50 each.



Mons. Jules Elle Peony

Plants on this page, 25c each, \$2.50 per doz., \$18.00 per 100, except as noted. Six plants of a variety will be furnished at the dozen rate; less than six at the single rate.

Hardy Perennial Plants

PEONIES—Continued.

- Lady Lillian Ogle.** Early single, pure white, fragrant. \$1.00 each.
Le Cygne. Pure milk white, incurved petals, midseason. \$2.00 each.
Madame de Verneville. Very large; pure white with center petals blush, tipped carmine. 75c each.
Monsieur Jules Elie. Large, compact. Pale lilac-rose with silvery reflex; fragrant, midseason. \$1.00 each.
Norfolk. Deep shell-pink with cup-shaped petals. Late. \$1.00 each.
Venus. Delicate shell-pink, compact bloom. \$1.50 each.
Walter Faxon. Large blooms; bright rose, deepening toward the center; fragrant; midseason. \$2.00 each.

PAEONIA officinalis, alba, rubra, rosea. \$1.00 each; \$10.00 per doz.

PEONIES, Mixed.

PHLOX paniculata (Hardy Perennial Phlox). A succession of flowers of greatest beauty, from early July until frost, in softest tones of pink and rose, salmon and white in great paniced blooms.

B. Comte. French purple. Medium.

Beacon. Bright red.

Betty Lou. Orange-scarlet.

Comus. New. Clear cherry-red, overspread bright scarlet.

E. I. Farrington. Soft salmon-pink. An improved Elizabeth Campbell.

Enchantress. Salmon-pink. Medium.

Europe. White; decided crimson eye. Tall.

Feuerbrand. Brilliant crimson-scarlet.

Jeanne d'Arc. Pure white; late. Medium.

Jules Sandeau. Large salmon-pink.

La Vague. Mauve with carmine eye.

Leo Schlageter. New. Its brilliant scarlet blooms seem to glow with fire. Has a decided orange cast. Splendid habit. The best red Phlox in existence today.

Miss Lingard. White with pale pink center. Early.

Mrs. Jenkins. Beautiful clear white. Medium.

Mrs. Milly van Hoboken. New. Large soft pink.

Painted Lady. Silver-pink with red eye.

Pantheon. Brilliant rose, very effective. Tall.

Rheinlander. Beautiful salmon-pink. Medium.

R. P. Struthers. Bright pinkish-salmon. Crimson eye.

Special French. Beautiful clear pink. Tall.

Thor. Deep salmon-pink. Tall.

PHLOX divaricata. 1 ft. Dwarf. Pale blue. Native variety. May and June.

subulata (Moss Pink). 4 to 6 in. Pink. April and May.

subulata alba. 4 to 6 in. White.

PHYSOSTEGIA virginica (False-dragonhead). One of the most attractive mid-summer plants, covered with clear pink, heath-like flowers. July and Aug.

Vivid. New dwarf variety with deep pink flowers.

PLATYCODON grandiflorum (Japanese Balloon Flower). 2½ ft. Large blue, Campanula-like flowers. July to Oct.

grandiflorum album. 2½ ft. White.

PLUMBAGO LARPENTAE (Leadwort). Dwarf and spreading. Covered with deep blue flowers during late summer.

PRIMULA (English Primrose). Bright canary-yellow. April and May.

denticulata. Neat, hardy species from Himalaya. Flowers early. Pale violet. 9-12 inches tall.

PYRETHRUM roseum (Persian Daisy). 2 ft. One of the showiest flowers; of great value for cutting. June to July. Single. Mixed.

uliginosum (Giant Daisy). 4 ft. Large white. Aug. and Sept.

RUDBECKIA purpurea. 3 ft. Large, reddish purple, with dark, cone-shaped center of brown. July to Oct.

SAPONARIA Ocymoides (Soap Wort). Attractive bright rose flowers, May to August. 8 in. A fine rock plant.

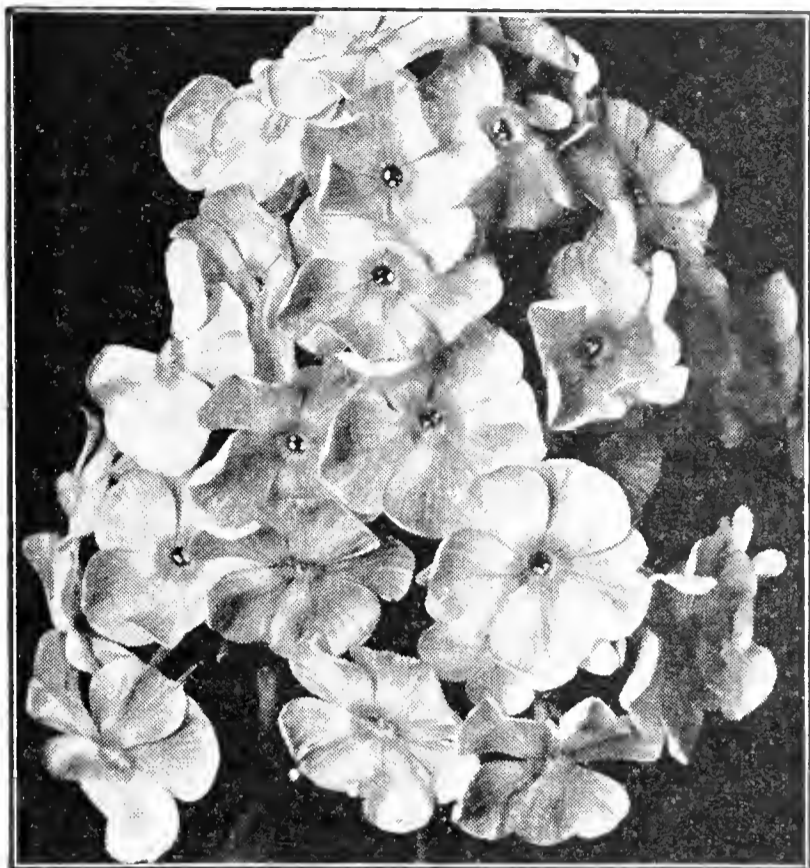

Phlox, Beacon

SCABIOSA caucasica (Blue Bonnet). A soft and charming shade of lavender. June to September.

SEDUM acre (Golden-moss). 4 in. Bright yellow, with green foliage. May to July.

album. 4 in. Green foliage, white flowers. July and Aug.

sexangulare. Dark green foliage. Yellow flower. 6 in.

sieboldii. Showy pink flowers. September to October. 8 in.

spectabile (Showy Stonecrop). 18 in. An erect growing plant with broad green foliage and large heads of handsome rose-colored flowers.

spectabile, Brilliant. 1 ft. Sept. and Oct. A more richly colored form of *S. spectabile*, being a bright amaranth-red.

SPIRAEA filipendula fl. pl. 2 ft. Double white. June and July.

STATICE latifolia (Sea Lavender). 1½ ft. Violet-blue. July to Sept.

STOKESIA cyanea (Cornflower Aster). 2 ft. Lavender-blue. A native plant; fine for cutting. July to Oct.

alba.

THYMUS lanuginosus (Woolly Thyme).

serpyllum (Creeping Thyme).

serpyllum album (White Mt. Thyme).

serpyllum coccineum.

Plants are covered with crimson flowers.

TRITOMA uvaria grandiflora (Flameflower). 4 ft. Orange-scarlet. Aug. to Nov.

TROLLIUS europaeus (Globeflower). 1½ ft. Bright yellow. June to Sept. 35c.

iedebouri. Rich orange. 35c.

VERONICA (Speedwell).

incana. Silvery foliage, blue flowers. July and August. 1 ft.

longifolia subsessilis. One of the handsomest blue flowering plants. 2 ft. July to Sept.

VINCA minor (Myrtle). Creeping evergreen; good for covering ground in shady places. Bright blue flowers. April to July. \$15.00 per 100.

VIOLA, Jersey Gem. Rich violet color, fragrant; fine for borders or rockeries.

Plants on this page 25c each, \$2.50 per doz., \$18.00 per 100, except as noted. Six plants of a variety will be furnished at the dozen rate; less than six at the single rate.

Hybrid Tea (Everblooming) Roses

Two-year dormant plants, 75c each; \$7.50 per doz.; \$50.00 per 100.
Pot-Grown plants, ready about May 15th. 85c each; \$9.00 per doz.

Ami Quinard. Extremely dark, velvety crimson-maroon, a vigorous grower.
Autumn. Gorgeous flowers of russet-brown, bronzy-red and rich yellow. Free bloomer.
Betty Uprichard. Semi-double, salmon-pink flowers stained with copper, pink on the outside.
Caledonia. The most desirable white. Long lasting.
Chas. P. Kilham. Scarlet-orange buds opening to brilliant orange-pink, shading to yellow.
Columbia. Extra large, glistening rose-pink, long stems.
Dame Edith Helen. Enormous, very double, pure pink blooms, continually produced.
Edith Nellie Perkins. Buds of rich orange, salmon-pink on interior, turning to golden shaded blooms.
E. G. Hill. Dazzling scarlet shading to deeper red.
Etoile De France. Deep crimson with cerise-red center.
Etoile de Hollande. The world's leading red rose with brilliant blooms of magnificent size.
General MacArthur. Very fragrant, bright scarlet-crimson.
Gruss an Teplitz. Profuse, fragrant blooms of dark velvety scarlet.
Jonkheer J. L. Mock. Outside of petals carmine, inside flesh pink.
Joanna Hill. Light yellow, with bronze shadings in center.
Kaiserine Augusta Victoria. Cream shaded lemon.
Killarney Pink. Flesh, shaded white, suffused pale pink.
Lady Forteviot. Delightfully sweet-scented rose, saffron-yellow, flushed with carmine and orange.

Los Angeles. Of flame pink, toned coral and gold.
McGredy's Scarlet. A beautiful formed, double, high-centered variety of brilliant red, borne on long stems.
Mev. G. A. Van Rossem. Buds yellow, veins orange-brown, full, double, fragrant flowers open lighter.
Miss Rowena Thom. Very large, brilliant rose-pink.
Mme. Caroline Testout. Beautiful silvery-rose.
Mme. Edouard Herriot. Coral or brick-red.
Mrs. Aaron Ward. Color Indian yellow, shading to lemon.
Mrs. Chas. Bell. Shell pink.
Mrs. E. P. Thom. One of the best yellows.
Mrs. Henry Bowles. A splendid, large, fragrant flower. Pink with salmon shadings.
Mrs. Pierre Du Pont. Reddish gold buds turn to lasting and fragrant blooms of deep golden-yellow.
Mme. Butterfly. Similar to Ophelia but larger flower.
Ophelia. Salmon-flesh, shading to rose.
Olympiad. Reddish pink flowers with orange undertone.
Padre. Coppery scarlet flushed with yellow.
President Herbert Hoover. An outstanding novelty of maroon, orange and gold; a perfect rose for the home garden.
Radiance. Soft carmine-pink. Double; sweet-scented.
Red Radiance. A crimson sport of Radiance.
Souvenir de Claudius Pernet. The best and one of the few really yellow, with a pointed bud and glossy foliage.
Talisman. Most vividly colored rose, apricot shading to yellow at base, strong grower, free bloomer.
White Killarney. A pure white rose.

New Patented Roses

Pot-grown plants only. Ready for delivery about May 15th.

Alezane. Plant patent No. 116. Large reddish brown buds, opening to sorrel with golden-yellow center, unfurling to rich apricot. \$1.50 each.
Better Times. Plant patent No. 23. The brilliant cerise flowers are large, double and delicately fragrant. Being produced on long strong stems, they are excellent for cutting; a very free bloomer. \$1.50 each.
Carrie Jacob Bond. Plant Patent No. 158. Double blooms of ideal form carried singly on long, upright stems. A rich deep rose color, enhanced by a luminous coral sheen. \$1.00 each.
Countess Vandal. Plant patent No. 88. A lovely coppery pink and gold, extra long pointed buds. \$1.00 each.

Climbing Roses

Two-year dormant plants, 50c each, \$5.00 per doz., except where noted.

American Pillar. Chaste pink, white center; single.
Blaze (U. S. Plant Patent No. 10). Everblooming Paul's Scarlet Climber. A vigorous climber producing flowers of the blazing color of Paul's Scarlet and the everblooming habit of Gruss an Teplitz. \$1.25 each.
Climbing American Beauty. Rose-pink; fragrant.
Crimson Rambler. Large clusters of crimson flowers.
Dr. W. Van Fleet. Flesh pink. Double and fragrant.
Dorothy Perkins. Soft shell-pink.
Doubloons (Plant Patent No. 152). A vigorous climber with heavy wood and handsome glossy foliage. Buds ovoid, deep saffron yellow, flowers large, double, cupped; rich gold, fragrant. Gives two liberal crops six weeks apart if the first spring blooms have not been cut. \$1.50 each.
Emily Gray. Long tapering, golden yellow buds. \$1.00 each.
Excelsa. Intense crimson maroon. Healthy foliage; fine.
Golden Climber (Mrs. Arthur Curtis James). Plant patent No. 28. A full semi-double yellow rose averaging four to five inches in diameter. Blooms of hybrid tea type, on stems often eighteen inches or longer. \$1.50 each.
Jacotte. Flower large, semi-double, coppery yellow, tinted coppery red.
Mary Wallace. Semi-double, rose-pink, with salmon base.
Max Graf. Trailing Hybrid Rugosa Rose. Valuable as a ground cover. Foliage of the Rugosa type. Flowers single and bright pink, 60c each, \$6.00 per doz.
Paul's Scarlet Climber. Vivid scarlet, semi-double flowers of medium size, produced in large clusters.
Silver Moon. Silvery white. Foliage is mildew proof.
The New Dawn. The everblooming Dr. W. Van Fleet. \$1.50.
White Dorothy Perkins.

Gloaming. Plant Patent No. 137. The color is a soft satiny pink heavily laden with salmon and amber. Delightfully fragrant. \$1.50 each.

Mary Hart. H. T. Plant Patent No. 8. A striking red sport of Talisman. The bud is maroon-red, opening to deep velvety blood-red with an overflow of amber. \$1 each.
Texas Centennial (Dixie Rose Co., 1935). Patent applied for. A sport of President Hoover having the same wonderful plant qualities. The color is blood red toning to cerise-red in the center. Very unusual. \$1.00 each.

Hybrid Perpetual Roses

Two-year dormant plants, 60c each; \$6.00 per doz.

Frau Karl Druschki. Pure white; large and free flowering.
General Jacqueminot. Brilliant crimson; fragrant.
George Arends. The pink Druschki. Soft pink.
J. B. Clark. Red.
Magna Charta. A bright, clear pink.
Mrs. John Laing. A constant blooming rose. Shell-pink.
Paul Neyron. A deep rose color; large.
Prince Camille de Rohan. Deep maroon-red.
Ulrich Brunner. Bright cherry-red; fragrant.

Baby Rambler Roses

Two-year dormant plants, 60c each; \$6.50 per doz.; \$50.00 per 100.

Elsie Poulsen. Pink flowers in clusters on long stems.
Gloria Mundi. Very double flowers of rich orange-scarlet.
Triomphe Orleanais. A very fine crimson.

Miscellaneous Hardy Roses

Rosa rugosa rubra. Red. 60c each, \$6.00 per doz.
Rosa rugosa alba. White. 75c each, \$7.50 per doz.
F. J. Grootendorst. A strong, shrubby grower. The flowers are produced in large clusters like the Crimson Baby Rambler. 2-year plants, 60c each, \$6.00 per doz.
Rosa Hugonis (Golden Rose of China). Early. 60c each.
Rosa Wichuriana (Memorial Rose). Single, white. 50c each.

Tri-O-Gen Rose Garden Spray

Combined spray treatment, fungicide, insecticide, and plant stimulant. Combined as a Kit. Harmless to foliage or blooms. Small Kit \$1.50; Medium Kit, \$4.00; Large Kit, (makes 32 gallons), \$6.00.

Deciduous Shrubs

Ornamental shrubs occupy an important place in the home garden. They present a variety of color, season of bloom and type of growth, as well as producing brilliant colored foliage in the fall and bright colored berries in the winter.

ALMOND (*Amygdalus*). Produces double, rose colored flowers in great profusion in early spring. 2 to 3 ft. 60c each; 3 to 4 ft. 75c each.

ALTHEA (*Hibiscus syriacus*). **Rose-of-Sharon**. Tall growing, late flowering shrubs of unusual beauty. Pink, purple, red and white. Bush form. 2 to 3 ft., 40c each; 3 to 4 ft. 50c each; tree form, 75c each.

ARALIA (*Acanthopanax pentaphylla*). A graceful shrub with spiny branches and bright green foliage. 2 to 3 ft., 35c each; 3 to 4 ft., 40c each.

AZALEA arborescens (Sweet Azalea). Fragrant white flowers in June. 1 to 1½ ft., \$2.25; 1½ to 2 ft., \$3.00 each.

kaempferi (Torch Azalea). Orange-red. 15 to 18 in., \$2.00 each; 18 to 24 in., \$2.50 each; 2 to 2½ ft., \$3.25.

calendulacea (Flame Azalea). Flame-red flowers late in May. 1 to 1½ ft., \$1.50 each; 1½ to 2 ft., \$2.00 each.

mollis (Chinese Azalea). Mixed colors. 12 to 15 in., \$1.75 each; 18 to 24 in., \$2.75 each.

nudiflora (Pinxterflower). Deep pink to reddish purple. 1 to 1½ ft., \$1.75 each; 1½ to 2 ft., \$2.25 each.

poukhanensis (Korean Azalea). Low growing; pale lilac purple. 15 to 18 in., \$2.00 each; 1½ to 2 ft., \$2.75 each;

viscosa (Swamp Azalea) Fragrant white flowers in July; prefers damp soil. 2 to 2½ ft., \$2.00 each.

BARBERRY, Japanese. See Hedge Plants, page 80.

Redleaf Japanese (*Berberis thunbergii atropurpurea*). 15 to 18 in., 40c each.

BERBERIS THUNBERGII PLURIFLORA ERECTA.

(U. S. Plant Patent No. 110). (True Hedge Column-berry). This new barberry is pyramidal in habit, with foliage of a dense deep shade of green. It is easily trained into perfect spires and pyramids and makes a beautiful hedge, requiring very little trimming. 12 to 15 in., 35c each, \$3.50 per doz; \$21.00 per 100. 15 to 18 in., 45c each, \$4.50 per doz; \$27.00 per 100; 18 to 24 inch, 60c each, \$6.00 per doz.; \$36.00 per 100; 2 to 2½ ft., 75c each, \$7.50 per doz.; \$50.00 per 100.

BUDDLEIA, Ile de France. Splendid new form of the useful Summer Lilac or Buddleia. Its long heavy sprays are densely covered with small violet purple flowers, each illuminated by a brilliant golden eye. 50c each.

CORALBERRY (*Symphoricarpos vulgaris*). Clusters of coral-red berries last throughout the winter. 2 to 3 ft., 35c each; 3 to 4 ft., 50c each.

COTONEASTER divaricata (Spreading Cotoneaster). A spreading variety with arching branches. Pink flowers are produced in June and bright red fruit in September. 18 to 24 in., 75c; \$7.50 per doz.

horizontalis (Rock Cotoneaster). A low shrub with horizontal branches and small glossy green leaves. The flowers are pinkish white and the fruit is bright red. A desirable variety for planting in the rock garden. 5 in. pots, 6 to 9 in., 60c each; 6 in. pots, 15 to 18 in., \$1.00 each.

DAPHNE mezereum (February Daphne). A small hardy shrub blooming long before the leaves appear. The stems are closely set with deep red, fragrant flowers. 15-18 in., 75c; 18-24 in., \$1.00; 2-2½ ft., \$1.25.

DEUTZIA gracilis. Dwarf; white flowers cover the entire plant in May. 1 to 1½ ft. 40c each.

lemoinei. Medium growth. White flowers on erect stems in June. 2 to 2½ ft., 40c each.

Pride of Rochester. Tall; double white flower tinged with pink; in late June. 2 to 3 ft., 40c each; 3 to 4 ft., 50c each.

DOGWOOD (*Cornus*). Strong growing shrubs, attractive for their bloom, berries, leaf coloring and colored bark.

Cornus alba. Flowers white, fruit blue, branches red. 3 to 4 ft., 50c each; 4 to 5 ft., 60c each.

Cornus elegantissima. Green foliage, edged with white; branches red. 3 to 4 ft., 75c each.

Cornus stolonifera flaviramea. Flowers white, branches yellow. 3 to 4 ft., 50c each.

EUONYMUS alatus (Winged Burningbush). A handsome shrub of medium growth. Peculiar winged branches; foliage light green changing to bright crimson in autumn. 2 to 3 ft., 50c each; 3 to 4 ft., 75c each; 4 to 5 ft., \$1.00 each.

a. compacta (Dwarf Winged Euonymus). A choice dwarf, compact shrub which is unquestionably one of the best deciduous shrubs for growing in the shade. For a low, wide hedge this variety has no equal. 12 to 18 in., 40c each; \$4.25 per doz.; \$30.00 per 100. 18 to 24 in., 50c each; \$5.50 per doz.; \$42.00 per 100.

FORSYTHIA (Golden Bell). First of the spring flowering shrubs. Rich green foliage; tall and graceful in habit. **fortunei**. Upright growth. 3 to 4 ft., 40c each; 4 to 5 ft., 50c each.

intermedia. Medium growth. 2 to 3 ft., 40c each; 3 to 4 ft., 50c each.

suspensa. Weeping in habit. 2 to 3 ft., 35c each; 3 to 4 ft., 50c each.

FRINGE TREE (*Chionanthus virginica*). A large growing shrub with heavy foliage and lacy white flowers. 2 to 3 ft., \$1.00 each; 3 to 4 ft., \$1.50 each.

HONEYSUCKLE (*Lonicera*). Tall, bushy, hardy shrubs.

Morrow Honeysuckle (*L. morrowi*). Medium height, drooping branches, white flowers, red fruit. 2 to 3 ft., 40c each; 3 to 4 ft., 50c each.

Tatarian Honeysuckle (*L. tatarica*). Tall, pink flowers, crimson fruit. 2 to 3 ft., 40c each; 3 to 4 ft., 50c each.

White Tatarian Honeysuckle (*L. tatarica alba*). Tall, white flowers, crimson fruit. 3 to 4 ft., 50c each.

HYDRANGEA arborescens grandiflora (Hills of Snow). Large clusters of white flowers in midsummer. 18 to 24 in., 35c each; 2 to 3 ft., 45c each.

paniculata grandiflora. The old-fashioned, common variety with large heads of white flowers in late summer which turn a bright pink in fall. 2 to 3 ft., 50c each; 3 to 4 ft., 75c each.

Standard or Tree Hydrangea. 4 to 5 ft., \$1.00 each.

JETBEAD (*Rhodotypos kerrioides*). Medium height; single, white flowers followed by shiny, black fruit which last throughout the winter. 2 to 3 ft., 50c each; 3 to 4 ft., 60c each.

KOLKWITZIA amabilis (Beautybush). A free growing shrub with tubular pink flowers produced abundantly in rounded clusters the whole length of the branches. 2 to 3 ft., 60c each; 3 to 4 ft., 75c each.

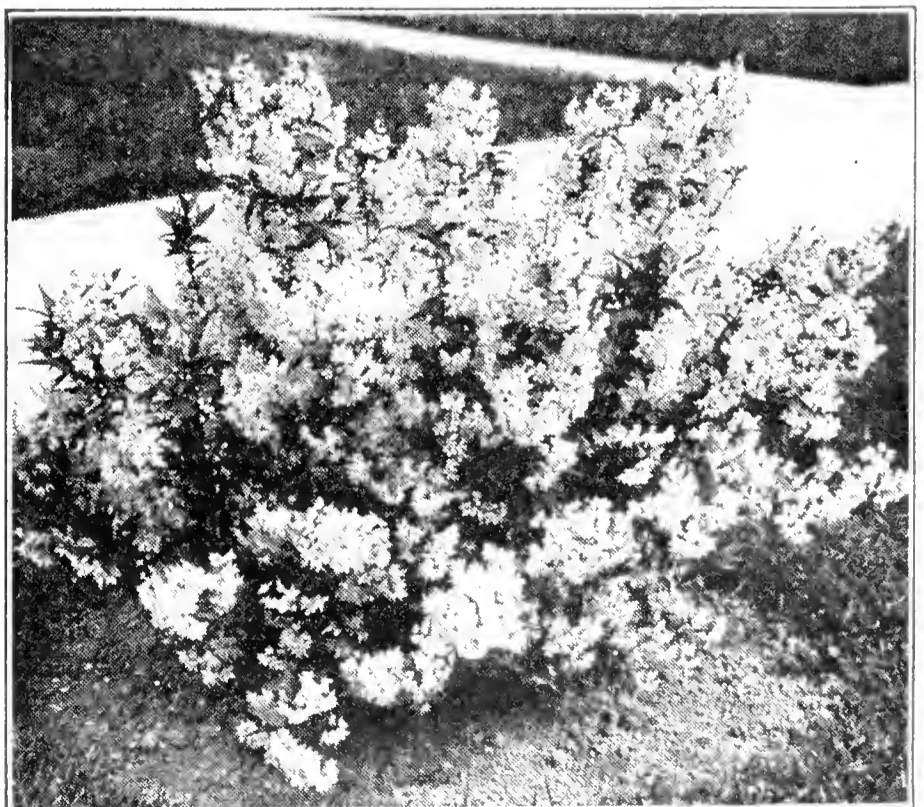

Deutzia gracilis

Deciduous Shrubs—Continued

LILAC (Syringa). Old-fashioned favorites familiar to all.
Common Purple. 2 to 3 ft., 40c each; 3 to 4 ft., 60c each.
Common White. 1½ to 2 ft., 40c each; 2 to 3 ft., 60c each; 3 to 4 ft., 75c each.

Persian Lilac. Very fragrant, pale purple flowers in loose panicles. 2 to 3 ft., 50c each.

Villosa Lilac. Heavy bright green foliage, flowers rosy white and fragrant; late blooming. 3 to 4 ft., 50c each; 4 to 5 ft., 75c each.

HYBRID LILACS. Unlike the old varieties, this type bloom when very young and their double and single blooms are produced in a wide range of color. The varieties listed are priced as follows: 1½ to 2 ft., 45c each; 2 to 3 ft., 60c each; 3 to 4 ft., 75c each; 4 to 5 ft., \$1.25 each.

Single Varieties:

Amelia Dupret. Pale lilac.

Chas. X. Reddish purple.

Congo. Dark crimson.

Marie Legraye. White.

Rubra de Marly. Purple.

Souv. de Ludwig Spaeth. Red.

Double Varieties:

Alphonse Lavallee. Light blue.

Belle de Nancy. Satin pink.

Doyonne Keteleer. Light pink.

Marlyensis Pallida. Reddish purple.

Mme. Lemoine. White.

Ville de Troyes. Dark purple.

PEPPERBUSH (Clethra alnifolia). Medium growth, white fragrant flowers in midsummer. 18 to 24 in., 50c each.

PRIVET (Ligustrum). Hedge varieties, see page 80.

Regel Privet (L. regelianum). Low-spreading shrub of graceful habit. A fine border shrub. 1½ to 2 ft., 40c each, \$4.00 per doz.

JAPANESE QUINCE (Cydonia japonica). Dark green, glossy foliage; scarlet flowers in May. 1½ to 2 ft., 40c each, 2 to 3 ft., 50c each.

FLOWERING RASPBERRY (Rubus odoratus).

A shade-growing plant of medium height; flowers rosy purple. 50c each.

SIBERIAN PEA-TREE (Caragana arborescens).

A hardy, tall growing shrub with dark green wood, light green foliage and small, pea-shaped flowers in June. 2 to 3 ft., 50c each; 3 to 4 ft., 60c each.

SMOKE BUSH (Rhus cotinus). Much admired for its clusters of purplish, misty flowers in June. 2 to 3 ft., 75c each; 3 to 4 ft., \$1.00 each.

SPIREA (Spiraea). An interesting family of flowering shrubs, covering a wide season of bloom. Very hardy.

Anthony Waterer. Dwarf; rose-pink blooms in July and Aug. 1½ to 2 ft., 35c each.

bumalda. A light pink variety of the above. 18 to 24 in., 40c each.

froebeli. A stronger grower than Anthony Waterer; rose-pink blooms in July and Aug. 1½ to 2 ft., 35c each; 2 to 3 ft., 45c each.

prunifolia. The true Bridalwreath. Tiny white flowers in great masses along the stems are produced late in May. 2 to 3 ft., 45c each; 3 to 4 ft., 55c each.

thunbergi. Medium growth; small white flowers in early May; graceful habit. 2 to 3 ft., 45c each.

trichocarpa (Korean Spirea). A newer variety much like *S. vanhouttei*, but blooming about two weeks later. 2 to 3 ft., 40c each; 3 to 4 ft., 50c each.

Vanhouttei. The finest of all Spireas. Graceful arching branches are completely covered with white flowers in June. 2 to 3 ft., 35c each; 3 to 4 ft., 50c each; 4 to 5 ft., 75c each.

STEPHANANDRA flexuosa. Spreading and drooping in habit; foliage finely cut and lacy; flowers white. 2 to 3 ft., 50c each.

SNOWBERRY (Symphoricarpos racemosus). A bushy shrub with slender branches which droop gracefully; white waxy berries cover the plant in fall. 2 to 3 ft., 35c each; 3 to 4 ft., 50c each.

SYRINGA.

Common Syringa (Philadelphus coronarius). Tall, pure white, fragrant flowers in June. 3 to 4 ft., 40c each; 4 to 5 ft., 50c each.

Golden Syringa (Philadelphus coronarius aurea). A dwarf variety with bright yellow foliage. 1 to 1½ ft., 50c each; 1½ to 2 ft., 60c each.

Large-Flowered Syringa (Philadelphus grandiflorus). A vigorous growing variety; white flowers. 3 to 4 ft., 40c each; 4 to 5 ft., 50c each.

Virginal. Very large semi-double, white flowers, blooming throughout the summer. 2 to 3 ft., 50c each; 3 to 4 ft., 60c each.

VIBURNUM.

Dwarf Viburnum (V. opulus nana). a dense, compact, dwarf plant useful for very low borders. 8 to 10 in., 30c each; 10 to 12 in., 40c each.

European High Bush Cranberry (V. opulus). A tall growing shrub producing large clusters of scarlet fruit late in the summer. 2 to 3 ft., 45c each; 3 to 4 ft., 50c each.

Common Snowball (V. opulus sterile). An old favorite. 1½ to 2 ft., 50c each; 2 to 3 ft., 60c each.

Japan Snowball (V. plicatum). A compact grower with heavy foliage. Round white flowers in May. 2 to 3 ft., 75c each.

Single Japan Snowball (V. tomentosum). 1½ to 2 ft., 50c each. 2 to 3 ft., 60c each.

May-flowering Viburnum (V. carlesii). Compact and bushy in growth; fragrant, pink flowers in May. A choice variety. 18 to 24 in., 75c each; 2 to 2½ ft., \$1.00 each; 2½ to 3 ft., \$1.25 each; 3 to 4 ft., \$1.50 each.

WEIGELA. These valuable shrubs produce trumpet-shaped flowers in great profusion during May and June.

candida. White. 2 to 3 ft., 60c each.

Eva Rathke. Dark reddish green foliage; dark red blossoms throughout summer. 2 to 3 ft., 50c each.

rosea. A tall growing variety, producing pink flowers in June. 2 to 3 ft., 50c each; 3 to 4 ft., 75c each.

Variegated. A dwarfish type with white margined leaves; flowers white. 1½ to 2 ft., 50c each; 2 to 3 ft., 75c each.

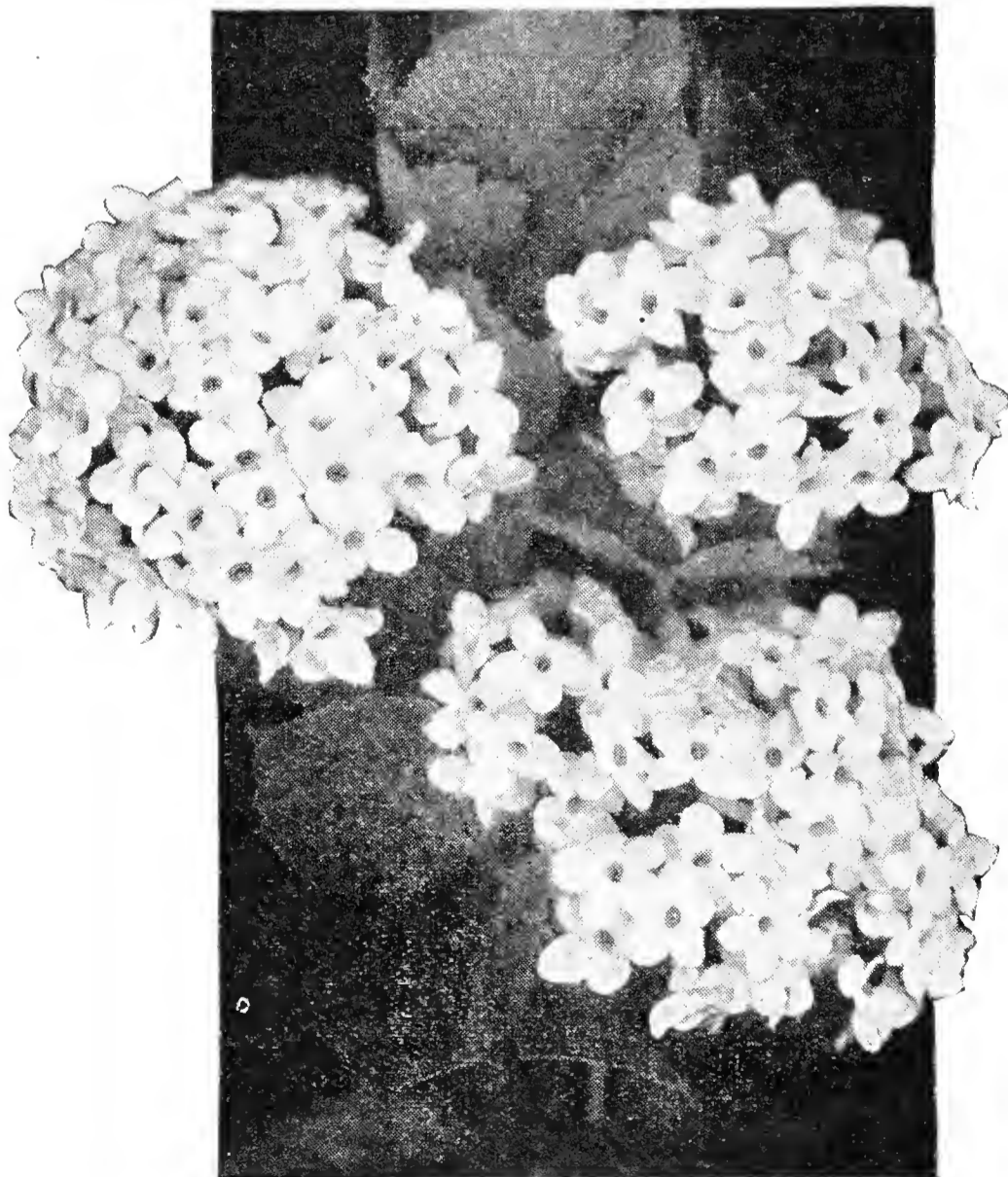

Viburnum Carlesii

Deciduous Trees

Ash - Fraxinus

American White (*F. americana*). A large, broad-headed tree suitable for lawn or street planting. 10 to 12 ft., \$2.00 each.

Beech - Fagus

European Beech (*F. sylvatica*). Light green foliage; compact in habit. 2 to 3 ft., \$1.50 each; 3 to 4 ft., \$2.50 each; 4 to 5 ft., \$3.50 each.

Purple Beech (*F. sylvatica purpurea*). Rich purplish foliage. A desirable lawn tree. 1½ to 2 ft., \$2.50 each; 2 to 3 ft., \$3.50 each; 3 to 4 ft., \$6.00 each.

Birch - Betula

European White Birch (*B. alba*). 6 to 8 ft., \$1.50 each.

Cutleaved Weeping Birch (*B. alba laciniata*). 5 to 6 ft., \$2.00 each; 6 to 8 ft., \$2.50 each; 8 to 10 ft., \$3.00 each.

Canoe Birch (*B. papyrifera*). 6 to 8 ft., \$1.75 each.

Catalpa

Umbrella Catalpa (*C. bungei*). Dense, globe-shaped heads on slender stems. 1 yr. heads, \$2.00; 2-yr. heads, \$2.50.

Flowering Crab - Malus

The Flowering Crabs are slow growing trees with fragrant blossoms from pure white to deep red. Ideal trees for garden border or single specimens.

The following varieties, 2 to 3 ft., 75c each;
3 to 4 ft., \$1.00 each; 4 to 5 ft., \$1.25 each;
5 to 6 ft., \$2.00 each; 6 to 7 ft., \$2.50 each.

Bechtels Crab (*M. ioensis plena*). Double pink in clusters.

Carmine Crab (*M. atrosanguinea*). Brilliant carmine.

Japanese Crab (*M. floribunda*). Pinkish buds, white flowers.

Parkman Crab (*M. halliana parkmani*). Double rose-red.

Redvein Crab (*M. niedzwetzkyana*). Early flowering red.

Dogwood - Cornus

Redflowering Dogwood (*C. florida rubra*). 3 to 4 ft., \$2.00 each; 4 to 5 ft., \$2.75 each; 5 to 6 ft., \$4.00 each; 6 to 7 ft., \$6.00 each.

Whiteflowering Dogwood (*C. florida*). 3 to 4 ft., \$1.00 each; 4 to 5 ft., \$1.50 each; 5 to 6 ft., \$2.50 each; 6 to 8 ft., \$3.50 each; 8 to 10 ft., \$5.00 each.

Elm - Ulmus

American Elm (*U. americana*). 6 to 8 ft., \$1.25 each; 8 to 10 ft., \$1.75 each; 10 to 12 ft., \$2.00 each.

Chinese Elm (*U. pumila*). 5 to 6 ft., \$1.00 each; 6 to 8 ft., \$1.50 each; 8 to 10 ft., \$2.00 each; 10 to 12 ft., \$2.50 each.

Moline Elm (*U. americana moline*). A large, fast growing tree with handsome foliage. 6 to 8 ft., \$1.50 each; 8 to 10 ft., \$2.50 each; 10 to 12 ft., \$3.50 each.

Hawthorn - Crataegus

Scarlet Hawthorn (*C. oxyacantha pauli*). 3 to 4 ft., \$1.50 each; 4 to 5 ft., \$1.75 each; 5 to 6 ft., \$2.00 each.

White Hawthorn (*C. oxyacantha alba*). 3 to 4 ft., \$1.50 each; 4 to 5 ft., \$1.75 each; 5 to 6 ft., \$2.00 each.

Judas-Tree - Cercis

Redbud or Judas-tree (*C. canadensis*). 4 to 5 ft., \$1.50 each; 5 to 6 ft., \$2.00 each.

Linden - Tilia

American Linden (*T. platyphyllos*). 6 to 8 ft., \$2.00 each.

European Linden (*T. vulgaris*). 6 to 8 ft., \$2.50 each; 8 to 10 ft., \$3.00 each.

Maidenhair-Tree - Ginkgo

Maidenhair-tree (*G. biloba*). Fan-shaped foliage, resembling the Maidenhair Fern. Very ornamental. 6 to 8 ft., \$3.50 each; 8 to 10 ft., \$4.50.

Magnolia

Soulangeana (*Saucer Magnolia*). 2 to 3 ft., \$3.00 each; 3 to 4 ft., \$4.00 each; 4 to 5 ft., \$6.00 each.

Stellata. 18 to 24 in., \$3.50 each; 2 to 2½ ft., \$4.50 each.

Maple - Acer

Norway Maple (*A. platanoides*). 6 to 8 ft., \$1.25 each; 8 to 10 ft., \$1.50 each; 10 to 12 ft., \$2.00 each; 12 to 14 ft., \$3.00 each.

Rock Maple (*A. saccharum*). 8 to 10 ft., \$1.50 each; 10 to 12 ft., \$2.50 each; 12 to 14 ft., \$3.50; 14 to 16 ft., \$4.50.

Schwedleri Maple (*A. schwedleri*). Purplish foliage. A very desirable lawn tree. 6 to 8 ft., \$1.75 each; 8 to 10 ft., \$2.50 each; 10 to 12 ft., \$3.50.

Silver Maple (*A. dasycarpum*). A rapid growing tree for lawn or street planting. 6 to 8 ft., \$1.00 each; 8 to 10 ft., \$1.25 each; 10 to 12 ft., \$1.50 each.

Wier's Cutleaved Weeping Maple (*A. dasycarpum wieri*). A graceful, drooping tree of rapid growth; ideal as a lawn specimen. 6 to 8 ft., \$1.00 each; 8 to 10 ft., \$1.50 each; 10 to 12 ft., \$2.25 each; 12 to 14 ft., \$3.00 each.

Bloodleaved Japan Maple (*A. palmatum atropurpureum*). Very dwarf; deep blood red foliage. 15 to 18 in., \$2.00 each; 18 to 24 in., \$2.50 each; 2 to 2½ ft., \$4.00 each.

Mountain-Ash (Sorbus)

European Mountain-Ash (*S. aucuparia*). White flowers in May; clusters of orange-red berries in autumn; medium growth. 6 to 8 ft., \$1.50 each; 8 to 10 ft., \$2.00 each; 10 to 12 ft., \$3.00 each.

Mulberry (Morus)

Teas' Weeping Mulberry (*M. tatarica pendula*). A dwarf weeping tree with long, pendulous branches which droop to the ground. \$2.50 each.

Oak - Quercus

Pin Oak (*Q. palustris*). Pyramidal habit, deeply cut leaves. 6 to 8 ft., \$2.25 each; 8 to 10 ft., \$3.00 each; 10 to 12 ft., \$4.00 each.

Red Oak (*Q. rubra*). 6 to 8 ft., \$3.00 each.

Poplar - Populus

Carolina Poplar (*P. deltoides*). Tall and spreading, rapid growth. 6 to 8 ft., 75c each; 8 to 10 ft., \$1.00 each; 10 to 12 ft., \$1.50 each.

Lombardy Poplar (*P. nigra italica*). A tree of rapid growth, useful for screening. The trees which we offer are bushy and the branches start from the ground. 6 to 8 ft., 60c each, \$6.00 per doz.; 8 to 10 ft., 75c each, \$8.50 per doz.; 10 to 12 ft., \$1.00 each, \$11.00 per doz.; 12 to 14 ft., \$1.50 each, \$15.00 per doz.

Willow - Salix

Golden Bark Willow (*S. vitellina aurea*). 5 to 6 ft., 75c each; 6 to 8 ft., \$1.00 each; 8 to 10 ft., \$1.25 each.

Laurel-leaved Willow (*S. pentandra*). 4 to 5 ft., 75c each; 5 to 6 ft., \$1.00 each; 6 to 8 ft., \$1.25 each.

Thurlow's Willow (*S. elegantissima*). 6 to 8 ft., \$1.25 each; 8 to 10 ft., \$1.75 each; 10 to 12 ft., \$2.00 each.

Wisconsin Weeping Willow (*S. blanda*). 6 to 8 ft., \$1.00 each; 8 to 10 ft., \$1.50 each.



Lombardy Poplar

Hardy Climbing Plants and Flowering Vines

ACTINIDIA arguta. Oval, glossy leaves and clusters of fragrant flowers	Each	Doz.
	\$0.75	\$ 7.50
AKEBIA quinata. Clover-like leaves and fragrant, velvety purple flowers75	7.50
AMPELOPSIS quinquefolia (Virginia Creeper). Rapid grower50	5.00
engelmanni. A creeper that clings to stone or wood as tightly as English Ivy50	5.00
veitchi (Japanese or Boston Ivy). Very fine for covering walls, rocks, etc.50	5.50
Pot-grown, ready May 15	1.00	11.00
ARISTOLOCHIA siphon (Dutchmans-pipe). Heart-shaped leaves; the brown flowers resemble a pipe	1.00	10.00
BIGNONIA radicans (Trumpetflower). Large trumpet-shaped, orange and red flowers ..	.60	6.00
CELASTRUS orbiculatus (Japanese Bittersweet). A strong climbing shrub with glossy green foliage, and in autumn covered with bright yellow fruit50	5.00
scandens (Roxbury Waxwork). Glossy leaves and clusters of orange-crimson fruit, which remains on all winter50	5.00
CLEMATIS paniculata. Glossy, dark green foliage, and covered in the latter part of the summer with star-like white flowers, fragrant35	3.75
Extra large50	5.50
Pot-grown, ready May 1575	8.25
henryi. One of the best whites; very large white flowers often as much as 8 inches across. A continuous bloomer	1.00	10.00
jackmani. Large violet-purple; free bloomer.	1.00	10.00
Mme. Edouard Andre. Large carmine-red flowers; very free bloomer	1.00	10.00
ENGLISH IVY (<i>Hedera helix</i>). A very desirable evergreen climber, succeeds best in a sheltered, shady situation50	5.00
LONICERA (Honeysuckle). Old favorites, shrubby climbers, fine for porches and trellises. Very fragrant.		
Hall's Japan. Fragrant, yellow and cream-colored flowers all summer40	4.50
Pot-grown, ready May 1575	8.25
Scarlet Trumpet. Clusters of tubular scarlet flowers all summer50	5.50
HOP VINE. Vigorous and quick growing twiner, for covering arbors, etc.50	5.00



Hall's Japan Honeysuckle

	Each	Doz.
LYCIUM chinense (Matrimony-vine). A climbing shrub with light green foliage and pale purple flowers; fine for northern exposures	\$0.50	\$ 5.00
POLYGONUM auberti (Silver Lace Vine). A very strong growing, decorative climbing plant, staying in bloom through the summer and autumn. The flowers are in large sprays of pure white75	7.50
WISTERIA sinensis (Chinese Wisteria). Long, pendulous clusters of pale blue75	7.50
sinensis alba. White-flowered75	7.50

Hedge Plants

BARBERRY thunbergi or Japanese.	Doz.	100
12 to 15 in.	\$1.25	\$ 8.50
15 to 18 in.	1.75	12.00
18 to 24 in.	2.50	18.00
24 to 30 in.	4.00	30.00
PRIVET, Amur River.		
18 to 24 in.	1.75	12.00
24 to 36 in.	2.00	15.00
California.		
18 to 24 in.75	4.50
24 to 36 in.	1.00	7.00
36 to 48 in.	1.75	10.00
Ibota.		
18 to 24 in.	1.75	12.00
24 to 36 in.	2.00	15.00
36 to 48 in.	3.00	20.00

	Doz.	100
Ibodium. A cross between Ibota and California Privet. It has the attractive dark green leaves of the California, but is of a more branching habit, making a more compact hedge in less time. The best of all Privets.		
18 to 24 in.	\$1.00	\$ 7.00
24 to 36 in.	1.50	10.00
36 to 48 in.	2.00	13.00
LILAC, Common. Purple. 2 to 3 ft.	4.00	25.00
White. 18 to 24 in.	4.00	25.00
White. 2 to 3 ft.	6.00	40.00
SPIREA vanhouttei.		
2 to 3 ft.	3.50	25.00
ARBOR-VITAE, American.		
2 to 3 ft.	10.00	75.00
HEMLOCK.		
1 1/2 to 2 ft.	11.00	80.00
SPRUCE, Norway.		
2 to 3 ft.	9.50	65.00

Evergreen Trees

Arborvitae - Thuja

American Arborvitae (*T. occidentalis*). The common upright variety used as single specimens and for hedges. 2 to 3 ft., 90c each; 3 to 4 ft., \$1.50 each; 4 to 5 ft., \$1.75 each; 5 to 6 ft., \$3.00 each; 6 to 7 ft., \$4.00 each; 7 to 8 ft., \$6.50 each; 8 to 9 ft., \$8.00 each; 9 to 10 ft., \$10.00 each.

Dark American Arborvitae (*T. occidentalis nigra*). A newer variety with foliage much darker than the American and hardier. 2 to 3 ft., \$1.75 each; 3 to 3½ ft., \$2.25 each; 3½ to 4 ft., \$3.00; 4 to 5 ft., \$5.00 each; 5 to 6 ft., \$6.00 each.

George Peabody Arborvitae (*T. occidentalis lutea*). Similar to the American in habit; foliage golden yellow. 3 to 4 ft. \$2.50 each; 4 to 5 ft., \$3.00 each.

Globe Arborvitae (*T. occidentalis globosa*). Round, compact form with dense foliage; dwarf. 12 to 15 in., 75c each; 15 to 18 in., \$1.00 each; 18 to 24 in., \$1.25 each; 2 to 2½ ft., \$1.75 each.

Little Gem Arborvitae (*T. occ. Little Gem*). One of the few Arbor-Vitae which is a true dwarf. The foliage is dark green. An ideal dwarf evergreen for the rock garden. 6 to 8 in., \$1.00.

Pyramidal Arborvitae (*T. occidentalis pyramidalis*). A most valuable upright evergreen of dense, compact habit. Foliage dark green. 2 to 3 ft., \$1.25; 3 to 4 ft., \$1.50; 4 to 5 ft., \$2.50; 5 to 6 ft., \$3.25; 6 to 7 ft., \$4.50; 7 to 8 ft., \$7.00.

Rosenthal Arborvitae (*T. occidentalis Rosenthal*). One of the best of the pyramid type. It makes a compact, broad, symmetrical pyramid and is very useful for formal plantings and specimens. The foliage, which is a lustrous, dark green, retains its color throughout the entire winter. 2 to 2½ ft., \$3.00 each; 2½ to 3 ft., \$3.50 each; 3 to 3½ ft., \$4.00 each; 3½ to 4 ft., \$4.50 each; 4 to 5 ft., \$5.00 each; 5 to 6 ft., \$6.50 each.

Siberian Arborvitae (*T. occidentalis wareana*). A very hardy variety holding its dark green color throughout the entire year; low and bushy in habit. 18 to 24 in., \$1.25 each; 2 to 2½ ft., \$2.00 each; 2½ to 3 ft., \$3.00 each.

Vervaene Arborvitae (*T. occidentalis vervaeneana*). The foliage shows a little golden tinge; densely branched and of columnar habit. 1½ to 2 ft., \$1.00 each; 2 to 3 ft., \$1.50 each; 3 to 4 ft., \$2.50 each; 4 to 5 ft., \$3.50 each; 5 to 6 ft., \$5.00 each.

Fir - Abies

Fraser Fir (*A. fraseri*). A compact pyramidal grower. The foliage, which is fragrant, is a lustrous, dark green and is a bluish-white beneath. Resembles closely the Balsam fir. 2 to 2½ ft., \$2.00 each; 2½ to 3 ft., \$3.00 each; 3 to 4 ft., \$4.00 each; 4 to 5 ft., \$5.00 each.

Nikko Fir (*A. homolepis*) (*Brachyphylla*). This is a tall growing tree from the mountains of central Japan. The dark green leaves are silvery white beneath. A handsome lawn tree. 2 to 2½ ft., \$2.00 each; 2½ to 3 ft., \$2.50 each; 3 to 4 ft., \$3.00 each; 4 to 5 ft., \$4.00 each.



Pfitzer Juniper

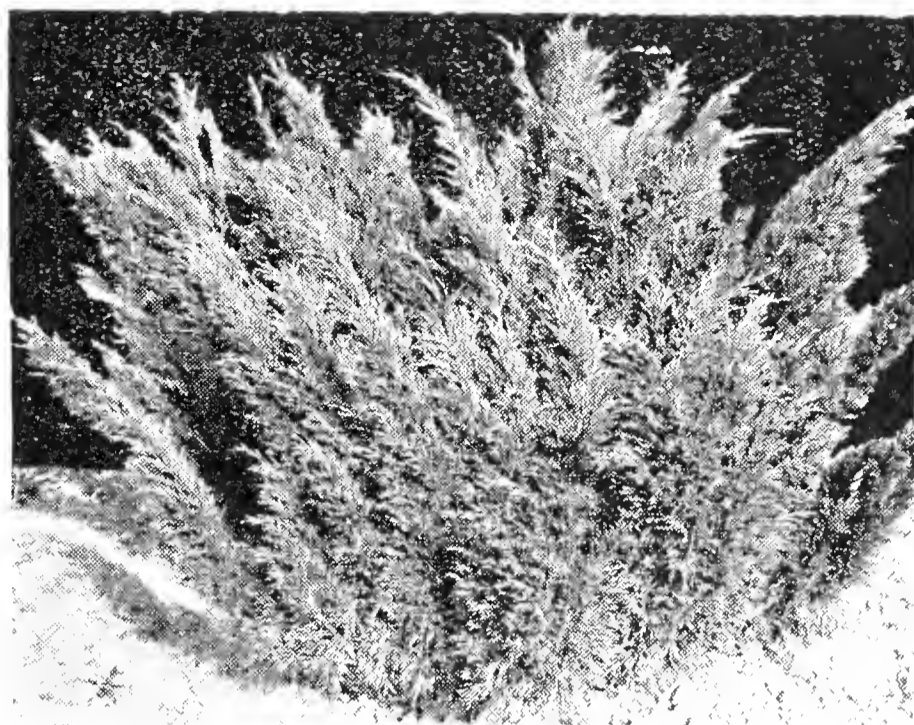

Savin Juniper

Veitch Fir (*A. veitchi*). The most rapid growing of all the Firs. Symmetrical in shape with dark green foliage, silvered on the under side. 2 to 2½ ft., \$2.50 each; 2½ to 3 ft., \$3.50 each; 3 to 4 ft., \$4.00 each; 4 to 5 ft., \$5.00.

White Fir (*A. concolor*). A rapid growing tree of majestic proportions when mature. The color varies from a light green to almost blue. One of our finest specimen lawn trees. 2 to 2½ ft., \$2.50 each; 2½ to 3 ft., \$3.25 each; 3 to 4 ft., \$4.00 each; 4 to 5 ft., \$5.00 each.

Douglas Fir (*Pseudotsuga douglasi*). Large, very rapid growing tree forming a dense pyramid. The foliage is a soft bluish green. 2 to 3 ft., \$2.00 each; 3 to 4 ft., \$2.50 each; 4 to 5 ft., \$3.00 each; 5 to 6 ft., \$4.00 each.

Hemlock - Tsuga

Canadian Hemlock (*T. canadensis*). A medium sized tree of dense growth with rich green foliage; branches droop gracefully. 18 to 24 in., \$1.00 each; 2 to 2½ ft., \$1.60 each; 2½ to 3 ft., \$2.00 each; 3 to 4 ft., \$2.50 each; 4 to 5 ft., \$3.50 each; 5 to 6 ft., \$5.00 each.

Juniper - Juniperus

Chinese Juniper (*J. chinensis*). Pyramidal in outline, with silvery green foliage. 2 to 2½ ft., \$2.50 each; 2½ to 3 ft., \$3.00 each; 3 to 4 ft., \$4.50 each.

Greek Juniper (*J. excelsa stricta*). A very symmetrical dwarf evergreen of conical shape; bluish green. 12 to 18 in., \$1.50 each; 18 to 24 in., \$2.25 each; 2 to 2½ ft., \$3.00 each.

Irish Juniper (*J. communis hibernica*). Slender and columnar in habit with bluish green foliage. 1½ to 2 ft., \$1.00 each; 2 to 3 ft., \$1.50 each; 3 to 3½ ft., \$2.00 each; 3½ to 4 ft., \$2.50 each.

Pfitzer Juniper (*J. chinensis pfitzeriana*). A most valuable foundation evergreen. Dwarf in habit, its bluish green foliage is carried on graceful spreading branches; thrives under very unfavorable conditions. 18 to 24 in. spread, \$1.65 each; 2 to 2½ ft., \$2.00 each; 2½ to 3 ft., \$3.00 each.

Red Cedar (*J. virginiana*). A native Cedar of pyramidal shape with foliage varying from bright green in summer to a bronzy hue in winter. Useful for formal effect. 6 to 7 ft., \$5.00 each; 7 to 8 ft., \$6.50; 8 to 9 ft., \$9.00 each.

Savin Juniper (*J. sabina*). Beautiful dark green foliage, with fan-shaped branches. Very hardy. 15 to 18 in., \$1.25 each; 18 to 24 in., \$1.50 each; 24 to 30 in., \$2.50 each; 2½ to 3 ft., \$3.25 each; 3 to 3½ ft., \$4.00 each.

Spreading Juniper (*J. communis*). A very hardy trailing type with bluish foliage; valuable for rock planting. 2 to 2½ ft., \$2.50 each.

Swedish Juniper (*J. communis suecica*) Very similar to the Irish Juniper, but much hardier. 2 to 2½ ft., \$1.50 each; 2½ to 3 ft., \$2.00 each; 3 to 4 ft., \$2.50 each; 4 to 5 ft., \$3.00 each.

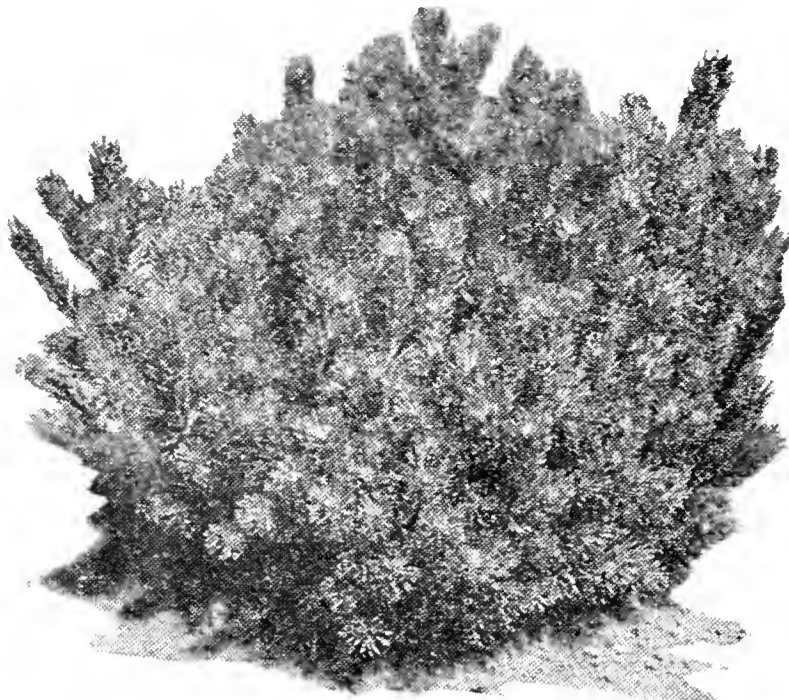

Dwarf Mugho Pine

Pine - Pinus

Austrian Pine (*P. nigra*). A tree of rapid growth with long dark green foliage. A vigorous and rugged grower even under unfavorable conditions. 2 to 3 ft., \$2.50 each; 3 to 4 ft., \$3.50 each; 4 to 5 ft., \$4.50 each; 5 to 6 ft., \$6.00 each.

Dwarf Mugho Pine (*P. montana mughus*). Foliage dark green; very dwarf in habit; very useful as a border or rock plant. 12 to 15 in., \$1.00 each; 15 to 18 in., spread, \$1.35 each; 18 to 24 in., spread, \$1.50 each; 2 to 2½ ft., \$3.00 each; 2½ to 3 ft., \$4.00 each.

Red Pine (*P. resinosa*). A vigorous grower with long, rich green needles. 2 to 3 ft., \$1.00 each; 3 to 4 ft., \$2.00 each; 4 to 5 ft., \$3.00 each; 5 to 6 ft., \$4.50 each.

Scotch Pine (*P. sylvestris*). A tree of rapid growth with short, stiff, bluish green foliage. 2 to 3 ft., \$1.00 each; 3 to 4 ft., \$1.75 each; 4 to 5 ft., \$2.50 each.

White Pine (*P. strobus*). A lofty native tree. Silvery green foliage. Does well on sandy soil. 2 to 3 ft., \$1.00 each; 3 to 4 ft., \$2.00 each; 4 to 5 ft., \$3.00 each; 5 to 6 ft., \$4.50 each; 6 to 7 ft., \$7.00 each; 7 to 8 ft., \$8.00 each; 8 to 10 ft., \$10.00 each.

Retinospora (Japan Cypress) - Chamaecyparis

Plume Cypress (*R. plumosa*). Erect branches with side shoots of a plume-like arrangement; graceful, feathery, green foliage, 1½ to 2 ft., \$1.25 each; 2 to 2½ ft., \$1.50 each; 2½ to 3 ft., \$1.75 each; 3 to 4 ft., \$2.50 each.

Golden Plume Cypress (*R. plumosa aurea*). A golden form. 1½ to 2 ft., \$1.25 each; 2 to 2½ ft., \$1.50 each; 2½ to 3 ft., \$1.75 each; 3 to 4 ft., \$2.50 each.

Sawara Cypress (*R. pisifera*). An upright, graceful tree with flattened branchlets; foliage green. 1½ to 2 ft., \$1.00 each; 2 to 2½ ft., \$1.50 each; 2½ to 3 ft., \$1.75 each; 3 to 3½ ft., \$2.50 each; 3½ to 4 ft., \$3.50 each.

Thread Cypress (*R. filifera*). The long, thread-like branches are very pendulous; lateral stems of bright green. 18 to 24 in., \$2.00 each; 2 to 3 ft., \$2.50 each; 3 to 4 ft., \$4.00 each; 4 to 5 ft., \$5.50 each.

Spruce - Picea

Colorado Green Spruce (*P. pungens*). A stately evergreen of symmetrical habit, having sharp, dull green needles on horizontal branches. 2½ to 3 ft., \$2.00 each; 3 to 4 ft., \$2.50 each; 4 to 5 ft., \$3.00 each; 5 to 6 ft., \$4.00 each.

Colorado Blue Spruce (*P. pungens glauca*). The well known Colorado Blue Spruce. 18 to 24 in., \$2.00 each; 2 to 2½ ft., \$3.50 each; 2½ to 3 ft., \$4.50 each; 3 to 4 ft., \$5.50 each; 4 to 5 ft., \$7.50 each; 5 to 6 ft., \$10.00 each.

Koster's Blue Spruce (*P. pungens kosteri*). The bluest of all the Spruces. 2 to 2½ ft., \$5.00 each; 2½ to 3 ft., \$6.00 each; 3 to 3½ ft., \$7.50 each; 3½ to 4 ft., \$10.00 each; 4 to 4½ ft., \$12.50 each; 4½ to 5 ft., \$14.00 each; 5 to 6 ft., \$15.00 each; 6 to 7 ft., \$20.00 each.

Dwarf Alberta Spruce (*P. glauca conica*). A beautiful, compact cone-shaped evergreen with dense foliage. Dwarf. 12 to 15 in., \$2.00 each; 15 to 18 in., \$3.00 each.

Norway Spruce (*P. excelsa*). 1½ to 2 ft., 60c each; 2 to 3 ft., 85c each; 3 to 4 ft., \$1.25 each; 4 to 5 ft., \$2.00 each; 5 to 6 ft., \$3.50 each.

Pygmy Spruce (*P. excelsa pygmaea*). This little tree of dwarf and compact habit makes an ideal plant for rockeries. 6 to 8 in., \$1.25 each; 8 to 10 in., \$1.50 each; 10 to 12 in., \$2.00 each.

White Spruce (*P. canadensis*). An upright grower with light silvery green foliage 12 to 18 in., 60c each; 18 to 24 in., 85c; 2 to 3 ft., \$1.00; 3 to 4 ft., \$1.50; 4 to 5 ft., \$2.50; 5 to 6 ft., \$4.00.

Yew - Taxus

Canadian Yew (*T. canadensis*). Low, spreading shrub with pale green foliage. Preferable for shady plantings. 15 to 18 in., \$1.50 each; 18 to 24 in., \$2.25 each.

Columnar Yew (*T. cusp. int. columnaris*). This variety grows extremely upright and narrow like the Irish Juniper and can be used in many places where a narrow tree is desired. 15 to 18 in., \$1.50 each; 18 to 24 in., \$2.00 each; 2 to 2½ ft., \$2.50 each; 2½ to 3 ft., \$3.50 each; 3 to 3½ ft., \$5.00 each; 3½ to 4 ft., \$7.50 each.

Dwarf Hedge Yew (*T. canadensis stricta*). Especially adapted for a dwarf edging for gardens or border plantings. 8 to 10 in., 75c each; 10 to 12 in., \$1.00 each; 12 to 15 in., \$2.00 each; 15 to 18 in., \$3.00 each.

Japanese Yew (*T. cuspidata*). One of the most desirable of the low growing evergreens. The foliage is dark green; spreading habit and very hardy. 15 to 18 in., \$1.50 each; 18 to 24 in., \$2.25 each; 2 to 2½ ft., \$3.25 each; 2½ to 3 ft., \$4.50 each; 3 to 3½ ft., \$7.50 each; 3½ to 4 ft., \$10.00 each.

Upright Japanese Yew (*T. cuspidata capitata*). An upright form of the above. 15 to 18 in., \$1.50 each; 18 to 24 in., \$2.50 each; 2 to 2½ ft., \$3.50 each; 2½ to 3 ft., \$5.00 each; 3 to 3½ ft., \$7.00 each; 3½ to 4 ft., \$9.00 each.

Intermediate Japanese Yew (*T. cuspidata intermedia*). The habit of growth is more dense and the foliage darker than the Japanese. 12 to 15 in., \$2.00 each; 15 to 18 in., \$2.50 each; 18 to 24 in., \$3.50 each.

Dwarf Japanese Yew (*T. cuspidata nana brevifolia*). An excellent dwarf variety with very dark green foliage. 12 to 15 in., \$2.00 each; 15 to 18 in., \$2.50 each; 18 to 21 in., \$3.75 each; 21 to 24 in., \$6.00 each.

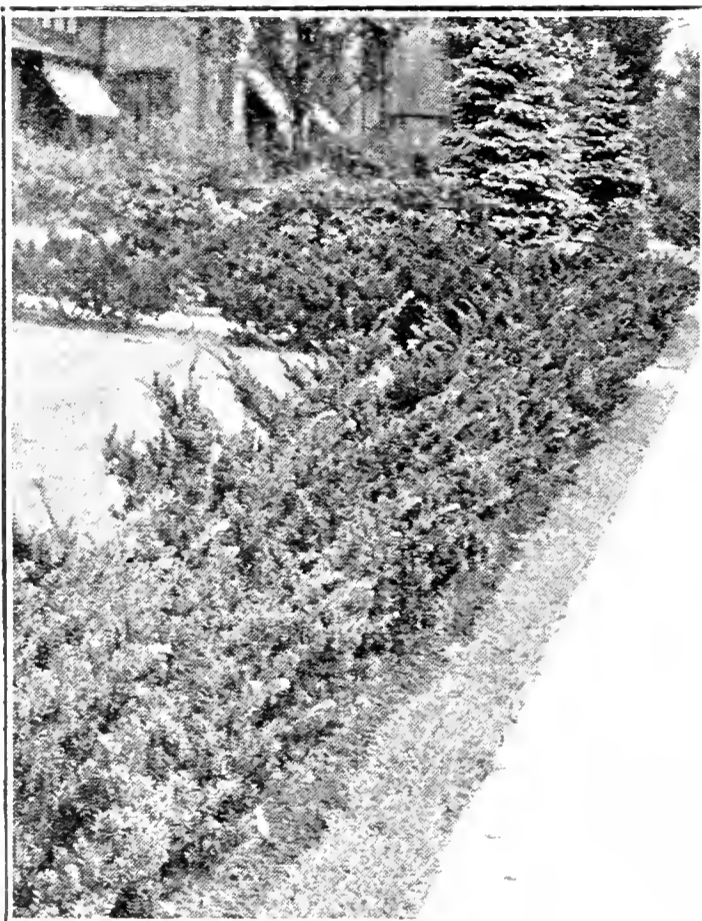

Dwarf Japanese Yew



Retinospora plumosa aurea

Evergreen Shrubs

These splendid plants hold their rich green foliage all the year round, and in many varieties make a magnificent showing of bloom. Shaded situations are preferred by most of the varieties.

ANDROMEDA (*Pieris*) **floribunda** (Lily-of-the-valley Shrub). Beautiful, hardy shrub. In early April it is covered with showy spikes of white flowers. 12 to 15 in., \$1.75 each; 15 to 18 in., \$2.25 each.

DAPHNE **cneorum** (Rose Daphne). A most attractive, dwarf, almost prostrate shrub. In May, and again in August, it bears beautiful flower clusters of a delightful shade of pink. For rock gardens it is very desirable. 5 to 7 in., 50c each; \$5.50 per doz.; 7 to 9 in., 60c each; \$6.50 per doz.; 9 to 12 in., 80c each; \$9.00 per doz.; 12 to 15 in., \$1.00 each; \$11.00 per doz.; 15 to 18 in., \$1.50 each; \$16.50 per doz.

EUONYMUS **radicans**. Very hardy, dense-growing trailing vine; dull green leaves, with whitish veins; grows rapidly; self-clinging. 40c each; \$4.00 per doz.; \$30.00 per 100.

radicans variegata. Similar in habit to the above. Foliage green and white. 40c each, \$4.00 per doz.

r. kewensis. The smallest *Euonymus*. The leaves are about $\frac{1}{4}$ inch wide and a little longer. As a low evergreen ground-cover it forms a perfect mat of green. A fine variety for the rock garden, low walls, low slopes and edge of pools. 3-yr., 35c each; \$3.50 per doz. 4-yr., 40c each; \$4.00 per doz.

r. vegetus. A pretty, low trailing evergreen with aerial rootlets which cling to any support. Has round leaves and produces an abundance of showy red fruits with yellow pods. 2-yr., 35c each; \$3.50 per doz.; \$28.00 per 100. 3-yr. 50c each; \$5.00 per doz.; \$35.00 per 100.

HEATHER (*Calluna vulgaris*). The Heathers are compact, low-growing plants, and as such are extremely useful for rockeries. The small foliage is densely arranged around the wiry little stems, and either when in full bloom or in midwinter makes a very pretty picture. 6 to 8 in., 50c each; 8 to 10 in., 75c each.

LEUCOTHOE (*Andromeda*) **catesbaei**. A valuable shrub in shady positions. Flowers are fine, white, and are borne in long, pendulous racemes. 12 to 18 in., \$1.50 each; 18 to 24 in., \$2.00 each.

MOUNTAIN LAUREL (*Kalmia latifolia*). Grows 8 ft. high, with broad, glossy green foliage. The rose colored flowers, in large and showy clusters at the ends of the shoots, appear in June. 15 to 18 in., \$1.50 each; 18 to 24 in., \$2.00 each; 2 to 2½ ft., \$3.00 each; 2½ to 3 ft., \$4.00 each.

PACHYSANDRA **terminalis** (Japanese Spurge). The best ground cover under shrubs of all kinds. Grows only 6 in. high and has dark green foliage. 25c each; \$2.50 per doz.; \$18.00 per 100.

RHODODENDRON **carolinianum** (Carolina Rhododendron). Leaves rather small, narrow, dark green above, covered with brownish dots beneath; clusters of clear rose-pink flowers in May; very hardy. 12 to 15 in., \$1.25 each; 15 to 18 in., \$1.75 each; 18 to 24 in., \$2.25 each.

White Carolina, 12 to 18 in., \$2.50 each.

catawbiense (Catawba Rhododendron). One of the most beautiful native shrubs and the hardiest of all the Rhododendrons. Color, rosy purple. 12 to 15 in., \$1.75 each; 15 to 18 in., \$2.00 each; 18 to 24 in., \$2.50 each; 2 to 2½ ft., \$3.50 each; 2½ to 3 ft., \$4.50 each.

c. compacta, 12 to 15 in., \$2.75 each; 15 to 18 in., \$3.50 each; 18 to 24 in., \$4.50 each.

maximum (Great Laurel). A well known native of our mountain regions, with great clusters of white or rose-pink flowers in June and July. 15 to 18 in., \$1.75 each; 18 to 24 in., \$2.00 each; 2 to 2½ ft., \$2.75 each; 2½ to 3 ft., \$3.50 each.

VINCA MINOR (Myrtle or Common Periwinkle). A handsome evergreen trailing plant with showy bright blue flowers borne freely in early spring. A good shade-growing ground-cover plant. 25c each, \$2.50 per doz., \$15.00 per 100. Pot grown.

YUCCA **filamentosa** (Adams Needle). Handsome, creamy white flowers, much branched and densely packed with bloom, with swordlike foliage. 40c each.

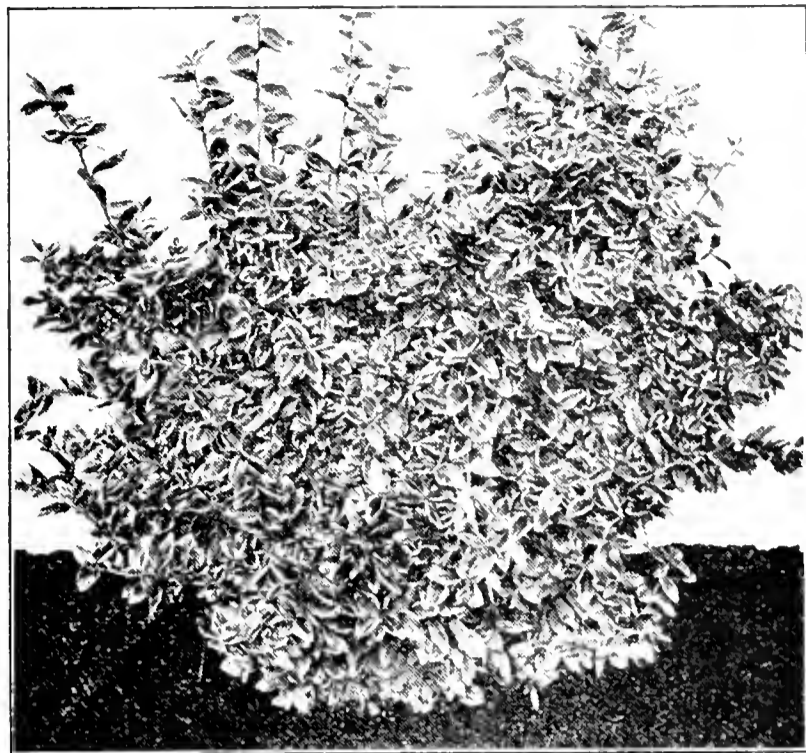

Euonymus Radicans Variegata

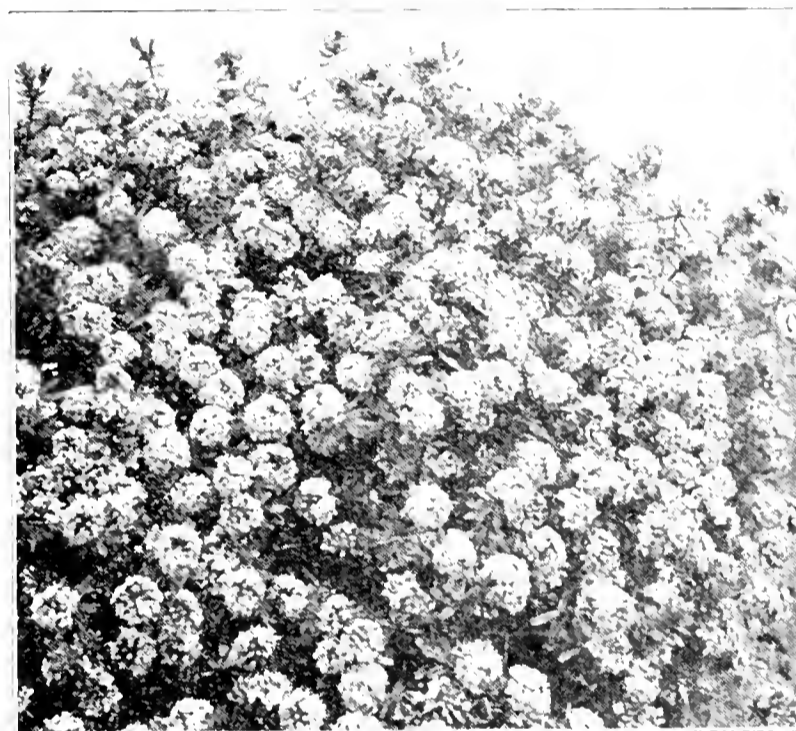

Daphne Cneorum



Rhododendron

Fruit Trees

Apples

(STANDARD)

Each Doz.

2-yr., 6 to 7 ft.\$1.00 \$10.00

SUMMER VARIETIES

Red Astrachan. Red, large. Aug.
Sweet Bough. Pale yellow, large. Aug.

AUTUMN APPLES

Fameuse, or Snow. Crimson. Nov. to Jan.
Gravenstein. Red striped, large. Oct.
Wealthy. Deep red, white flesh.

WINTER VARIETIES

Baldwin. Red, large.
Cortland. A beautiful red; larger than McIntosh and ripening a month later.
Delicious. Large, red.
McIntosh Red. One of the best, red; Nov., Feb.
Northern Spy. Yellow and red; large.
Rhode Island Greening. Greenish yellow; large.
Roxbury Russet. Medium to large. Dec. to June.
Talman Sweet. Yellow, medium size. Nov. to April.

DWARF APPLES

	\$1.25 each	
Delicious	McIntosh	Wealthy
R. I. Greening	Yellow Transparent	

CRAB APPLES

\$1.00 each, \$10.00 per doz.

Hyslop. Dark crimson; large.
Transcendent. Yellow and red striped; large.

Cherries

\$1.00 each, \$10.00 per doz.

Black Tartarian. Purplish black; large. June.
Early Richmond. A preserving variety.
Gov. Wood. Yellow and red; large. June.
Montmorency. A large, preserving variety.
Napoleon. Yellow and red; large. July.
Windsor. A large, deep colored variety of good flavor.
Yellow Spanish. Pale yellow, red cheek. June.

Pears

5 to 7 ft., \$1.00 each, \$10.00 per doz.

SUMMER VARIETIES

Bartlett. Yellow and large.
Clapp's Favorite. Yellowish green, large.

AUTUMN VARIETIES

Anjou. Greenish yellow. Nov. to Dec.
Beurre Bosc. Russet color; large. \$1.50 each.
Seckel. Yellowish russet; small.
Sheldon. Yellowish russet; medium size.

WINTER VARIETIES

Duchess. Very large, yellow, with a dull red cheek.

DWARF PEARS

\$1.00 each, \$10.00 per doz.

Anjou, Bartlett, Clapp's Favorite, Seckel.

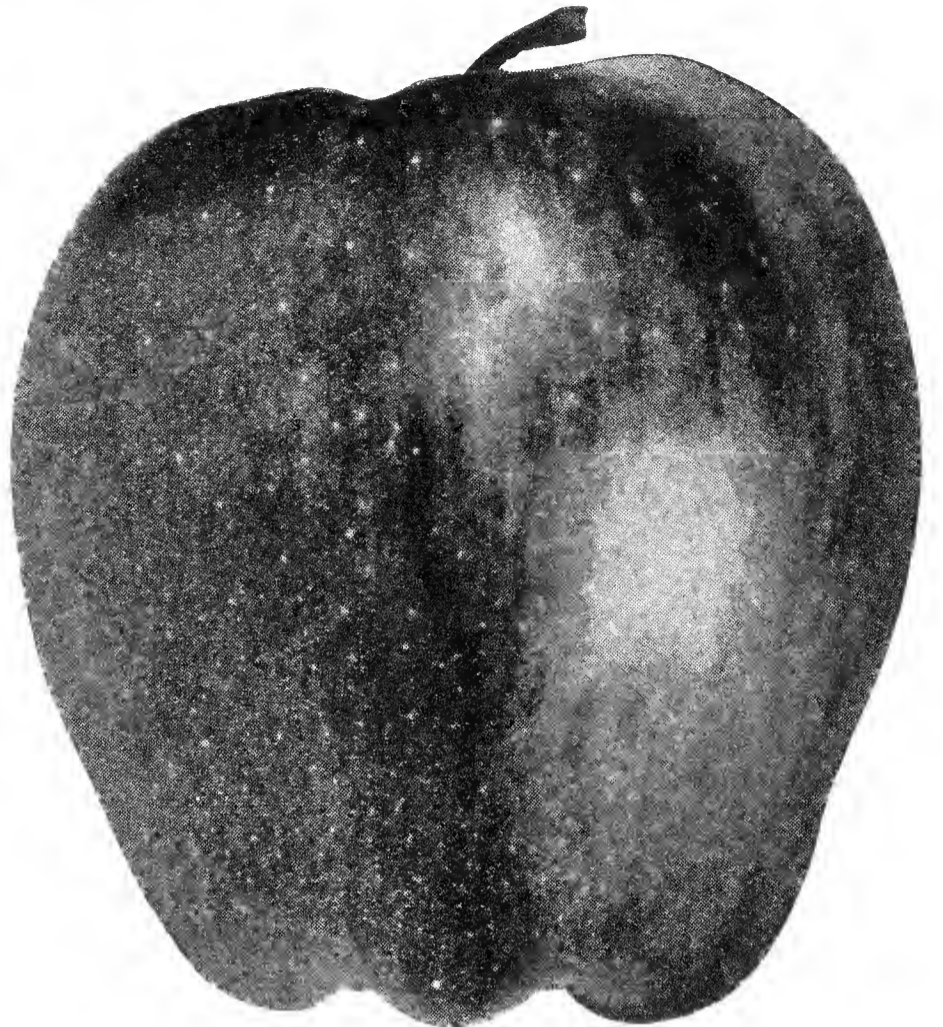

Delicious Apple

Peaches

60c each; \$6.00 per doz.

Belle of Georgia. White, red cheek; large, very late.
Carman. Pale yellow with red blush. Large, with sweet flavor.
Champion. Creamy white, red cheeks; large. Aug. 1.
Crawford's Early. Yellow and red; large. Aug.
Crawford's Late. Yellow and red; large. Sept.
Elberta. Large; light yellow. Aug.
Greensboro. White with red cheek. Early.
J H. Hale. Large, yellow. Freestone. Sept.
Mountain Rose. Large, red, with white flesh; early.
Oldmixon Free. White and red; large. Sept.

Plums

Trees, 5 to 7 ft., \$1.00 each, \$10.00 per doz.

Bradshaw. A very large, oval; dark violet-red; juicy, sweet and good.
Coe's Golden Drop. Very large; light yellow; rather firm; rich, sweet and good; adheres to the stone.
Damson. Last of September. Small, dark purple; valued for preserving.
Lombard. Medium oval; violet-red, juicy, pleasant and good; very productive.

JAPAN PLUMS

Abundance. Lemon-yellow ground, overspread with bright cherry, and a heavy bloom; large.
Burbank. Large and beautiful; clear cherry-red.

Quinces

\$1.25 each

Apple, or Orange. Large, roundish, bright golden yellow; very productive. Early to late.
Champion. Large, yellow, very productive and ripening very late.

Small Fruits

Grapes

35c each, except where noted.

BLACK

Campbell's Early. Very large and sweet; early. 50c each.
Concord. Large, always reliable. Medium.
Moore's Early. Early.
Worden. Large, early.

RED

Brighton. Large, early.
Delaware. Small, delicious. Late.

WHITE

Green Mountain. One of the best. Early.
Moore's Diamond. Early.
Niagara. Medium.

Blackberries

\$1.00 per doz., \$6.00 per 100.

Eldorado. Extra fine and very hardy; large, sweet berry.
Rathbun. Very large, sweet and delicious.
Snyder. Medium size; very fine. Medium.

Raspberries

\$1.00 per doz., \$6.00 per 100.

Columbian. Purple fruit, delicious for table.
Cuthbert. Medium to large, red, sweet.
Latham. Large, deep red, very productive.
St. Regis Everbearing. Large, bright crimson berries.
Herbert. Large, sweet, bright red.

Strawberries

The Strawberry will grow in any good garden soil where the ground has been thoroughly prepared. For family use we recommend planting them in double rows, 1 foot apart each way and 5 feet between the double rows, allowing a sufficient number of runners to grow into the wide passage to cover about 1½ feet on each side; all the rest should be pinched off. It is advisable to cover the plants in winter with litter, which should be removed as soon as the plants commence to grow in spring.

Layer plants in spring, \$3.00 per 100, \$8.00 per 1000, except where noted.

Pot-grown plants after August 1st.

Abington. Strong grower and great yielder. The bright red berries are of very large size, firm and fine flavor. Early to medium.

Arabine. Extra early, very large, bright red of high quality, very robust grower and heavy cropper.

Barrymore. Awarded silver medal and three first premiums by the Massachusetts Horticultural Society, in 1908. A great berry for all purposes. Large size, rich, dark, glossy, crimson color; conical shape; flesh red and quality excellent. Medium.

Big Joe. A magnificent new Strawberry of robust growth and very prolific. The berries are light crimson in color and very large. Medium.

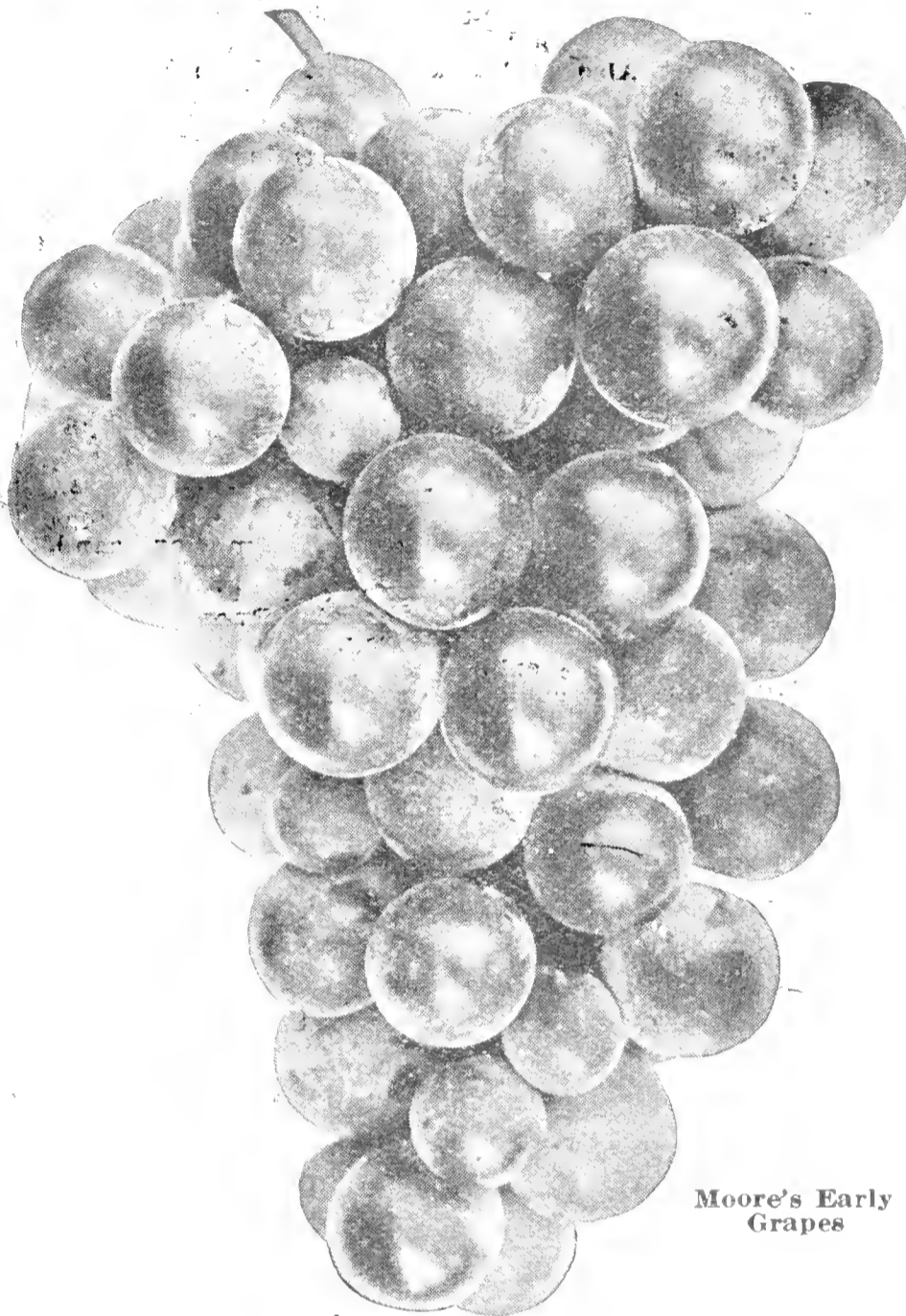

Moore's Early Grapes

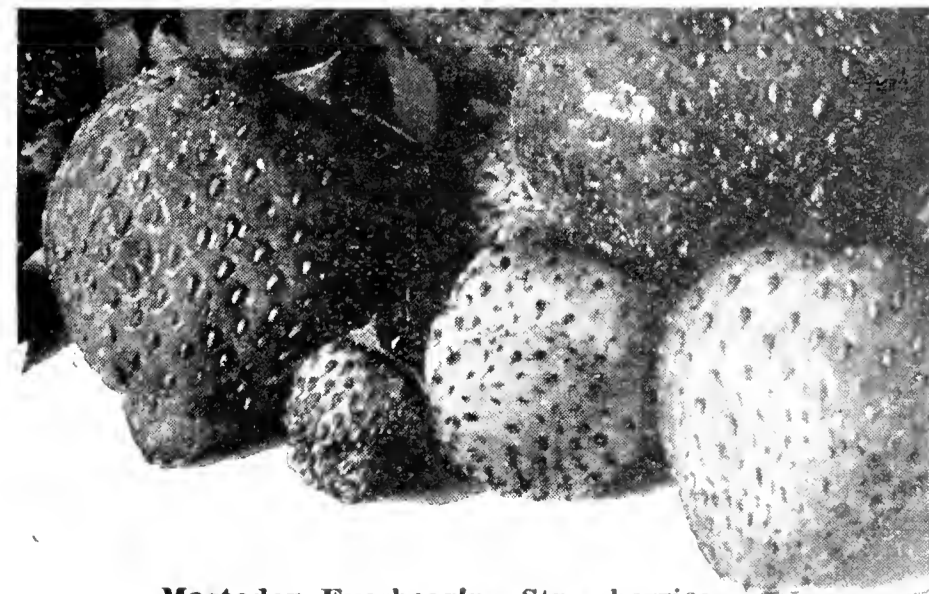

Mastodon Everbearing Strawberries

Brandywine. Large, roundish, conical, bright glossy crimson berries, firm and solid; excellent quality and fine flavor. Medium.

Commonwealth. Large, glossy crimson berry, of excellent quality, a great cropper and one of the latest.

Gibson. Very large, deep red, fine flavor. Medium.

Glen Mary. Very large, highly colored, firm, and ranks with the best in flavor. Medium to late.

Golden Gate. New seedling, resembles the Marshall and will succeed where the Marshall fails. It produces strictly fancy, firm fruit clear to the end of the season, of a rich, crimson color.

Judith. A large, medium red, pointed berry; a good market variety; very early.

Marshall. Large rich crimson, fine flavor. One of the most popular sorts. Medium.

Premier. One of the best of the extra early varieties; does well in almost any section; excellent quality; bright red.

Senator Dunlap. Dark red berries of medium size. The flesh is red all through and exceedingly juicy. Early mid-season.

Warren. Dark, blood red, extra size, broad and flattened at tips, borne on large clusters. Medium.

EVERBEARING STRAWBERRIES

Mastodon. Truly a Wonderberry, in size, flavor and yield. \$4.00 per 100.

Progressive. The fruit is rich and sweet, a deep red inside and out; of good medium size and quite firm. \$3.50 per 100.

Superb. Perfect blossoms. Enormous crops in June, and in September. It does not fruit on new runners. \$3.50 per 100.

All prices subject to change without notice.

Farm, Garden and Lawn Requisites, Tools, Etc.

Asparagus Buncher. Makes bunches of size usually sold in Boston market. \$5.00 each.
Asparagus Knife. Also used as a weeder. 25c to 50c each.
Axes. Warranted steel, Witherell's extra quality, handled. \$2.50 to \$3.50 each.
Bamboo Poles. 20 feet. 50c each, \$5.00 per doz.
Bands, Rubber. For bunching Asparagus, Celery, Beets, Radishes, etc. Used in place of twine or tape. In 1-lb. boxes, \$1.00 per lb.
Bars, Crow. Solid cast steel. Per lb. 15c.

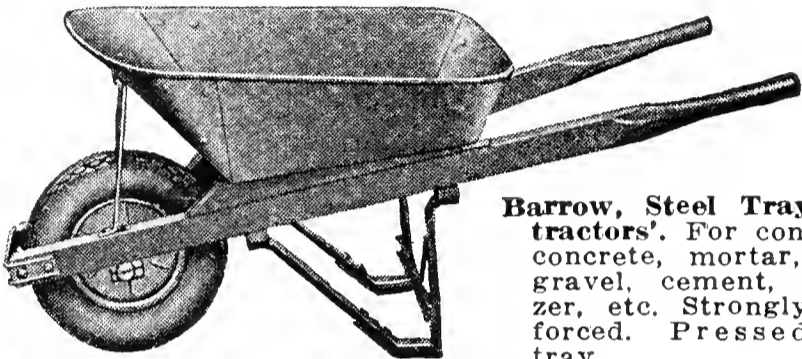

Barrow, Steel Tray Contractors'. For conveying concrete, mortar, sand, gravel, cement, fertilizer, etc. Strongly reinforced. Pressed steel tray.

No. B27—Capacity 3½ cubic feet\$9.00
 No. 21—Capacity, 2½ cubic feet 6.00

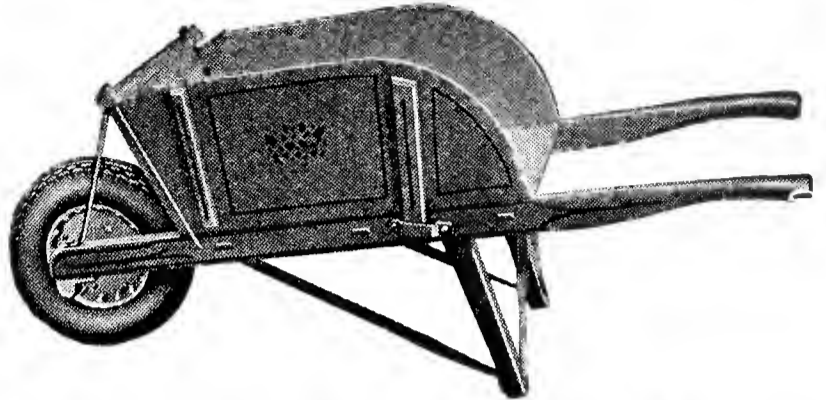

Barrow, New England Garden. This is a strong, well-made barrow; the frame is made from best seasoned timber, nicely painted and striped, it has a six-spoke, steel axle, wood wheel. We consider it the best garden barrow manufactured. Three sizes, No. 64, medium, \$8.00; No. 65, large, \$9.00; No. 66, extra large, \$10.00.

Barrows, equipped with 16x4 inch pneumatic rubber tire wheels, \$8.00 extra.

Barrow, Greenhouse. Made especially for greenhouse. Long narrow bodies with wood wheel, \$10.00.

Barrow Leaf Rack. Made of galvanized wire, with wood bottom, capacity ten bushels. \$10.00.

Shelton's Baskets

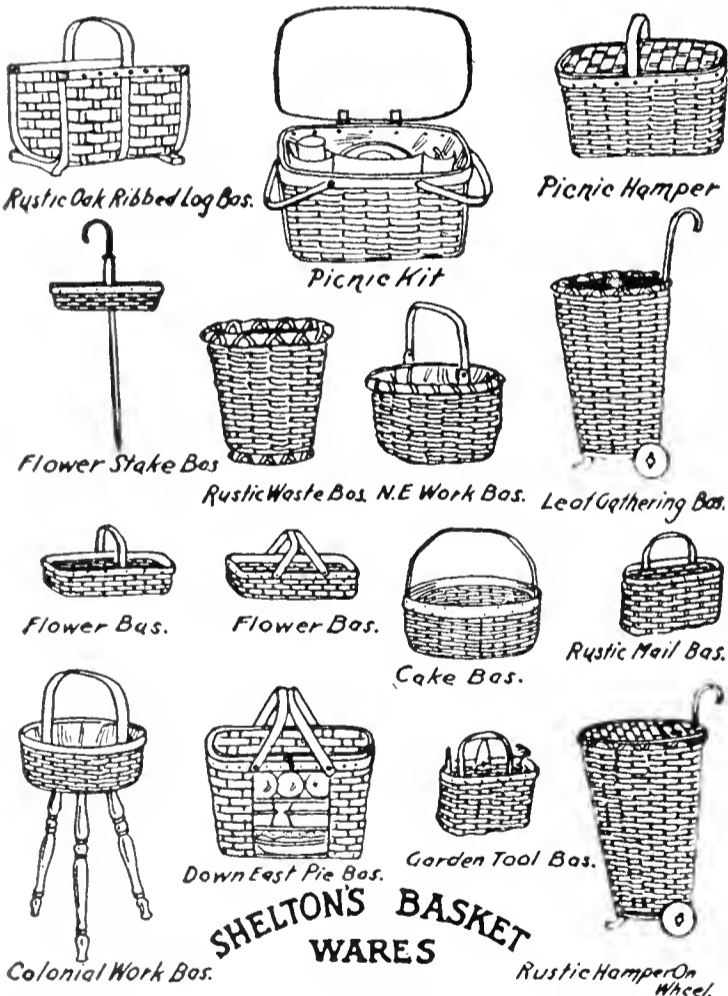

Rustic Oak Ribbed Log Basket. Made of hand drawn oak, and braced with oak ribs. Finished in walnut, with brass trimmings. Three sizes, \$3.00, \$3.50, \$4.00.

Rustic Waste Basket. Walnut finish. Two sizes, \$1.75, \$2.00.

Rustic Mail Basket. For replacing the commonplace mail box. Walnut finish. Also useful for garden tools. Price \$1.25.

Colonial Work Basket. An odd piece for the home or garden; very distinctive. Antique maple finish. Price \$4.50.

Flower Stake Basket. Made of hand drawn oak, finished in walnut and has a rustic cane with sharp ferrule to permit of easy insertion into the ground. Price \$4.50.

New England Work Basket. A quaint New England garden and work basket. Walnut finish. Three sizes, \$1.50, \$1.75, \$2.00.

Miniature Work Basket. Lined with old-fashioned chintz patterns. A distinctive gift. Delicately perfumed. Price \$1.50.

Leaf Gathering Basket. A handy basket for use about the lawn for gathering leaves, grass, etc.; made of hand-drawn oak. Price \$7.50.

Down East Pie Basket. Designed for packing pies, cakes or sandwiches for picnics, etc., and intended to prevent crushing. Made with three compartments as illustrated, and in a shallower model with but two compartments. Prices \$2.75 and \$3.50.

Flower Basket. For flowers and garden tools; and also a popular sandwich basket for bridge, beach and lawn parties. Walnut finish. Three sizes, \$1.25, \$1.50, \$1.75.

Cake Basket. A basket for carrying cake or sewing. Fitted with curiously shaped handle. Walnut finish. Price \$3.00.

Rustic Hamper on Wheels. Walnut finish. Price \$9.50.

Shelton Picnic Kit. A well-built basket, made of hand drawn ash, oak runners, and finished in walnut. Sold with complete service for four, consisting of green beetle ware tumblers and plates, stainless steel knives and forks, and silver-plated spoons. Price \$9.00.

Shelton Picnic Hamper. Picnic hamper, with the old-fashioned woven double cover. Finished in walnut, with brass trimmings. Price \$4.00.

Baskets, Tomato or Pansy. Wire handles, also used for fruit as well as plants.
 100 1000
 3-quart size\$4.00 \$35.00
 2-quart size 3.00 28.00

Baskets, Picking. For gathering fruit or vegetables. Swing or stationary bail. 1 pk. 75c, ½ bu. \$1.00, 3 pks. \$1.25.

Baskets, Shepherd. 1 bu. \$2.50 each; 2 bus. \$4.00 each.

Baskets. For holding leaves. 4 bus. \$4.00 each.

Baskets, Vegetable. ¼ bu. \$1.00 each; ½ bu. \$1.25 each; ¾ bu. \$1.50 each; 1 bu. \$1.75 each.

Baskets, Wire Hanging. Either round or flat bottom. 6 in. 30c each; 7 in. 40c each; 8 in. 50c each; 10 in. 60c each; 12 in. 70c each.

Bill Hooks. For heavy pruning. English. \$3.00.

Boxes for Cut Flowers. The following sizes are kept in stock.

No.	Length	Width	Depth	Doz.	100
1	18 in.	5 in.	3 in.	\$1.00	\$ 6.00
2	21 in.	5 in.	3½ in.	1.20	7.00
3	24 in.	5 in.	3½ in.	1.40	8.00
4	30 in.	5 in.	4 in.	1.60	9.00
5	21 in.	8 in.	5 in.	1.80	10.00
6	24 in.	8 in.	5 in.	2.00	11.00
7	28 in.	8 in.	5 in.	2.25	13.00
8	36 in.	8 in.	5 in.	2.50	16.00

Corrugated Shipping.

Size	Inches	Each	Doz.
B	24x12x6	\$.050	\$5.00
C	30x12x7	.60	6.00
D	36x12x9	.70	7.00
E	40x15x9	.80	8.50
F	48x15x9	1.00	10.00

Farm, Garden and Lawn Requisites, Tools, Etc.

Burlap. For putting around trees to trap gypsy moths. 8 in. wide, 8c per yard; 100 yards \$7.00. 40 in. wide, 18c per yard; piece about 100 yards, 16c per yard.

Burning Brands. For marking tools, etc. Six letters or less, \$5.00; each additional letter, \$1.00.

Bush Hooks. Strapped-eye handle. \$2.00.

Carnation Support, Excelsior. Heavy galvanized wire. In two sizes, 13 in., \$3.00 per 100; 20 in., \$3.50 per 100. One of each length makes a complete plant support.

Cotton Wadding. Large sheets, for protecting plants and flowers from frost. 12c each, \$1.25 per doz., \$8.00 per 100.

Cultivator, The Norcross Hand Garden. Does the work easier and faster than any wheel hoe.

5 prong, 4 ft. handle\$1.25

3 prong, 4 ft. handle 1.00

3 prong, 9 in. handle50

Celery Wrappers, Best quality parchment paper, printed. 12x15 in., pkt. 1000 sheets, \$3.50.

Dibbles. Steel points, wooden or iron handle. 75c each.

Edging Knife, American. \$1.25. Long or D Handle.

Edging Knife, English. \$2.50 each. Handles, extra, 50c.

Electric Tape. For mending hose, etc. 40c per coil.

Flower Pot Saucers, Thermold Rubber. Breakproof—leak-proof. Made of durable rubber compound with cleated bottom to allow water to drain from pot. Will not mar polished surfaces.

No. 1—For 4 in. pot\$0.15 \$1.50

No. 2—For 4½ or 5 in. pot20 2.00

No. 3—For 6 in. pot25 2.50

No. 4—For 6½ or 7 in. pot30 3.25

No. 4A—For 7½ or 8 in. pot35 3.75

No. 5—For 9 in. pot45 5.00

No. 6—For 10 in. pot65 7.00

No. 7—For 12 in. pot90 10.00

Hews Flower Pot, Standard. Measurement from inside to inside. Width and depth equal.

Inches	Doz.	100	Inches	Doz.	100
2	\$0.25	\$1.50	7	\$2.25	\$17.00
3	.35	2.50	8	3.25	24.00
4	.50	3.75	9	4.50	35.00
5	.90	6.75	10	6.50	50.00
6	1.40	10.00	12	12.00	90.00

Flower Pot Hanger, Krich's Perfect. No. 1 will fit from 3½ to 5 in. pots, 50c per doz. No. 2 will fit from 5 to 8 in. pots, 60c per doz. No. 3 will fit from 8- to 12-in. pots, 75c per doz.

Bulbs and Seed Pans, Round.

Size	Each	Doz.	Size	Each	Doz.
6 in.	\$0.15	\$1.50	9 in.	\$0.50	\$4.50
7 in.	.20	2.25	10 in.	.65	6.50
8 in.	.30	3.25	12 in.	1.25	12.00

Flower Pots, Neponset Green. Made of tough waterproof paper, eliminating breakage. Superior to any other pot on the market for the actual growing and transplanting of plants. Not less than one case at 1000 price.

Inches	In case	Doz.	100	1000
2¼	1000	\$0.15	\$0.75	\$ 6.50
2½	1000	.20	1.00	7.50
3	1000	.25	1.25	9.00
3½	1000	.30	1.50	12.00
4	500	.40	2.00	15.00
5	500	.50	2.50	20.00
6	500	.60	3.00	24.00

Flower Pots, Neponset Red. For storage, transplanting, and shipping. Specially treated and water-resistant. Not less than one case at 1000 price.

Inches	In case	Doz.	100	1000
2¼	1000	\$0.10	\$0.40	\$ 3.50
2½	1000	.15	.50	4.00
3	1000	.20	.60	4.50
3½	1000	.25	.75	5.75
4	500	.30	.90	7.00
5	500	.35	1.00	9.00
6	500	.40	1.25	12.00

Flower Vases, Galvanized Iron. Strong, light, durable, made of good material with heavy hoop at base of can to reinforce bottom of vase. These vases are finished in a moss green enamel baked on.

No.	Top Diam.	Bot. Diam.	Hght.	Each	Doz.
5	7¾ in.	5½ in.	11 in.	\$1.50	\$16.00
6	7¾ in.	5½ in.	17 in.	1.75	19.00
7	8 in.	6¼ in.	11 in.	1.50	16.00
8	9 in.	7¾ in.	12 in.	1.75	19.00
9	9 in.	7¾ in.	17 in.	2.00	22.00
10	6½ in.	5 in.	14 in.	1.50	16.00
11	5½ in.	4¼ in.	15 in.	1.50	16.00
12	5 in.	4 in.	9½ in.	1.35	15.00

Floral Tools, "American." These tools are not toys, but serviceable tools, of high grade material, well made and finished.

No. 4, P. S. F. 4-Piece Set: Shovel, Rake, Hoe, and Spading Fork\$3.00

No. 3 P. F. 3-Piece Set: Shovel, Rake and Hoe 2.00

Extra Rakes for above setEach .60

Extra Spading ForksEach 1.00

Extra HoesEach .90

Extra Floral ShovelsEach .90

Fork, Ensilage. 8 tine, D handle, strapped\$3.00

Forks, Hand. For transplanting, American50

Forks, Hand. For transplanting, English 1.25

Forks, Hay. 4 to 6 ft., bent handles\$1.50 to 2.25

Forks, Manure. 4 tine, mal. D handle, strapped 1.75

Forks, Manure. 5 tine, mal. D handle, strapped 2.00

Forks, Manure. 6 tine, mal. D handle, strapped 2.25

Forks, Manure. 4 tine, wood D handle, strapped 2.00

Forks, Manure. 5 tine, wood D handle, strapped 2.25

Forks, Manure. 6 tine, wood D handle, strapped 2.50

Forks, Manure. 4 tine, long handled, strapped 1.75

Forks, Manure. 5 tine, long handled, strapped 2.00

Forks, Manure. 6 tine, long handled, strapped 2.25

Forks, Spading. 4 tine, long handled, strapped 1.75

Forks, Spading. 4 tine, mal. D handle, strapped 1.75

Forks, Spading. 4 tine, wood D handle, strapped 2.00

Forks, Spading. 5 tine, mal. D handle, strapped 2.25

Forks, Stone. 8 tine, mal. D handle, strapped 2.75

Garden Lines, Braided. 100 ft. \$1.25, 200 ft. \$2.25.

Garden Line Reels. Small \$1.50, large \$2.00 each.

Glass Cutter. 25c and 50c each.

Glaziers' Points (Perfection). Will stop glass from slipping. Made of steel wire galvanized. Double point. Per box of 1000, No. 2, 75c; No. 2½, 85c.

Glaziers' Points (Zinc City). Made of zinc. Will not rust. In three sizes, ¾, ¾ and ¾ in. long. Each size, 65c per lb.

Gloves, Gardeners' Pruning. With gauntlets. \$2.00 per pair; without gauntlets, \$1.50 per pair.

Grafting Knife, or Chisel. All steel, \$1.25 each.

Grafting Wax. ¼ lb. 20c, ½ lb. 30c, 1 lb. 50c.

Grass Hooks, or Sickles. English, No. 2, \$1.00 each; No. 4, \$1.25 each; American, 50c and 75c each.

Grindstones, "Nova Scotia." Mounted on selected hardwood frames. Sizes vary from 20 in. to 30 in. in diameter. Prices from \$20.00 to \$30.00 each.

Wayward Vine Guide and Support

New—Practical.

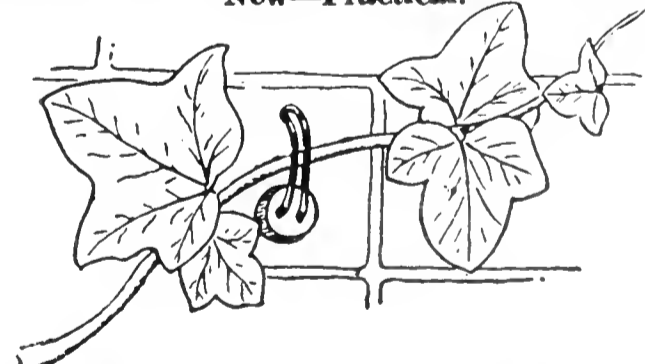

For training and supporting Ivy, Small Fruiting Trees, and all other Vines, etc., on brick walls or any other surface without defacing it.

Price: \$1.00 for box of 25, including cement. Special price on quantity lots. Red—White—Grey.

- Hammer, Nail.** Adze eye, bell face. \$1.00 to \$1.50 each.
- Hammer, Stone Striking.** Solid cast steel. 25c per lb.
- Hatchet, Barrel.** \$1.00 to \$1.50 each.
- Hatchet, Axe Pattern.** \$1.25 and \$1.50 each.
- Handles, Axe.** Extra quality hickory. 75c each.
- Handles, Hammer.** Extra quality hickory. 50c each.
- Handles, Pick.** Extra quality hickory. 75c each.
- Handles, Hay Fork.** Extra quality ash. 50c to \$1.00 each.
- Handles, Hoe.** Extra quality ash. 35c each.
- Handles, Manure Fork.** 75c to \$1.25 each.
- Handles, Shovel and Spade.** 75c each.
- Handles, Rake.** 50c each.
- Hoes, Nurserymen's Two-pronged Steel.** \$2.50 each.

Farm, Garden and Lawn Requisites, Tools, Etc.

- Hoes, Boothby-toothed. \$1.50 each.
- Hoes, Humphrey. \$1.25 each.
- Hoes, American Scuffle, Handled. 8 in. \$1.25.
- Hoes, English or Dutch Scuffle. 3 in., \$1.00; 4 in., \$1.10; 5 in., \$1.25; 6 in., \$1.35; 7 in., \$1.50; 8 in., \$1.65; 9 in., \$1.75 each. Handled, extra 50c.
- Hoes, Grading. 7 in. blade, 4 ft. handle. \$2.50 each.
- Hoes, Market Gardeners' Slide or Scuffle (Arlington). Handled, 4 in. to 9 in. \$3.00 each.
- Hoes, Garden, Socket Draw. 8 in. \$1.25 each.
- Hoes, Meadow. 9 in. \$1.35; 10 in. \$1.50 each.
- Hoes, Warren. \$1.50 each.
- Hoes, Mortar or Street. 10 in., \$1.50 each.
- Hoes, Ladies' and Boys'. 75c and \$1.00 each.
- Hoes, Onion. \$1.25 each. Square or round top.
- Hoes, Weeding. 6 tooth. \$1.00 each.

Hose, Rubber Garden, "Dreadnaught Brand." A braided hose made of the best materials. Does not kink. We offer this in 25 and 50 ft. lengths coupled; also in continuous lengths of 500 feet. 1/2 in. at 20c per ft.; 3/4 in. at 22c per ft.

- Hose Reels.** All metal, strong, substantial hose reels for gardens or lawns. Made with high wheels, almost indestructible.
 - No. 10, holding 100 ft. \$4.50 each.
 - No. 20, holding 150 ft. \$5.00 each.
- Hose Connection, Shut-off.** For use with any nozzle that has no shut-off where one is desired. \$1.00 each.
- Hose Connection, Siamese.** \$1.00 each.
- Hose Couplings.** 1/2, 3/8 and 1/4 in., per set, 25c each.
- Hose Mender (Hudson's Pattern).** Wizard sheet brass tubes. Substantial yet light in weight. Does not obstruct water way of hose. 1/2, 3/8 and 1/4 in. 5c each, 50c per doz. Wires, 25c per doz., \$1.75 per 100.
- Hose Mender, Cooper's.** Made of heavy brass, requires no wires or pliers to adjust it. 10c each, \$1.00 per doz.
- Hose Menders, Perfect Clinching.** In one piece, doing the work of the mender tube and two clamps ordinarily used. 1/2, 3/8 and 1/4 in., 10c each, \$1.00 per doz.
- Hose Clamps.** Made of galvanized steel with screw adjustment. 1/2 and 3/4 in., 5c each, 50c per doz.
- Hose Reducers.** For connecting 1/2 in. and 3/4 in. hose couplings with Bordeaux or Vermorel nozzles. 35c each.
- Hose Nozzle, Bordeaux Spray.** \$1.25 each.
- Hose Nozzle, New Boston.** Will throw a coarse or fine spray or a large or small stream. 75c each.
- Hose Nozzle, Stott's.** Specially recommended for greenhouse spraying. Throws a forcible side spray. Single spray, \$2.00 each; double spray, \$3.00 each.
- Hose Nozzle, Rose Spray.** For greenhouse, flower garden, hotbed, etc. Heavy brass, 3 in. face, \$1.00 each; 4 in. face, \$1.25 each. Light brass, 3 in. 75c each; 4 in. \$1.00 each. "Greenhouse," with coarse and fine 4 in. spray, \$2.50 each.
- Hose Nozzle, The Paradise Hydro-Spray.** The syringing nozzle with the washing spray is positive in its action; is of solid brass construction for control of red spider and mealy bug on chrysanthemums, pompons, sweet peas, carnations, geraniums, roses, etc.
 - 10-inch size with two different sizes oriphic tips, \$3.00.
 - 18-inch size with two different sizes oriphic tips, \$3.50.
 - Oriphic tips extra. 50c.
- Hose Nozzle Holder "Aqua-matic."** Any hose nozzle can be attached; entirely of brass. By a pressure of the fingers on the handle, the spray is turned on, by releasing the pressure the spray automatically shuts off. \$1.25 each.
- Hose Washers, Rubber.** For 1/2 in. and 3/4 in. hose. Doz. 10c, 1/4 lb. 35c, lb. \$1.00.
- Knives, Budding and Pruning.** Imported. In various styles, \$1.50 to \$5.00 each.
- Labels, Copper.** Made of copper and copper wired. Indestructible and always legible. No. 1, 3 1/2 x 1/4 in., \$2.00 per 100; No. 2, 5 x 1 1/2 in., \$2.50 per 100.

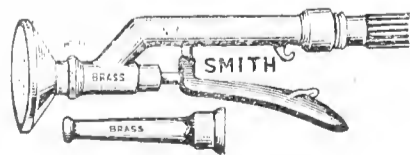

Labels, Wood. For plants and trees.

	Plain or Painted	Plain	Painted
	100	1000	1000
4 in. Pot Label	\$0.30	\$1.80	\$ 2.20
5 in. Pot Label	.35	2.00	2.40
6 in. Pot Label	.40	2.25	2.75
8 in. Garden Label	.85	6.00	7.75
10 in. Garden Label	1.00	7.50	9.00
12 in. Garden Label	1.35	10.50	12.00
3 1/2 in. Tree Label	.25	1.50	2.00
3 1/2 in. Tree, iron wired	.30	2.00	2.50
3 1/2 in. Tree, copper wired	.35	2.25	2.70

Labels, The Perfect Garden Label. Marked with ordinary lead pencil this label is permanent in all garden conditions above or under the soil. This feature has been thoroughly tested. The material is indestructible. The beautiful cool gray-green color blends perfectly with foliage, soil and rocks. They should be set deep in the soil with only the marking space showing. Thus they are inconspicuous and do not interfere with weeding and cultivating. Any part of the label may be used as marking space for extensive notes. Markings are erasible with pencil eraser. Tie-on labels are supplied with wires in convenient bundles ready bent for attaching.

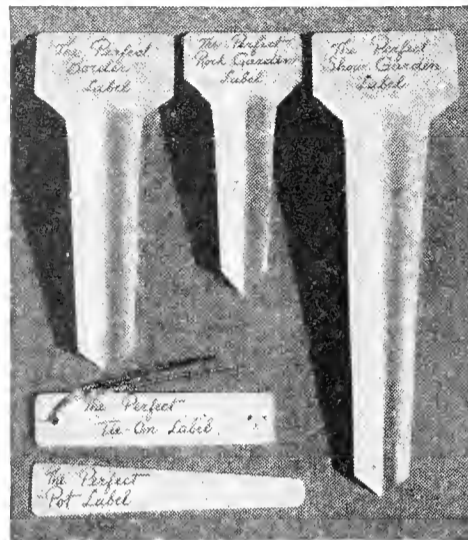

- Border size, 5 in. labels. 12, \$1.00; 25, \$2.00; 100, \$7.75.
- Rock Garden size, 4 in. labels. 12, 90c; 25, \$1.75; 100, \$6.75.
- Show Garden size, 7 in. labels. 12, \$1.25; 25, \$2.50; 100, \$9.50.
- Tie-on label 3/4 x 3 1/2 in., with wires. 50, \$1.75; 100, \$3.00.
- Pot label, 3/4 x 4 in., tapered. 50, \$1.50; 100, \$2.50.

Lawn Rake, "MULTIPLEX" Flexible Spring Steel. The MULTIPLEX Lawn Rake is a tool of exceptional merit; it meets the demand of the public for a rake that may be firmly adjusted to various widths (9 in. to 22 in.), as the occasion demands. It is sufficiently large for general use, and small enough for use among closely growing shrubbery. This is truly the most practical and useful Lawn Rake on the market today. Price, \$1.25 each.

Mats, Hotbed. Made by hand of the best rye straw. Size 6x6, \$3.25; 6x3, \$2.00.

Mats, Hotbed. 76x76 in. Covers two sash, made of heavy cotton or duck, filled and quilted. \$5.00 each.

Mattocks, Short cutter or grub hoe. 3 lbs. \$1.00 each.

Mattocks, Long Cutter. Extra quality. \$1.50 each.

Mattocks, Pick. Extra quality. \$1.25 each.

Melon Nets. For supporting Melons in the greenhouse. 25c each, \$2.50 per doz.

Mole Traps, "Little Giant." \$1.00 each.

Oilers. With spring bottom. 25c to 75c each.

Oil, Harvester. For mowers, reapers, etc. Gal. \$1.25.

Pails, Stable. Heavy galvanized iron. 10 qt. 40c, 12 qt. 50c, 14 qt. 50c.

Paper, Green Waxed. Sheets 12x18 in., lb. 50c; ream, about 3 lbs., \$1.25. Sheets, 24x36 in., lb., 50c; ream, \$4.00.

Paper, White Tissue. Sheets 20x30 in., lb. 40c; ream, about 7 lbs., \$2.00. Sheets 24x36 in., lb., 40c; ream, \$3.00.

Paper, White Waxed. Sheets 12x18 in., lb. 50c; ream, about 5 lbs., \$2.00. Sheets 24x36 in., lb., 50c; ream, \$4.00.

Paper, White Wrapping. Sheets 24x36 in., lb. 20c; ream, about 40 lbs. 18c per lb.

Pencils, Indelible Label. With point protector. Black or blue, 20c each. (Wolff's English Garden.)

Picks, Contractor. Best quality, \$1.50 each.

Plant Tubs, Richmond Style. Strongly made of selected white cedar and bound with electric welded wire; painted green. Without handles.

No.	Diam. inside	Each	No.	Diam. inside	Each
6	11 in.	\$1.25	11	16 in.	\$2.50
7	12 in.	1.50	12	17 in.	2.75
8	13 in.	1.75	13	18 in.	3.25
9	14 in.	2.00	14	19 in.	4.00
10	15 in.	2.25			

Farm, Garden and Lawn Requisites, Tools, Etc.

Plant Tubs, Cedar. For ferns, palms and other large plants. Made of thick cedar, nicely painted green. Drop handles. No. 2 and larger have hook handles. Outside measurements:

No.	Diam. across top	Height outside	Each
1	28 in.	22 in.	\$17.00
2	26 in.	20 in.	14.00
3	24 in.	18½ in.	9.00
4	22 in.	17 in.	7.25
5	20 in.	16 in.	6.25
6	18 in.	15 in.	5.00
7	17 in.	14 in.	4.25
8	16 in.	13 in.	3.75
9	14 in.	12 in.	3.00
10	12 in.	9½ in.	2.50

Plant Sprinklers, Rubber. 50c to \$1.50 each.

Post Hole Digger. 4 ft. Atlas, \$2.00 each.

Poles, Wooden. 12 ft. long. Used for pruning and tree painting. 65c each; \$7.00 per doz.

Potato Hooks. Steel shank, 5 tine, \$1.50; 6 tine, \$1.75.

Potato Digging Fork. 6 tine, \$2.00.

Pruner, Standard Tree. Operated by a lever, to which the blade is connected by iron rod, 6-ft. pole, \$2.00; 8 ft. pole, \$2.25; 10-ft. pole, \$2.50; 12-ft. pole, \$2.75; 14-ft. pole, \$3.00; 16-ft. pole, \$3.50 each. Extra blades, 25c each.

Pruner, Telephone Tree. Without pole. A pole of any length to suit requirements can be inserted in the socket. It is operated by a cord tied in the end of the lever. \$1.75 each. Extra blades, 25c each. Extra springs, 25c each.

Pump, Kinney's Atomizer. For use in greenhouses to distribute liquid fertilizer or to mix or temper hot and cold water under pressure. \$3.00 each.

Putty Bulb. For glazing greenhouse sash. \$1.50 each.

Putty, Twemlow's Old English Glazing. A superior article for bedding glass in sash or filling cracks or seams in roof joints, etc. 1 gal., \$2.75; 5 gals., \$12.50.

Raffia. The best material for tying. Soft, pliable and strong. 40c per lb.

Raffia, Green. For tying plants, etc., \$1.25 per lb. pkg.

Rakes, Bamboo. Reinforced. Fan shape, 18 in., 65c; 24 in., \$1.00; 30 in., \$1.25, each.

Rakes, Brume. Steel, fan-shaped rake; used as a broom; strong and durable. \$1.25 each.

Rakes, Hay, Wood. Extra quality, three bow. \$1.00 each.

Rakes, Lawn, Wood. Extra quality. Three bow. \$1.25 each.

Rakes, "Lawncomb." New socket pattern. 24 tooth. \$1.25 each.

Rakes, Gumfinger Lawn Rubber. The teeth are live, resilient rubber, stiff enough to rake clean, but flexible enough not to tear or uproot the grass. Rakes clean over rough surface. The rubber teeth adjust themselves to every irregularity in the ground. Light and easily handled. No risk of injury if rake is left with prongs turned upright. Made in four sizes: 8 in., 75c; 16 in., \$1.00; 20 in., \$1.25; 24 in., \$1.50.

Rakes, Steel Garden. Long teeth. 10 teeth, \$1.00; 12 teeth, \$1.15; 14 teeth, \$1.25; 16 teeth, \$1.35; 18 teeth, \$1.50.

Rakes, Steel Lawn. Short teeth. 12 teeth, \$1.25; 14 teeth, \$1.40; 16 teeth, \$1.50; 18 teeth, \$1.65.

Rope, Columbian Tape-marked. Pure manila. "The guaranteed rope." In various sizes. Market price.

Sash, Hotbed. Well made from thoroughly seasoned lumber and glazed with double thick glass. Frame 1¼ in. 3x6 ft., \$7.50 each. Crating extra at cost.

Saws, Cross Cut, Two Man. Filed and set. ready for use. 5 ft., \$5.00 each. Handles, 50c per pair.

Saws, Cross Cut, One Man. With supplementary handles. 3 ft., \$3.50; 3½ ft., \$4.00 each.

Saws, Pole Pruning. \$2.00 to \$3.50.

Saws, Pruning. Single and double edge. Extra refined spring steel. 18 in., \$1.75; 20 in., \$2.00 each.

Saws, Wood (Buck). Complete, \$2.00 each.

Scissors, Flower. For cutting and holding flowers. 7 in. \$2.00 each.

Scissors, Grape or Vine. For thinning the bunch. Nickel-plated. 7 in., \$2.00 each.

Scoops, Coal. Extra quality. No. 2, \$2.00; No. 3, \$2.25; No. 4, \$2.50; No. 5, \$2.75; No. 6, \$3.00 each.

Scythes, "Witherell's" Finest Cutlery Steel. Fully warranted. \$2.25 each.

Scythes, Broad English or Lawn. \$3.50 each.

Scythes, Heavy Bush. \$2.50 each.

Scythes, Weed or Bramble. \$2.50 each.

Scythes Snaths. \$2.00 each; bush, \$2.25.

Scythe Stones, Carborundum. 50c each.

Scythe Stones, English Round. Talacre, 40c each.

Scythe Stones, "Manchester." 20c each.

Seed Sower, "Cahoon." Best machine for sowing broadcast, grass seed, oats, barley, etc. \$5.00 each.

Silkline (Smilax Thread). Spools 40c each, box of 8 spools, \$3.00.

Shears, Wiss Grass. Number 5600, \$1.00.

Shears, Wiss-Clipper Grass. Number 700, \$1.25.

Shears, Wiss-Hedge. New shock-absorbing, steel handle. 8 in., \$2.50 each; 9 in., \$3.00 each; 10 in., \$3.50 each.

Shears, Wiss Pruning. Various styles. From 75c each to \$4.00 each.



Branch or Lopping Shears

The Forester. (Three power.) Latest, and considered the cleanest, easiest and fastest cutting shear manufactured.

- | | Price |
|---|--------|
| No. 1. Cuts 1-inch diameter. Length 20 inches | \$5.00 |
| No. 2. Cuts 1½-inch diameter. Length 27 inches | 6.00 |
| No. 3. Cuts 2-inch diameter. Length 34 inches | 7.00 |
| Shears, Grass Border. Long handle, 8 in. blade, 9 in. blade, \$6.50; 10 in. \$7.00 each. Long handle wheel, 9 in. blade, \$7.00 each. | |
| Shears, Grass or Sheep. \$1.00. English extra quality, \$2.50. | |
| Shears, Hedge or Grass. English pruning notch. 8 in. blade, \$4.00; 9 in., \$4.25; 10 in., \$4.50 each. | |
| Shears, Lawn or Grass. Long handle, 9 in., \$6.50 each. | |
| Shears, Dahlia or Root. Imported. \$5.00 each. | |
| Shears, Ladies' Hedge. American, 6 in. \$2.00. English, \$3.00. | |
| Shears, Ladies, Pruning. 6 in. rose, \$2.00 each. | |
| Shears, German Pruning. Nickel-plated, lock nut, volute spring. 8 in., \$3.00; 9 in., \$3.50; 10 in., \$4.00 each. | |
| Shears, Pruning, French. With wheel spring, polished, 8 in., \$2.50; 9 in., \$3.00; 10 in., \$3.50. Extra springs, 50c. | |

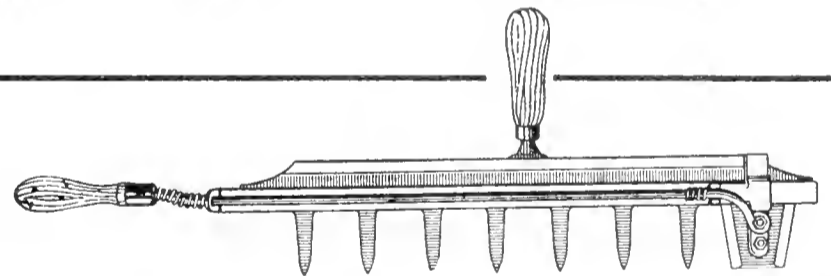

Shears, "Cyclone" Hedge Trimmer. Faster cutting, more uniform trimming, easy to operate. Eliminates slow, tiresome trimming of hedges and assures even and uniform results. Frequent trimming is made possible due to the speed and ease of operation, resulting in beautifying and strengthening the hedge. The Cyclone weighs only 3 lbs. and is designed to be self-balanced, allowing for straight, level trimming. \$6.00 each.

Shovels, Genuine English "Sheffield." Polished. Long or short handle, round point. \$2.50 each.

Shovels, Superior Steel. Round or square pointed D or long handle. No. 2, \$2.25 each; No. 3, \$2.50 each.

Shovels, Market Gardeners'. Light weight for banking Celery, etc. Long handle. \$1.75 each.

Sod Lifter. Useful for cutting under sod as it is being rolled. English, \$8.00; American, \$3.50.

Spades, Superior Steel. Extra quality. Either D or long handle. No. 2, \$2.25 each. English, \$2.50 each.

Stake Fasteners. Galvanized, rustproof wire. Hold the stakes and cross wires firmly.

Eureka. Small and light. Pkg. of 1000, \$3.00.

Everlasting. Heavy and strong. Pkg. of 1000, \$4.50.

Wire Plant Ties. Pkg. of 1000, \$2.50.

Stakes, Japanese Bamboo Garden. Very strong and durable. ½ to ¾ in. in diameter. 4 ft., 50c per doz., \$4.00 per 100. 6 ft., 75c per doz., \$5.50 per 100. 8 ft., \$1.00 per doz., \$7.00 per 100.

Farm, Garden and Lawn Requisites, Tools, Etc.

Stakes, Japanese Cane, Green. Small and inconspicuous, but strong and useful for plants.

	Doz.	100	1000		Doz.	100	1000
1½ ft.	\$0.12	\$0.50	\$2.50	3½ ft.	\$.25	\$1.00	\$ 6.50
2 ft.15	.65	3.25	4 ft.30	1.25	8.00
2½ ft.18	.75	4.50	5 ft.35	1.50	10.00
3 ft.20	.90	5.50	6 ft.40	2.00	15.00
6 ft., plain, 40c per doz.,	\$1.75 per 100, \$14.00 per 1000						
8 ft. plain, 50c per doz.,	\$2.50 per 100, \$22.00 per 1000.						

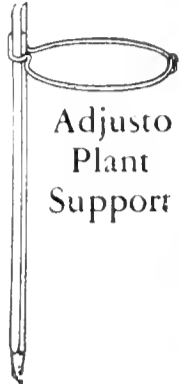

Adjusto Plant Support

ADJUSTO PLANT SUPPORTS

Unexcelled for Tomatoes, Dahlias, Delphiniums, Hollyhocks, Etc.

Consists of a sturdy 7/8 in. square stake, pointed at one end, stained green and equipped with a strong, green enameled spring wire loop, adjustable to any height with growth of plants. Adjusto Supports are usable for years. Prices: 3 ft. height, \$2.50 per doz.; 4 ft. height, \$2.75 per doz.; 5 ft. height, \$3.00 per doz.; 6 ft. height, \$3.25 per doz.

Stakes, Garden, Painted Green. For house, greenhouse, and conservatory.

Light Round Stakes

Ft.	Doz.	100	Ft.	Doz.	100
1½	\$0.30	\$2.25	3½	\$1.25	\$ 8.50
2	.50	3.50	4	1.50	11.00
2½	.70	5.00	5	2.25	16.00
3	1.00	7.00			

Heavy Round Stakes

Ft.	Doz.	100	Ft.	Doz.	100
3	\$1.75	\$12.00	5	\$2.50	\$18.00
4	2.25	16.00	6	3.00	22.00

Square Stakes

Ft.	Doz.	100	Ft.	Doz.	100
1½	\$0.25	\$1.50	5	\$2.00	\$14.00
2	.35	2.50	6	2.25	16.00
2½	.50	3.50	4 Ex. heavy	2.00	14.00
3	.80	6.00	5 Ex. heavy	2.50	18.00
3½	1.10	8.00	6 Ex. heavy	3.00	22.00
4	1.35	10.00			

Stakes, Square, Unpainted. Hardwood 100 1000
 28 inches long \$0.75 \$6.00
 36 inches long 1.00 8.00
 48 inches long 1.25 10.00

Sticks, Match. Pine, 5-32 inch thck. Green, 50c per 100, \$4.00 per 1000.

Styptic, Thompson's (Imported). To prevent the bleeding of grape vines. Small bottle \$1.50, large \$2.00.

Tamper. Dirt and sod, high grade. 8x8 base. \$2.00 each.

The New Weed Puller. Out-U-Kum. Guaranteed to remove the root with the weed. A slight push and a pull does the trick. Price 75c each.

Thermometers, Wilder's. Japanned tin case, convex scale. 6 in., 75c; 8 in., \$1.00; 10 in., \$1.25.

Thermometers, Wilder's. Japanned tin case, heavy, 8 in., \$1.40; 10 in., \$1.50; 12 in., \$1.75.

Thermometers, Standard, Hotbed. Boxwood, \$3.00.

Tinfoil. For bouquets, etc. 30c per lb; green, 50c per lb.

Tree Scrapers. \$1.25 each.

Trellises. Not carried in stock, but can be shipped promptly from factory. If crating is required in shipment, it will be charged at cost. Sizes 1½ ft. to 12 ft. Prices on application.

Trellis, Tomato. Two hoop; 20c each, \$2.25 per doz.

Trellis, Tomato, Handy Vine. Made of wood and wire. 35c each, \$3.50 per doz.

Trowels, Garden, English Genuine. 6 in., \$1.00; 7 in., \$1.25.

Trowels, Garden, English Solid Stainless Steel. \$2.00 each.

Trowels, Transplanting. 6 in. 20c; 7 in. 25c each.

Trowels, Pointing. 4½ in. 50c each.

Trowels, Flat, Steel. Best steel, 7 in. \$2.00 each.

Trowel, Garden. Extra forged steel. Solid steel blade and shank. 6 in. 75c; 7 in. 85c, each.

Truck and Leaf Rack, with 3½-in. tires, \$35.00.

Truck and Hand Cart Box, with 3½-in. tires, \$28.00.

Extra Barrels with Trunnions, \$6.50; extra trunnions, \$1.00 a pair.

Leaf Rack only, \$14.00; **Hand Cart Box only,** \$6.00.

Twine, Green Linen. For Smilax, 40c per ball.

Twine, Green Cotton. 20c per ball, \$2.00 per doz.

Twine, Hard. "For tying parcels," Heavy, medium and light. 50c per ball, \$5.50 per doz.

Twine, Soft. 2-, 3-, or 5-ply jute. 25c per ball.

Twine, Tarred Marline. Twisted. In 5-lb. and 10-lb. balls. Each 85c per lb.

Twine, Tarred Yarn (Lathyrn). Excellent for tying shrubs etc., 35c per lb.

Twine, White Cotton. 20c per ball, \$2.00 per doz.

Twine, Yacht Marline. In ½-lb. balls, 50c each.

Watering Pots. Galvanized iron detachable rose watering pot. 4-qt., 85c; 6-qt., \$1.00; 8-qt., \$1.15; 10-qt., \$1.25; 12-qt., \$1.50.



Watering Pots, English Pattern.

An ideal pot for watering seedlings, cuttings, etc. 3 qt. \$7.00, 4 qt. \$8.00, 6 qt. \$9.00, 8 qt. \$10.00, 10 qt. \$11.00 each.

Watering Pots, Galvanized Iron. The best watering pot made, for strength, durability and neatness. Made from best quality iron; the top and back handles riveted on; an iron band on the bottom; the spout riveted, and a brace around it riveted to the body, and galvanized after it is made. A coarse and fine copper-faced rose with each pot. Extra rose 75c. Each

4 qts., spout 18 in. long	\$5.50
6 qts., spout 21 in. long	6.00
8 qts., spout 23 in. long	6.50
10 qts., spout 25 in. long	7.00
12 qts., spout 25 in. long	8.00

Watering Pots, French Pattern. Made of galvanized iron; oval in shape, with brass handle and long spout; one fine and one coarse copper-faced rose with each. 6 qt. \$7.00, 8 qt. \$7.50, 10 qt., \$8.00, 12 qt. \$8.50 each.

Wedges. Truckee pattern, solid cast steel. 15c per lb.

Weeder, Magic. Hand, 3-tine, 18 in. handle, 25c each; 30-in. handle, 40c each; 4-tine, heavy 42-in. handle, \$1.00 each.

Weeder, Onion. Triangle-shaped, 8 in. handle, 3 in. blade, 40c each; 4 ft. handle, 3 in. blade, 75c.

Weeder, Three-pronged. 60c each. Long handle, \$1.00.

Weeder, Excelsior. 20c each.

Weeder, Hazeltine. Steel blade, with wooden handle. 35c each.

Wires, Annealed galvanized. No. 14, \$1.50; No. 16, \$1.75; No. 18, \$2.00; No. 20, \$2.25 per stone of 12 lbs., in coils.

Wrenches, Monkey. Knife handle. 6 in., \$1.00 each; 8 in., \$1.25 each; 10 in., \$1.50 each; 12 in., \$2.00 each; 15 in., \$2.50 each.

Wrenches, Stillson. Length when opened, 6 in., 75c each; 8 in., \$1.00 each; 10 in., \$1.25 each; 14 in. \$1.50 each; 18 in., \$2.00 each; 24 in., \$3.00 each.

ANTIPESTICK INSECT CONTROL



Direct from Garden Hose

Antipestick - Foodndrink - Sulphur - Pyrethrum

Antipestick Cartridge for control of plant pests, thrips, aphids, green flies, plant lice, etc. 35c each; \$4.00 doz.

Foodndrink Cartridge. A balanced plant food for lawns and plants. 5c each; 25 for \$1.00.

Sulphur Cartridge for control of mildew, rust, black spot, fungous diseases, red spiders and ants. 35c each; \$4.00 per doz.

Pyrethrum-Rotenone Cartridge for control of most chewing and sucking insects. 35c each; \$4.00 per doz.

Brass Container Nozzle. \$1.00. Extension spray elbow (for spraying under the leaves), 75c. Shutoff, \$1.25.

Grey's Approved Sprayers for Insecticides and Fungicides

Smith Wheelbarrow Sprayer

With or Without High Pressure Tank

For use in spraying orchards, garden truck, etc.; also for spraying whitewash, cold water paints, disinfectants and for general spraying purposes. Exceptionally well built for long, hard service. All working parts are brass. The high pressure air tank, guaranteed for 50 lbs. pressure, will spray for a considerable length of time after the pressure has been pumped up. The extra large wheel permits easy wheeling. The pump is very powerful.

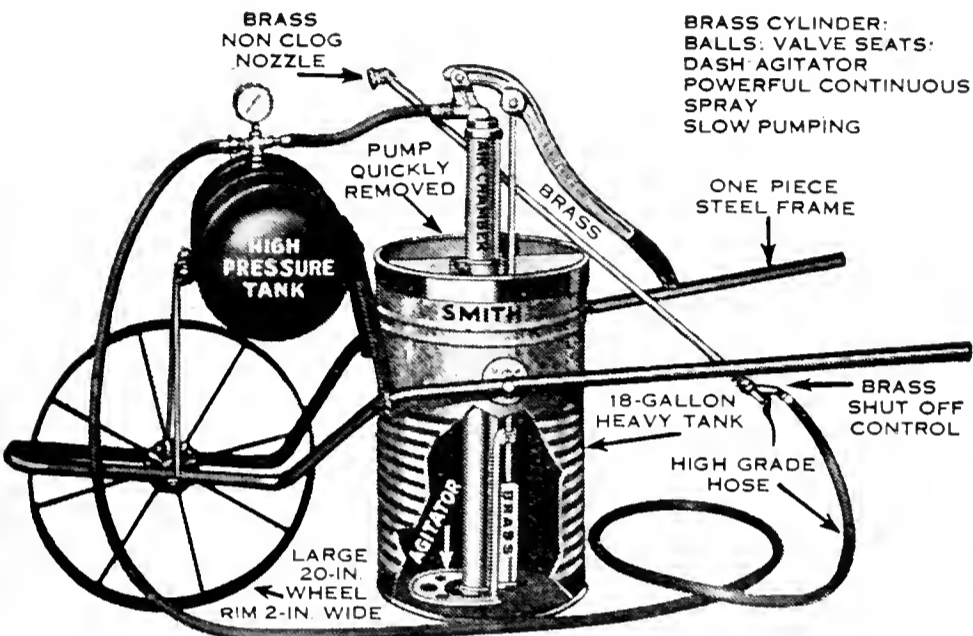

No. 60PG—Complete, with High Pressure Tank and 18-gallon Galvanized Bucket. Price, \$35.00.

No. 60G—Complete, with 18-gallon Galvanized Bucket, but without High Pressure Tank. Price, \$25.00.

Equipped with pneumatic rubber tire wheel, \$5.00 extra.

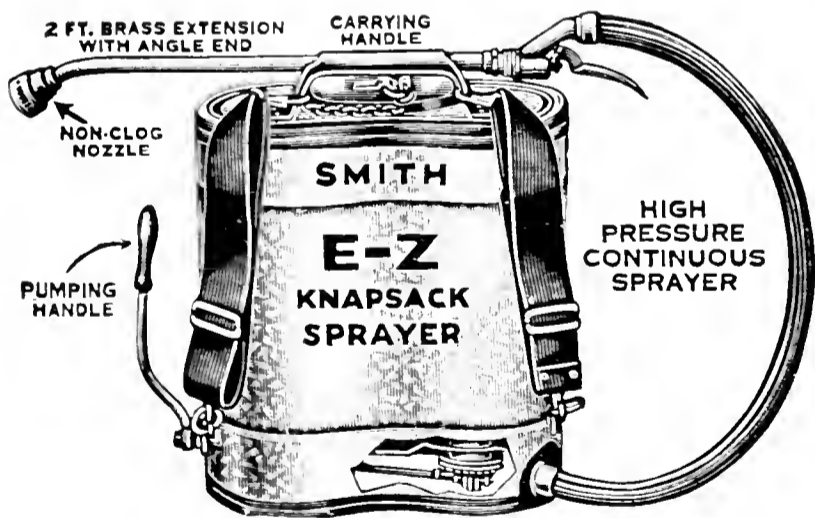

The latest for spraying all truck and field crops, fruit trees, shrubs, flowers, etc. Easily operated when in position on carrier's back. Has large diaphragm pump for high pressure and continuous even spray.

Specifications

Tank. 4-gallon capacity, kidney-shaped to fit back. Copper bearing galvanized steel or solid copper. Large brass filler opening with removable brass strainer.

Air Chamber and Valves. Large capacity for continuous high pressure. Valves specially compounded rubber seating on machine brass valve seat and easily removed if desired.

Hose Section. 3 feet best grade hose equipped with cast automatic shutoff. 2 foot seamless brass, angle end extension pipe which is removable if desired.

Nozzle. Heavy brass. Non-clog.

No. E-Z-B-Knapsack Sprayer, complete with solid copper tank, \$18.50.

No. E-Z-G-Knapsack Sprayer, complete with galvanized steel tank, \$12.50.

"New - Open - Top Banner Compressed Air Sprayer."

For use in spraying all insecticides on gardens, vegetables, shrubbery, flower beds, etc. Is made with either solid copper tank or with galvanized steel tank. Each sprayer comes complete with hose, nozzle, and brass extension rod. No. 22C0 4 gallon copper tank, \$9.50; No. 22G0 4-gallon galvanized tank, \$6.50; No. 25B0 2½ gallon solid brass tank, \$8.00; No. 25G0 2½ gallon galvanized tank, \$5.00.



Brown's Open-Hed Compressed Air Sprayer.

Comprising all the latest features in a sprayer of its kind. The first sprayer made with electrically welded seams and galvanized after fabrication. It has a double-acting pump lock with rubber grip pump handle; is quickly, easily locked or unlocked. Both hands can be used for pump. Excellent machine for use with all spraying solutions, for spraying in the garden around the house, dairy barn, poultry house, etc. No. 4B 4-gallon brass-copper alloy tank, price complete \$10.00; No. 4D 4-gallon heavy steel galvanized tank, price complete \$6.50; No. 3B 3-gallon brass-copper alloy tank, \$9.00; No. 3D 3-gallon heavy steel galvanized tank, \$5.75.

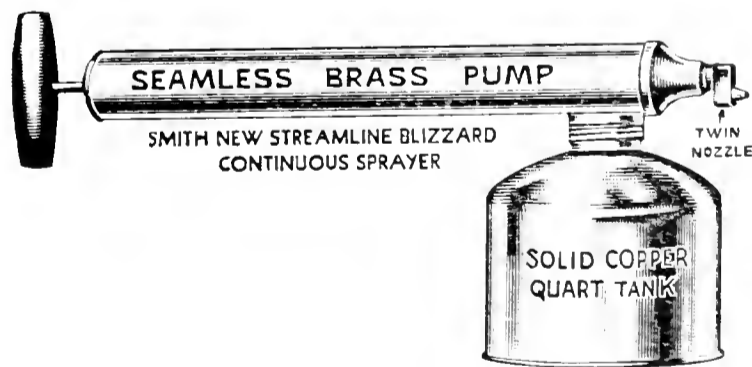

"The New Streamline Blizzard Continuous Hand Sprayer."

For spraying all insecticides on flowers and vegetable plants, shrubbery, etc.; disinfectants, cattle spray, or anything in liquid form. Price \$1.85. Additional Long Brass Extension Nozzle for spring straight ahead or under side of leaves of low growing plants, 50c extra.

Various sizes of small Hand Sprayers from 1 pint size to 3 qts. 50 cents to \$3.50 each.

Sturdy Spray Pump

Made Entirely of Brass.

Double Action—Continuous Unbroken Spray

Sprays All Insecticides, Disinfectants and Whitewash

Used with pail, bucket, or barrel by simply placing bucket strainer in such vessel. It works with ease on the up-and-down stroke. One brass tube works inside the other. It will spray the tallest tree from the ground.

Tank—5 gal. galvanized steel, as ordered. Complete with carrying straps.

Price, complete, \$10.00. Pump only, \$5.00.

Grey's Approved Dusters

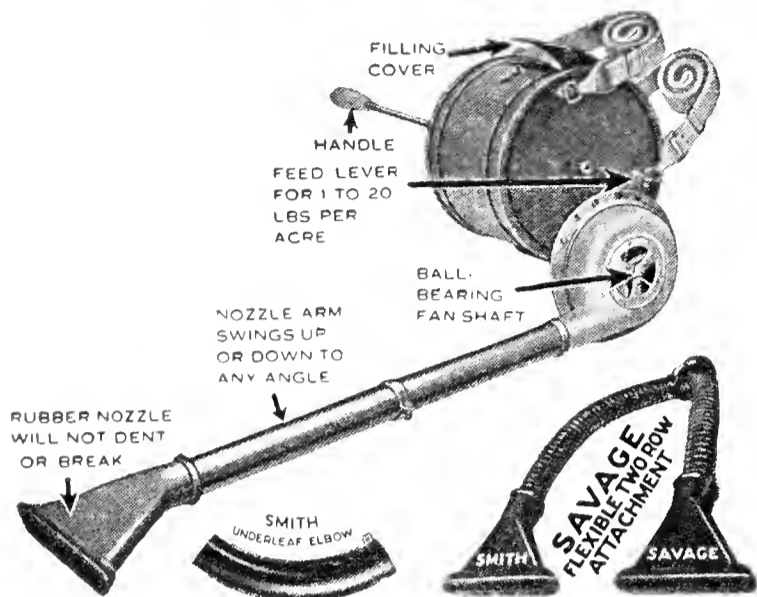

'Savage Duster.' Handles everything in powdered form; a high grade, well-built duster made to stand long, hard service. Highly adapted for spraying garden, vegetables, shrubbery, plants, etc. It is free running and easy cranking. has no brushes or wipers. Bronze and steel gears packed in grease, sealed-in gear case; never requires any attention, fan shaft runs on ball bearings. Under-leaf elbow for dusting under side of vines, connects between pipe and nozzle, is furnished without extra cost. Price complete, \$22.00. Two-row attachment, connects to dust pipe for dusting two rows with one passing, furnished complete with two rubber nozzles. Price \$3.50.

NO. 17 DUST KING POWDER DUSTER
A Powerful, Smooth Operating, Low-Priced One-Man Duster

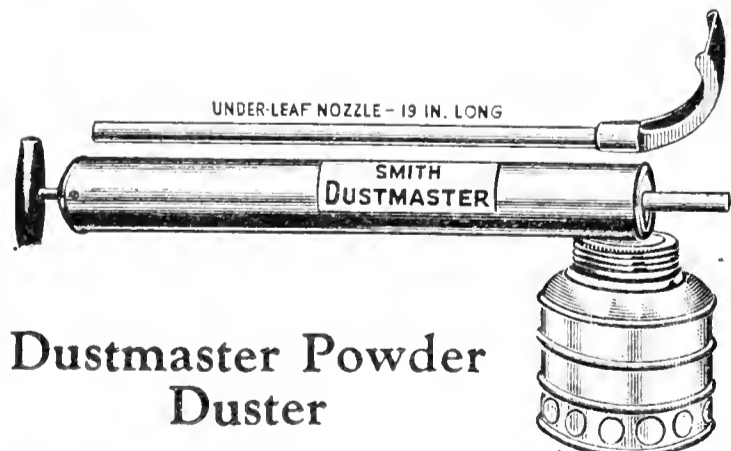
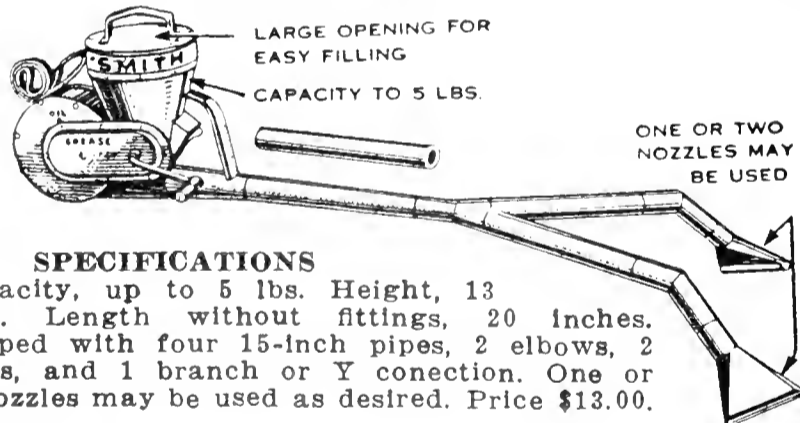

Dustmaster Powder Duster

A Splendid High-Grade Duster—Dusts Everything in Powdered Form—Built of the Finest Material and Made to Stand Long, Hard Service—Will Dust Under Side of Leaves or at Any Angle \$1.25 each.

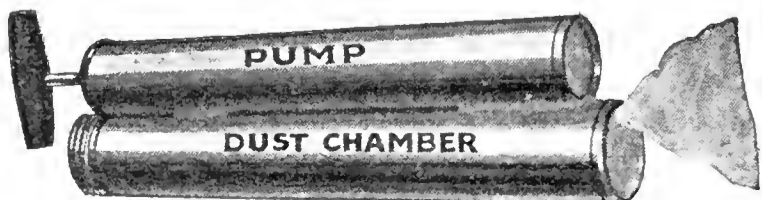

The Double Barrel Duster. For spraying all dry insecticides. 75c each.

Hand Garden Tools and Seeders

NO. 301 DOUBLE AND SINGLE WHEEL HOE.

In cultivating onions, beets, turnips, radishes, etc., it is invaluable; saves hours of hard labor. One great advantage which this double wheel hoe possesses is that it can be made into a single wheel hoe in a moment's time. An axle is sent with every double wheel hoe for this purpose. The wheels are 16 inches high. Price \$10.00.

No. 303. The same tool as 301 without vine lifters, cultivator teeth or plows. Side hoes only, \$8.00.

No. 313. The same tool as 301 without plows or vine lifters. Side hoes and four cultivator teeth only. \$9.00.

THE NEW MODEL SEED DRILL

This we consider the simplest and best drill on the market. The diamond-shaped adjustable hole regulates the discharge, and can be made larger or smaller as occasion requires. It has a broad wheel and a covering roller. The opening plow is adjustable in depth. Price \$14.00.

NO. 19C SINGLE WHEEL CULTIVATOR AND PLOW

The distinctive feature of this tool is the high steel wheel measuring 24 inches with land-side plow, scuffle hoe and cultivator teeth, complete. \$5.50.

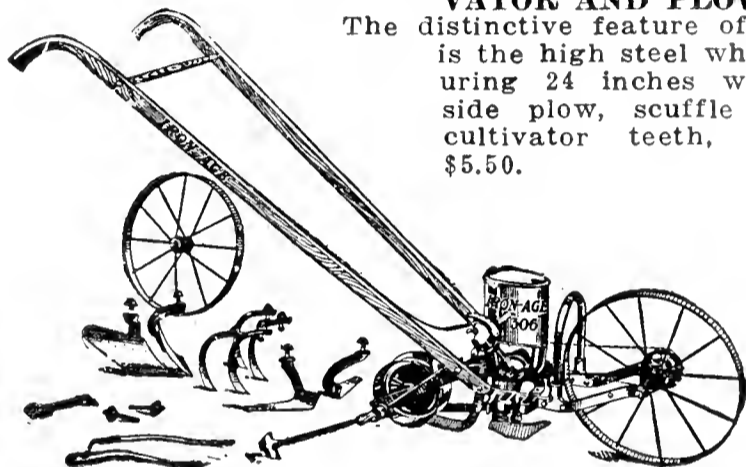

NO. 306 COMBINED HILL AND DRILL SEEDER DOUBLE AND SINGLE WHEEL HOE

Many men should use combination tools for two reasons: They save in first cost and they take up less room.

Thousands of gardeners have found this to be true of No. 306. Complete \$20.00.



OHIO SINGLE WHEEL HOE and CULTIVATOR.

Complete with 1 set of 5 cultivator teeth and 1 pair side hoes. Price \$4.00.

Jim Dandy Sprayer

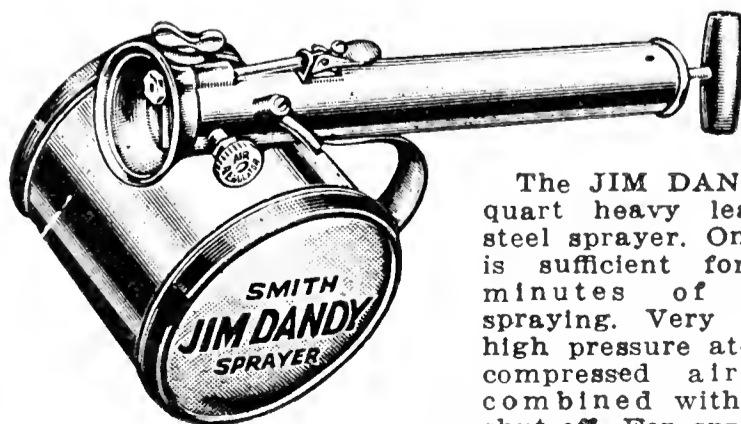

The JIM DANDY is a 3-quart heavy leaded sheet steel sprayer. One pumping is sufficient for several minutes of continuous spraying. Very powerful, high pressure atomizer and compressed air sprayer combined with automatic shut-off. For spraying flowers, roses, vines, shrubs, small trees, garden vegetables. Has air regulator valve for obtaining coarse spray or fog mist, light or heavy as desired. Price \$3.50.

PRICES. ALL PRICES ARE NET WITHOUT DISCOUNT AND SUBJECT TO CHANGE WITHOUT NOTICE.

THE NEW NORCROSS GARDEN GROWER

It Plows—It Weeds—It Cultivates—It Mulches

Positively banishes the back-breaking drudgery and work of garden planting, weeding, cultivating, and mulching, by performing these operations in a quick, easy way, without bending, kneeling, stooping, pulling, tugging or hand hoeing.

Simple to Operate—Well Made

Advantages—Destroys weeds that infest the garden and rob plants of moisture and nutriment—rids gardens of injurious insects attracted by weeds—keeps soil mellow and increases garden yield—works in all kinds of soil. Leaf guards permit all-season use by protecting large or overhanging leaves from wheel movement.

Complete as illustrated. Made in two sizes:

- No. 8—8 in. wide. Price complete\$6.50
- No. 10—10 in. wide. Price complete 7.50

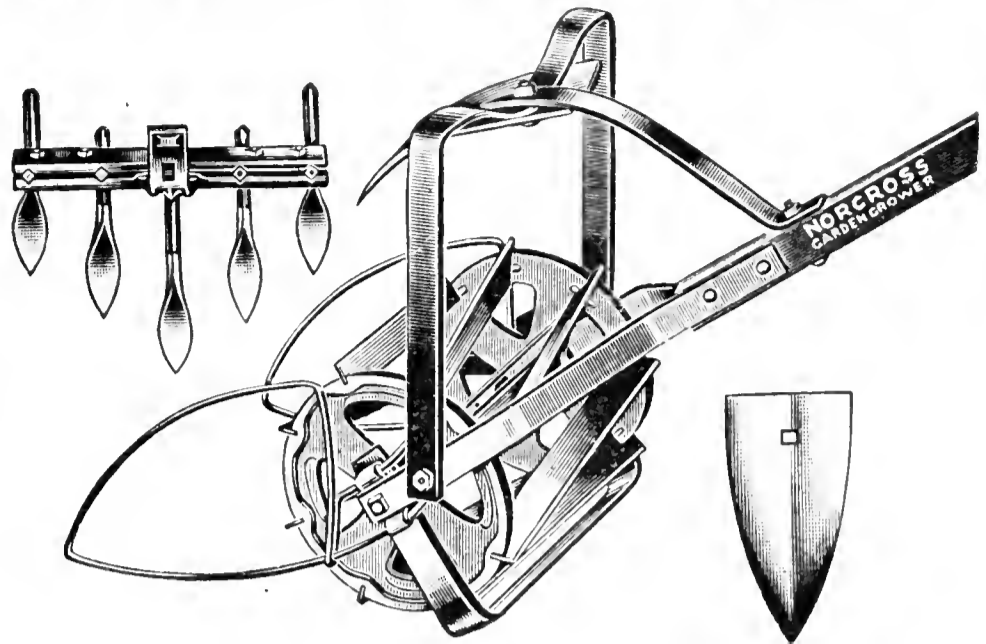

COLDWELL — LAWN MOWERS — MOTOR

COLDWELL CUB

21-inch Cut. Capacity Two to Three Acres Per Day.

SIXTEEN SPECIAL FEATURES

- | | |
|---|---|
| <ul style="list-style-type: none"> 1—Rolls and mows simultaneously. 2—Trims clean around trees, shrubbery, along walks, etc. 3—Machine may be used for rolling only. 4—Produces a smooth, velvety turf. 5—Negotiates grades with ease. 6—Simple and economical to operate. 7—Extremely flexible for trimming. 8—Full width, two-section drive roller. 9—Norman Hoffman self-aligning ball bearings. 10—Three speed control. | <ul style="list-style-type: none"> 11—Simple, powerful four cycle water cooled motor. 12—Engine automatically lubricated. 13—Alemite-Zerk force-feed lubrication. 14—Clutches and transmission entirely enclosed. 15—Spring loaded clutches require no adjusting and release automatically. 16—Entire machine, including the motor, designed and built by Coldwell. |
|---|---|

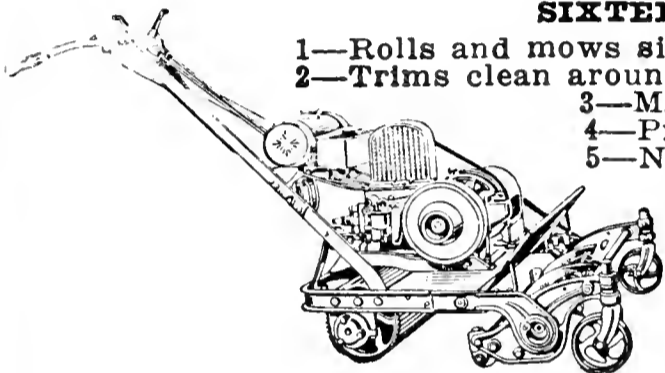

THE NEW SUPER TWIN CYLINDER LINE

25-inch and 30-inch Cut.

Suitable for lawns of from four to eight acres, also for baseball parks and athletic fields. Extreme flexibility for trimming and for terrace work. Equipped with two cylinder, four cycle water cooled motor, which provides an abundance of reserve power. Is free from vibration and noise and will develop maximum power continuously in hot weather without overheating. Full width, two-section drive roller with differential between the rollers to prevent marring and to make turning easy. Riding sulky for the operator, and grass catcher may be had as extra equipment.

SUPER "L TWIN"—25-inch cut, 4 to 6 acres per day.

This model may also be furnished with two 20-inch auxiliary gang units, which more than double the cutting capacity. These units may be attached or detached in a moment.

SUPER "L TWIN" WITH GANG—60-inch cut, 10 to 12 acres per day.

SUPER "TWIN 30"—30-inch cut, 6 to 8 acres per day.

Side View Illustration Super Twin "60" With Two Gangs and Riding Sulky.

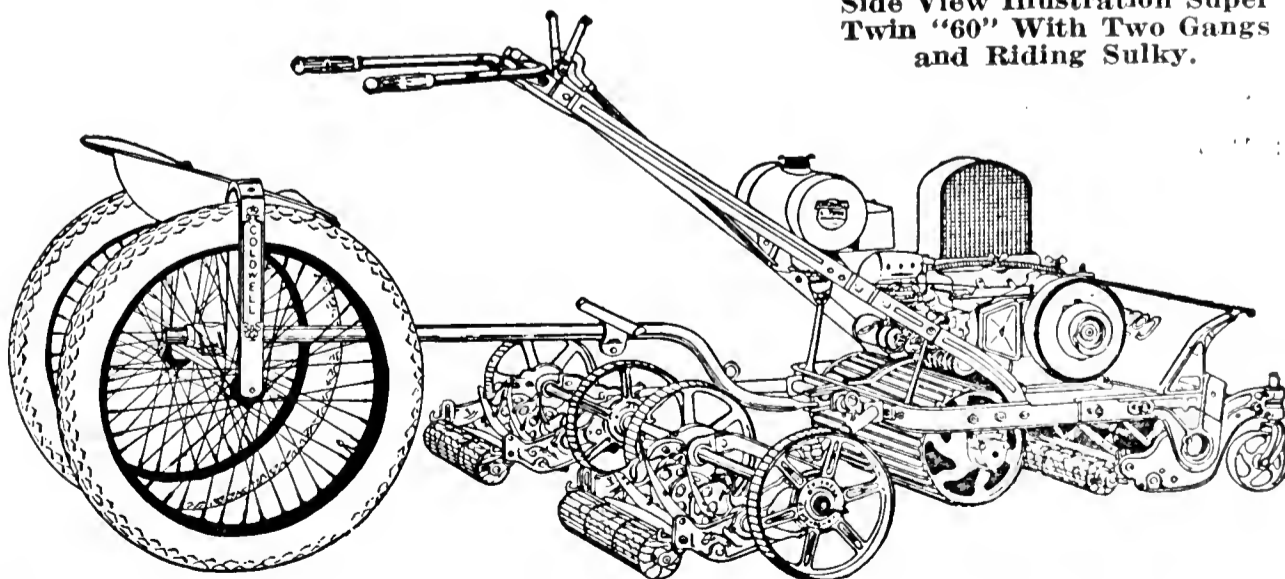

"Coldwell's Red Top"

New wheel type, 21-inch power lawn mower (not illustrated). This mower has the same type engine as is on the Cub, with the exception that it has a throttle control instead of a governor control. The clutches are the regular flat disc type, one for the revolving cutter and one for the drive wheels. It has a 5-blade revolving cutter. The wheel section is built with a differential, which will permit the mower to turn easily and without digging up the lawn.

We also have this mower equipped with pneumatic tires, namely, the "Red Top De Luxe."

Owing to limited space, we cannot fully describe these machines in our catalog, but will gladly mail a descriptive circular upon request.

OWING TO UNCERTAIN MARKET CONDITIONS WE WERE UNABLE TO QUOTE PRICE AT TIME CATALOG WAS PRINTED. PRICES QUOTED ON REQUEST.

LAWN MOWERS—HAND

AMBASSADOR DE LUXE. Coldwell's latest high grade quality lawn mower with modern improvements. It is quiet and easy running. Especially useful as a general all-purpose machine for well-kept lawns and requires minimum attention. Very popular mower among gardeners and for parks and cemeteries. Is equipped with 10-in. diameter wheels with pneumatic tires carried on roller bearings, adjustable for end play. Guard roller is rubber covered and carried on ball bearings mounted in roller hanger. Revolving cutter is 5-blade, equipped with Norma-Hoffman ball bearings. 14 in., \$20.00; 16 in., \$22.00; 18 in., \$24.00; 20 in., \$26.00.

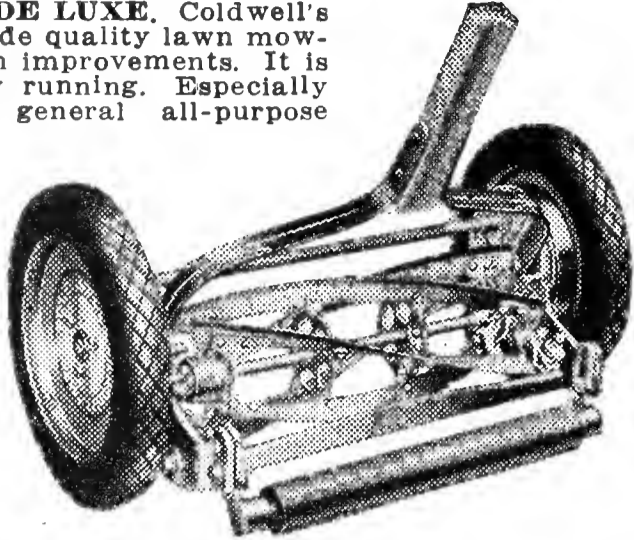

COLDWELL IMPERIAL. 5-blade, high wheel, equipped with improved Norma-Hoffman self-aligning ball-bearings. For use in cemeteries, parks, and private estates, where they are expected to do heavy work. 16 in., \$20.00; 18 in., \$22.00 each. With solid rubber tires \$2.00 extra.

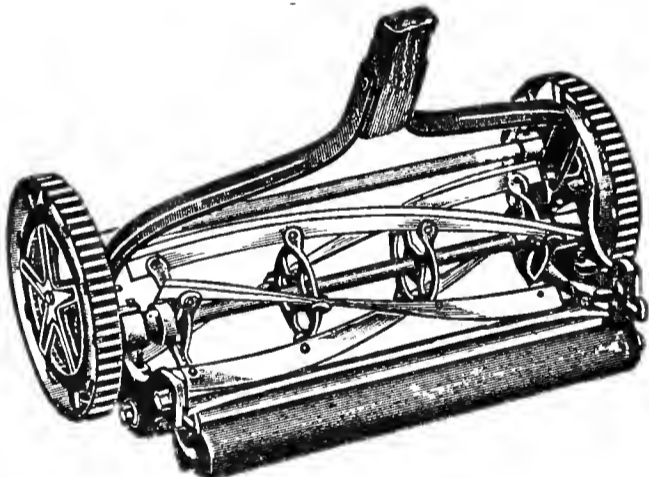
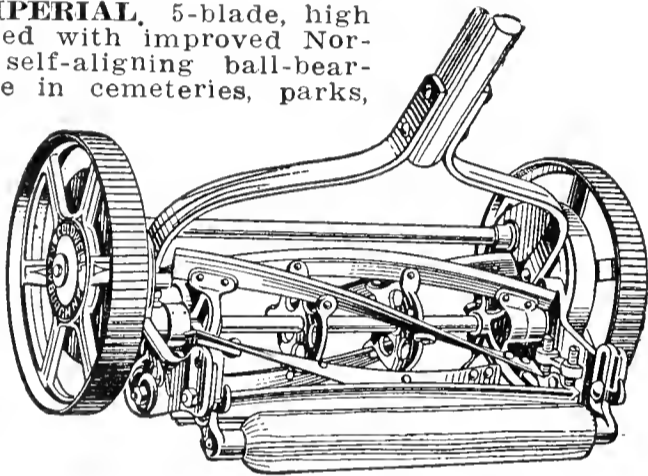

COLDWELL CRUSADER (BALL BEARING). A light-weight, 5-blade mower, designed to meet the demand for a machine of lighter construction at a moderate price. 14-in., \$7.00 each; 16 in., \$7.50 each; 18 in., \$8.00 each.

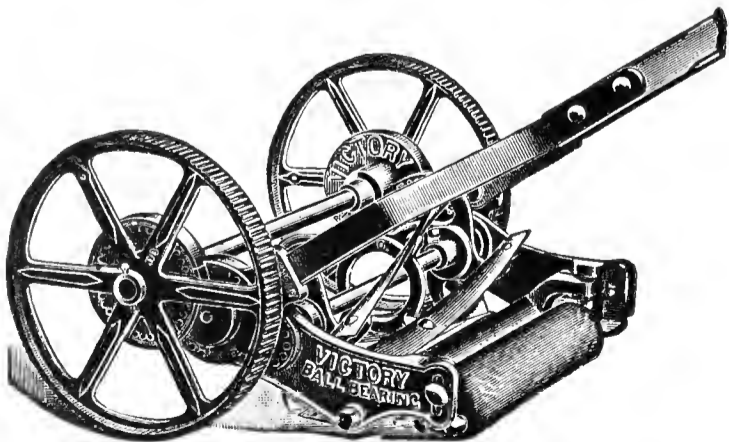

VICTORY BALL-BEARING LAWN MOWER. 10 in. wheel, 4-bladed reel, (triple gear), easily run and almost silent. 14 in. \$16.00, 16 in. \$18.00, 18 in. \$20.00, 20 in. \$22.00.

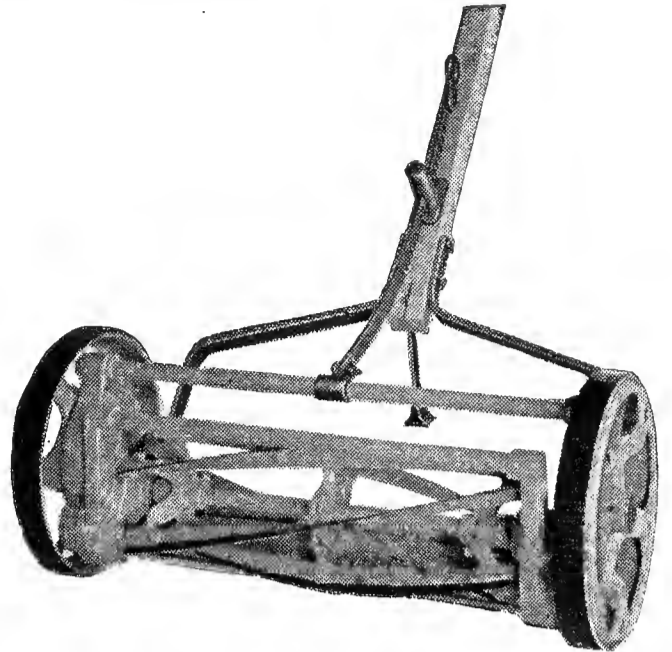

OHIO REVERSIBLE PUSH-PULL LAWN MOWER. An entirely new principle in lawn mower design. It cuts when you push; it cuts when you pull. It is a forward type cutting lawn mower with flexible ground bar and reel hung in front of center, instead of rear. It will cut close to any object. Can be pulled instead of pushed by reversing handle. With handle reversed, it is specially adapted for terrace cutting or for trimming under bushes, without injury to foliage. Can be adjusted in a fraction of a second to cut grass extremely high or very low. It has 10 in. drive wheel and 5-blade revolving cutter. 16 in., \$20.00 each; 18 in., \$22.00 each.

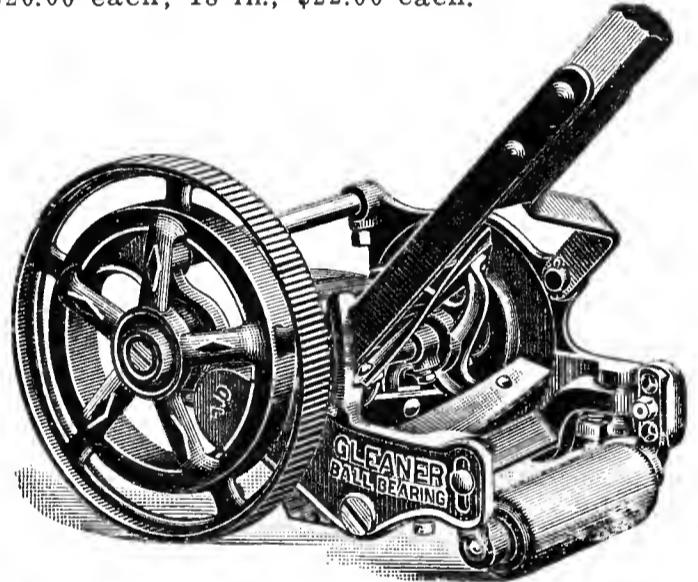

TOWNSEND'S "GLEANER" BALL BEARING. Strong, light and powerful. Only $\frac{1}{8}$ in. of metal between ends of blades and any obstruction to be cut around. 9-in. wheel, 4 blades. Width of cut 8 in., \$9.00 each; 10 in., \$10.00 each.

GRASS CATCHERS. Will fit any style of lawn mower. 14 in. and 16 in. \$1.50 each; 18 in. and 20 in. \$2.00 each.

Lawn Mower Service Department

This department, which we have featured for many years, is located in our building, and operated by skilled mechanics.

With its improved facilities for resharpening, repairing, and adjusting hand, horse, and motor mowers, we solicit your patronage. To insure seasonable delivery, early shipments are suggested. Please note what you especially wish done to your mower, on the tag or by letter. In cases where this is omitted, we will sharpen same and put in perfect condition.

Lawn Sprinklers

Model G Rain King

Throws any known kind of spray over circle 12 to 65 feet on normal pressure. A quarter of a turn of the nozzle gives you any kind of a close-in or far-out spray you want. This utterly new type sprinkler can be set to revolve very slowly for good soaking downpour without stalling even in high wind, on slopes, etc., or faster, if desired, for light spray on flowers, seeded beds, etc. New disc type, easy to move base. Simple, strong, it will last a life-time. Rich and distinctive in appearance. Brass arm, upright and nozzle mounted on rich green enamel base. Price, \$3.50 each.



Model E Rain King

For golf courses, estates, parks, etc. This Model E has a spinning vibrator that prevents stalling even on hillsides or in high winds. Here is a sprinkler that, at any given pressure, will throw more water, and throw it farther than any other sprinkler we know of. It spreads the water evenly throughout the entire watered area. Quickly set for fast or slow turning. Beautiful in appearance, sturdily built, and will last and perform well for many a year. Price, \$17.50.

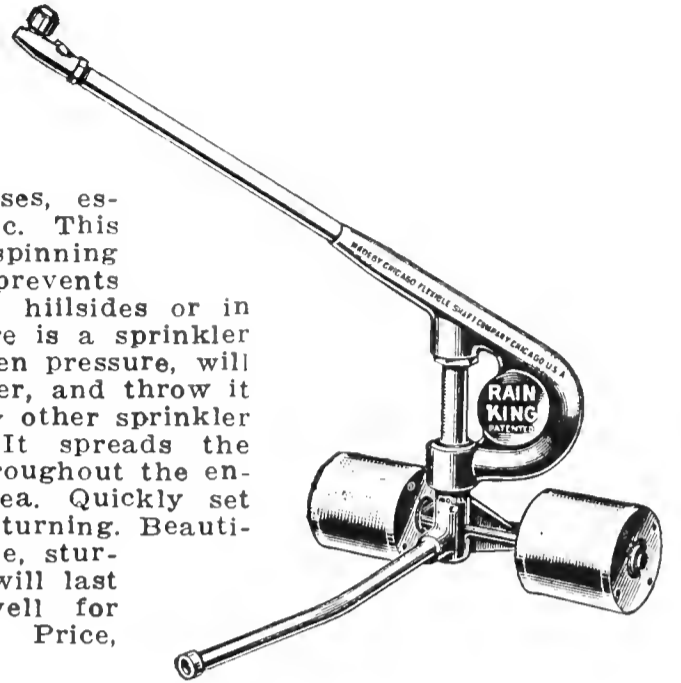

Rain Wave

The Rain Wave sprinkler embodies the Skinner System principles of watering. Covers about 60 feet by 60 feet, with 35 pounds pressure. Beautiful in operation. Built for many years service. Very popular with private estates and golf clubs. Circular on request. Price, \$37.50.

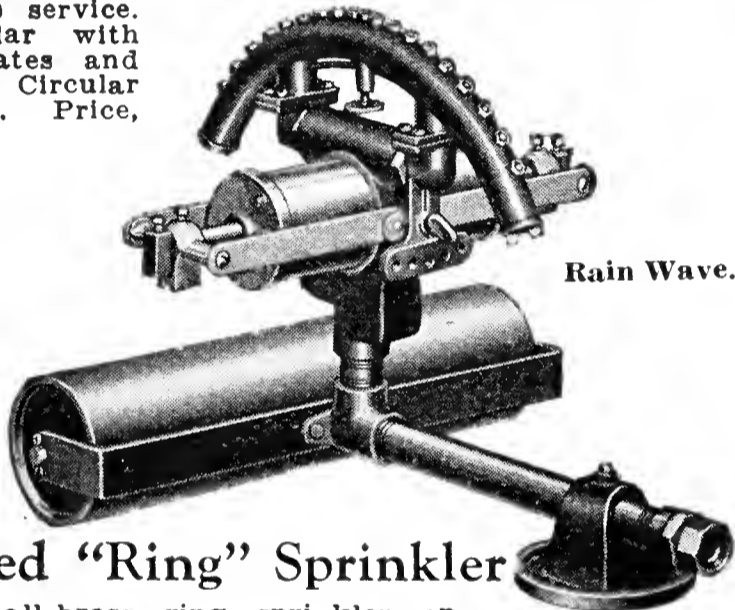

Rain Wave.

Improved "Ring" Sprinkler

Heaviest all-brass ring sprinkler on the market. Waters circle 30 to 40 feet in diameter. Price \$1.00 each.

Frog Sprinkler

A realistic appearing ornamental lawn sprinkler that throws a spray 4 inches high and 4 1/2 inches wide. Finished in green with black spots and white throat. Ornamental for rock gardens. Price, \$1.00 each.



Water Ballast Lawn Roller

Adapted for rolling lawns, golf courses and tennis courts. Light running, round edge. No tearing up of sod. Scraper to keep surface clean.

Roller bearings in the following sizes:

No.	Diam. Inches	Length Inches	Filled		Price
			Weight Empty	Weight with Water	
602	18	24	85	265	\$17.00
603	24	24	110	420	20.00
604	24	32	130	566	23.00
Plain bearings in the three sizes below.					
605	14	24	68	175	12.00
606	18	24	82	265	14.00
607	14	15	50	115	11.00



Model D Rain King

The latest Rain King. Most beautiful in appearance and exceptionally efficient on all water pressures or any spray. Fitted with latest patent Rain King nozzles which require just a touch to adjust for any spray or direction. Has double brass water column, wide spread base with exceptionally easy hose coupling. Finish, red and brass; height, 9 inches. Price, \$2.25 each.

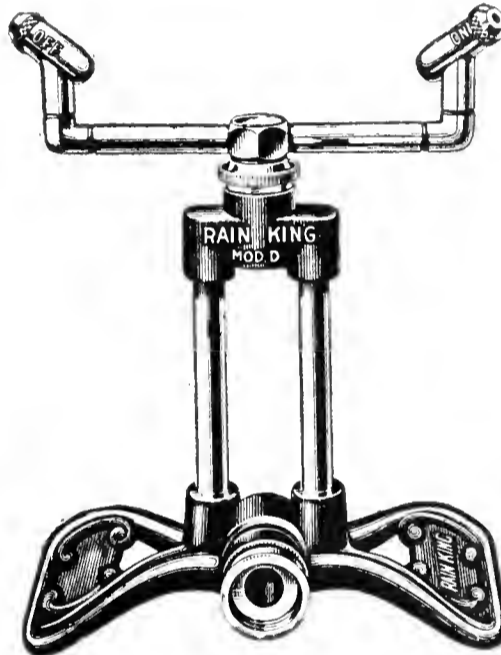

Rip Sprinkler

"The Master Rainmaker" (Not illustrated)

A self adjusting, simple, and economical lawn sprinkler; will not clog or corrode.

Just stick the spike in the ground, turn on the water and see the 150-foot (60 ft. diameter) circle of perfect Raindrops. Will operate efficiently on as low as 5 pounds pressure.

Three Types

No. 1 Spike and No. 2 Irrigation, 75c each. Connection type No. 3. \$1.00 each.

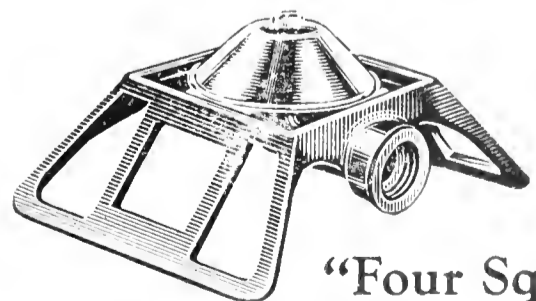

"Four Square"

This new sprinkler fits in with today's economy trend. Sprinkles SQUARE AREAS (about 18 by 18 feet with normal water pressure), eliminating waste, as it is not necessary to resprinkle, where circle sprinkling overlaps. A fine spray is thoroughly and evenly distributed. This sprinkler has a cast iron base and the top is polished stamped sheet brass. Height, 3 1/2 inches. Price, \$1.00 each.

Farm and Garden Tools and Implements

We carry in stock Cultivators, Harrows, Planters, Seeders, Hoes, Mowers, Rakes, and Tedders, some of which are described and illustrated herein. Circulars fully describing our various implements will be mailed upon request.

CULTIVATOR, McCORMICK-DEERING

McCormick-Deering 1-horse cultivators can be supplied in 5-, 7-, and 9-shovel and 14-tooth, with a variety of special equipment that adapts them to the needs of those sections where the work is done with one horse. For the cultivation of all farm and garden crops. Prices on application.

HARROW, McCORMICK-DEERING, SPRING TOOTH, WITH LEVERS

	Price
9-tooth, 1 horse, with handles, weight 126 lbs.	\$20.00
15-tooth, 2-horse, two sections, weight 210 lbs.	26.00
17-tooth, 2- or 3-horse, two sections, weight 228 lbs..	28.00
Sulky attachment for 15- and 17-tooth Harrows....	14.00

HARROW, McCORMICK-DEERING DISC
made with a much stronger frame than the ordinary type disc harrow, being made of a heavy angle steel cross-bar to which draft links are fastened. Made with either solid or cutaway discs. It is made in different sizes for horses or tractors. Can be supplied with fore carriage and transportation trucks or separate if desired. Prices on application.

HARROW, McCORMICK-DEERING PEG-TOOTH

This harrow can be used with great success on stony ground. Teeth can be quickly set at any desired angle by the lever. One section, with evener, for one horse, \$13.00; two sections with evener, for two horses, \$25.00.

MEEKER SMOOTHING DISC HARROW

Designed especially for market gardeners' work. A perfect harrow and land-roller combined. The frame measures 6 ft. 8 in. by 6 ft., and has four sets of rollers, having 58 steel discs 8 in. diameter on them. The discs grind all the lumps so fine that the seed must come up, leveling and leaving the land fine and smooth and does its work far better than the rake. Price. \$40.00.

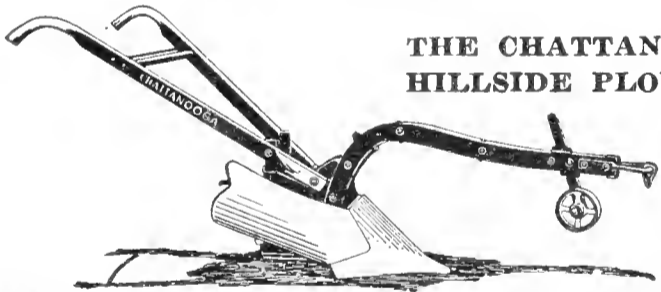

THE CHATTANOOGA STEEL HILLSIDE PLOW

They are the result of years of experiment and for strength, lightness and

ease of draft cannot be equaled; while intended for hillside work, will do equally as good work on level land.

No. 208. 1-horse plow with wheel.....	\$18.00
No. 209. 2-horse plow, complete with cutter or jointer	28.00

THE COMBINATION STEEL BEAM LANDSIDE PLOW

The latest and most up-to-date steel landside plows on the market. Furnished with jointers or cutters, as desired.
No. 97. Regular 2-horse, complete\$30.00
No. 100. Regular 2-horse, same as above, but with shorter beam. Specially adapted for stony ground.
Complete 30.00

THE ORIGINAL 76 WOOD BEAM HILLSIDE PLOW

This pattern of the popular A. B. C. Series is of light weight and thoroughly constructed. Handles can be raised or lowered. Has automatic cutter, shifting lever clevis and a spring foot latch. Two sizes.

B. Regular 2-horse, complete with wheel and cutter.	\$26.00
C. 1-horse, complete with wheel	18.00

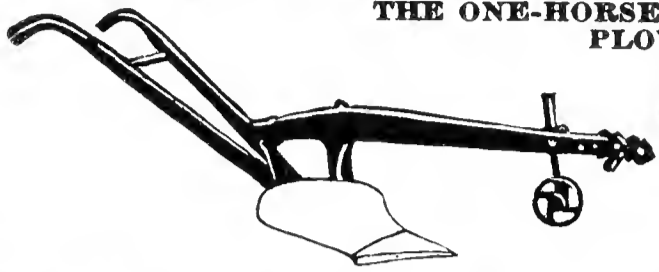

THE ONE-HORSE WOOD BEAM PLOW

Beam adjustable so that the horse can walk on the land or in the furrow.

No. 52. Grey's Special. Regular 1-horse plow with wheel\$18.00

THE VINEYARD AND GARDEN PLOW

Chilled wearing parts. Horse can walk in the furrow or on the land. Handles can be adjusted sideways or up and down. Iron beam, 1-horse, with wheel \$15.00.

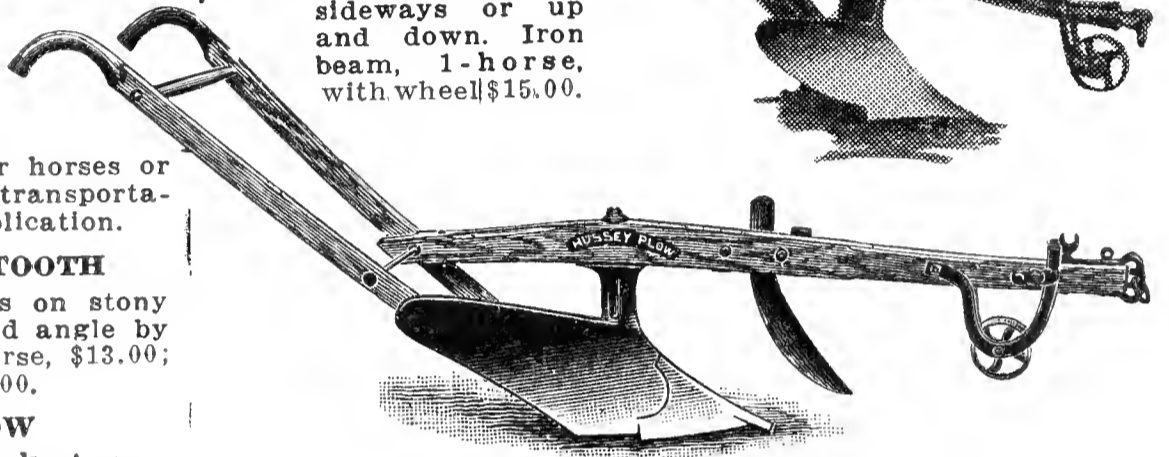

PLOWS, HUSSEY HARD METAL

No. 100. 1-horse. Furrow 5 to 6 in. deep, 10 in. wide.	\$16.00
No. 102. Light 2-horse. Furrow 5 to 7 in. deep, 12 in. wide	19.00
No. 104. Medium Sward. Furrows 8 in. deep, 16 in. wide	25.00

AMERICAN STEEL DRAG SCRAPER

Our late addition of a steel drag scraper is of an improved pattern and made without seam or lap, pressed from a single plate of steel. The bowl is well rounded at the sides and curved upward to form the back. They are strong and substantial and made in two sizes. No. 1, 7 cu. ft., \$12.00; No. 2, 5 cu. ft., \$11.00.

7½-FT. HORSE WEEDER

By the use of weeders much time and labor are saved, and better crops grown. They will not cut the roots of the crop, but cultivate just deep enough to retain the moisture where it is most needed. Price, \$18.00.

THE SHOVEL POTATO HOE

It is made to meet the demands of large growers of potatoes, being designed both for hilling and covering purposes. Price, \$18.00.

KING OF THE CORNFIELD CORN PLANTER AND FERTILIZER DISTRIBUTOR COMBINED

For planting field or ensilage corn, beans, peas or beet seeds, in hills or drills with check. Price, \$45.00.

FERTILIZER SOWER, THE STEVENS' HAND

Does the work perfectly, sowing all kinds of lawn dressing and other commercial fertilizers, wood ashes, lime, etc., in large or very small quantities. Price \$25.00.

NORTHLAND STONE BOATS AND HEADS

Strongly bolted. Heavy woodwork; made in two sizes; 6 ft. by 29 in. and 7 ft. by 32 in. Heads are steel. The wood part is made from rock maple and the whole is thoroughly well bolted, making the very best pattern of stone boat. Prices: 6-ft. boat, complete \$15.00; 7-ft. boat, complete \$20.00; 29 in. head only, with bolts, \$5.00; 32 in. head only, with bolts, \$8.00.



Insecticides and Fungicides

ALL PRICES SUBJECT TO CHANGE WITHOUT NOTICE

Ant Trap "Tat." Destroys all species of ants. Trap contains two baits attracting both SWEET and GREASE eating ants. For house or garden. Metal container with non-fluid bait. Each 25c.

***Aphine.** For the destruction of the green, black and white fly, thrips, red spider, mealy bug, caterpillars, scale, etc. Qt. \$1.00, gal. \$3.00.

***Arsenate of Lead (Dry).** Lb. 25c, 5 lbs. \$1.00, 25 lbs. \$4.00.

***Black Leaf 40 (Sulphate of Nicotine).** A concentrated liquid for use in destroying green aphids and thrips. Oz. bottle 35c, 5 ozs. \$1.00, lb. \$2.25, 2 lbs. \$3.25, 5 lbs. \$5.85, 10 lbs. \$10.60.

***Bordeaux Mixture, Dry.** Can be used either dry as a dust or mixed with water as a spray for all fungous diseases. 1 lb. to 5 gals. of water. 1 lb. 25c, 4 lbs. 80c, 25 lbs. \$4.00.

Bye, Bye, Blackbird. A safe remedy for the user, but sure to rid cornfields of crows, blackbirds, etc. ½ pt. 65c, pt. \$1.00.

Carbola. A combined disinfectant, insecticide and cold water paint. Unexcelled as a whitewash. 5 lbs. 75c, 10 lbs. \$1.25, 25 lbs. \$2.75, 50 lbs. \$5.00.

***Copper, Ammoniated Solution of.** A liquid fungicide, ready for use. Dilute at the rate of 1 qt. to 25 gals. of water, and spray lightly. Qt. \$1.50, gal. \$4.60.

***Creosote, Gypsy Moth.** For the destruction of the eggs of gypsy moth. Qt. 50c, gal. \$1.25, 5 gals. \$5.00.

***Cyanogas (Calcium Cyanide).** "Grade A." Will destroy rats, ground hogs, etc. ½ lb. 45c, lb. 75c, 5 lbs. \$3.00.

Formacide. Formaldehyde Dust Triple Strength Seed and Soil Disinfectant. For control of damping-off. Full directions on request. ½ lb. 45c, 1 lb. 75c, 5 lbs. \$2.00.

Cyanogas (Grade G). Fumigant. 5 lbs. \$3.00, 25 lbs. \$10.00.

***Fungtrogen.** An effective and scientific preventive and remedy for mildew, black spot and many fungous diseases of Roses and other plants. Pt. \$1.25, qt. \$2.00, ½ gal. \$3.50, gal. \$6.00.

Grape Dust. For destroying mildew on grape vines and trees affected with mold, mildew or rust mites. 5-lb. pkg. \$1.25.

***Lemon Oil.** A safe and effective insecticide for all insects and soft scale, highly recommended for house plants. Qt. 85c, gal. \$2.50.

***Lime-Sulphur Solution.** Will completely destroy San Jose and other scale. Qt. 50c, gal. \$1.00, 5 gals. \$3.50, ½ barrel, about 30 gals., 50-gal. barrels, price on application.

***Lime and Sulphur, Dry.** For dormant spraying of fruit; used for same purposes as Liquid Lime-Sulphur, but is much easier to handle. 1 lb. 30c, 5 lbs. \$1.25, 12½ lb. bags \$2.00.

Nico-Fume Tobacco Paper. (Registered). For fumigating greenhouses. Positively the strongest Tobacco Paper on the market. 24 sheets \$1.25, 144 sheets \$4.50, 288 sheets \$8.00.

Nico-Fume Powder. For fumigating. 5 lbs. \$3.35, 10 lbs. \$5.85.

Nico-Fume Pressure Fumigator. The new way. Much more effective than the old loose-piles method. ½-lb. can 45c, 1-lb. can 75c. Larger quantities price on application.

***Pomo-Green with Nicotine.** The Leaf Green All-in-one Dust or Spray. A single material used as a dust or spray; for all leaf-eating or sucking insects, and aphids. Also diseases on Roses, flowering plants and shrubs without being conspicuous on foliage. 1-lb. can 75c, 5-lb. can \$3.00.

***Pyrox, Bowker's, The New Improved.** The one best spray for all leaf-eating insects and fungous diseases. All ready to use by adding water. 1 lb. 50c, 5 lbs. \$1.75, 10 lbs. \$3.00, 25 lbs. \$5.00.

***Richard's X L Liquid Insecticide.** Destroys mealy bug, red spider, etc. Qt. \$3.00, gal. \$10.50.

Scalecide. The most reliable and economical remedy for San Jose scale and all fungous diseases. Qt. 65c, gal. \$1.55, 5 gals. \$5.50, 10 gals. \$9.50.

Rotenone Dust. Efficient control of chewing insects. Non-poisonous. Highly recommended for bean beetle, cabbage worm, etc. 1 lb. 30c, 5 lbs. \$1.25, 25 lbs. \$5.00.

Semesan. Semesan may be applied in dust or liquid form to the seed before planting. It is harmless to seed but deadly to disease organisms which may be on the seed. 1 oz. treats 15 lbs. of seeds. Effective in controlling damping off. 2 ozs. 35c, lb. \$2.25, 5 lbs. \$9.90.

Slug Shot, Hammond's. Destroys insects injurious to house and garden plants, vegetables and fruit of all kinds. Directions for use on each package. 1 lb. 25c, 5-lb. pkg. \$1.00.

Snarol. For cutworms, snails, etc. Broadcast on the ground under the plants. 1½ lbs. 35c, 4 lbs. 85c, 15 lbs. \$3.00, 50 lbs. \$8.00.

***Soap Spray, "Imp."** It contains vegetable poisons, harmless to plants, but peculiarly effective against red spider on fruits, etc., the Rhododendron fly. Qt. \$1.00, gal. \$3.00, 5 gals. \$12.00, 10 gals. \$20.00.

Soap, Fish Oil. Is a most effective preparation for destroying San Jose scale, plant lice and all sucking insects. 1-lb. box 35c, 5-lb. box \$1.40.

Sulphur Flour. Useful for fumigating. Lb. 10c, 5 lbs. 40c, 10 lbs. 75c, 25 lbs. \$1.75, 100 lbs. \$6.50.

***Thrip Juice No. 2.** Very effective in destroying thrips on Grapes, aphids, red spider, mealy bug, and other sucking insects. Qt. \$1.25, gal. \$4.80.

Tobacco Dust. For aphids, etc., on the foliage and around the roots. Lb. 15c; 5 lbs. 50c, 25 lbs. \$2.00, 50 lbs. \$3.50, 100 lbs. \$6.00.

Tobacco Stems. Small quantities. Lb. 5c, \$1.00 per bbl. Large bales or cases, lb. 4c.

***Vermine.** A soil sterilizer and germicide for all soil vermin, such as cut, eel, wire and grub worms, slugs, root lice, maggots and ants. Used in the greenhouse, garden and field, and protects your crops and lawns against the ravages under soil. Qt. \$1.00, gal. \$3.00.

Volck. One of the most powerful insecticides known for the control of red spider and scale. Volck is non-poisonous. Must not be used in connection with lime or sulphur. Qt. \$1.00, gal. \$3.00.

***Wilson's O. K. Plant Spray.** A contact spray for Roses, Chrysanthemums, Carnations, Grape vines (when dormant), etc. Qt. \$1.00, gal. \$3.00, 5 gals. \$12.00, 10 gals. \$22.00.

***Weed Exterminator, "Herbicide."** Is a powerful chemical solution for destroying weeds and vegetation of all kinds on roadways, paths, gutters and tennis courts.

1-qt. can\$0.50 5-gal. can\$ 6.00
1-gal. can 1.50 10-gal. can 10.00

Hammond's Liquid Slug Shot

A safe, economical, combined pyrethrum and rotenone spray. Kills all insects, and especially effective against mealy bug, and also fungous diseases. One ounce makes six gallons. 1 oz. 35c, 6 ozs. \$1.00, 16 ozs. \$2.25, qt. \$4.00, gal. \$12.00.



Red Arrow is a contact insecticide particularly adapted for flowers, fruits and vegetables. It kills both chewing and sucking insects and is especially recommended for the control of Mexican bean beetle and Gladiolus thrip, as well as aphids, leaf hoppers, etc. A very important thing about Red Arrow is that it is economical, combining the highest killing power with the greatest coverage. Oz. 35c, 4 ozs. \$1.00, pt. \$2.50, qt. \$4.00, gal. \$12.00.

McCloud's Red-Squill Rat Exterminator. Kills rats. A few drops on bread. Safe to use anywhere. Not a poison. Large size makes 100 baits, price \$1.00. Small size makes 50 baits, price 60c.

AGRICULTURAL CHEMICALS and FERTILIZERS

Grey's 9-6-6 Plant Food for Lawns, etc.



Grey's Plant Food contains the necessary ingredients to feed your lawns, flowers, trees and shrubs.

Grey's Plant Food is a "complete" fertilizer, odorless, easy to handle and free of weed seeds.

Grey's Plant Food meets all the plant food requirements to promote a rich, luxuriant growth and an abundance of foliage and bloom.

Grey's Plant Food is adapted to lawns, golf courses and gardens. Also may be used on trees and shrubs with splendid results.

Directions for use in every package.

10 lbs.	\$0.75	50 lbs.	\$2.75
25 lbs.	1.60	100 lbs.	4.50
Ton	\$80.00		

Salt. Top-dressing for lawns and Asparagus beds. Price per bag about 140 lbs. \$2.50.

Soot, Imported Scotch. Prevents mildew when mixed with sulphur at the rate of one-third sulphur and two-thirds soot; also a good fertilizer. 10 lbs. \$1.00, 100 lbs. \$7.00.

Sulphate of Ammonia 20.56 per cent nitrogen. \$4.00 per 100 lbs.

Shredded Cattle Manure. 100 lbs., \$3.25.

Special Ground Bone. An excellent material for use where gradual but long continued effects of nitrogen and phosphoric acid are desired, as under and around perennials, trees and shrubs, or before seeding to grass. 5 lbs., 35c; 10 lbs., 60c; 25 lbs., \$1.00; 50 lbs., \$1.75; 100 lbs., \$3.00.

Stockbridge Early Crop Manure, 5-8-7. A fertilizer especially adapted to soils lacking nitrogen and for use with all root and other vegetable crops. 100 lbs., \$3.00.

Stockbridge Potato and Vegetable Manure, 4-8-10. Well adapted to poor or lightly manured soils—especially for Potatoes, Beets, and for many foliage crops, except Cabbage, which requires considerably more available phosphoric acid. 100 lbs., \$3.00.

Adco

For making artificial manure. Dry leaves mixed with Adco and kept moist, turn into excellent manure. So do flower stalks, cuttings, pea vines and almost any other kind of non-woody vegetable waste. Adco is a powder which, mixed with vegetable matter and kept moist, turns the latter into real manure, but without odor, flies, etc.

In 25-lb. bags (Making 1/2 ton of manure) Each \$2.25
 In 150-lb. bags (Making 3 tons of manure) ... Each \$10.50
 In 7 1/2-lb. package (trial size) Each \$1.00



A Natural Organic Fertilizer

Dried cow manure (dehydrated) combining the chemical values of fertilizer with the organic values of manure. It is the natural plant food for lawns, flowers, etc.; is absolutely free from live weed seeds, and is clean, odorless, and convenient to handle. It can be applied without fear of burning or harmful results, and it contains all the essentials necessary for soil improvement and vigorous plant growth. Price \$1.50 per bag of 50 lbs.

"Wondergro"

New Life plant food tablets. 12-tablet pkg., 10c; 40-tablet pkg., 25c; 100-tablet pkg., 50c.

Naptoside

The New Fumigant-Insecticide Kills Thrips, Millepedes, Sow Bugs, and other insects of the soil. Also used to prevent fungous diseases. Apply one pound to 100 sq. ft. 25 lbs., \$4.00; 50 lbs., \$7.00; 100 lbs., \$13.00.

Tri-O-Gen Rose Garden Spray

Combined spray treatment, fungicide, insecticide, and plant stimulant. Combined as a Kit. Harmless to foliage or blooms. Small Kit, \$1.50; Medium Kit, \$4.00; Large Kit (makes 32 gallons), \$6.00.

Peat, Leaf Mold, etc.

Peat Moss (Imported). Coarse and fine, \$3.50 per bale. Trial bale, \$1.25 each.

Silver Sand. For mixing with potting soil, etc. Pk. 75c, bu. \$2.00.

Leaf Mold. Best quality. Bag \$2.50.

Moss, Live Sphagnum. Bu. \$1.50, bag \$3.50.

Moss, Dry Sphagnum. Bag \$1.50. Small bale \$6.50, large bale \$10.00.

Orchid Peat, or Fern Root. Best selected. Hand picked. Bu. \$1.75, 2 bu. bag \$3.00.

ALL PRICES SUBJECT TO CHANGE WITHOUT NOTICE

A. A. Superphosphate. 16 per cent soluble and available phosphoric acid. 100 lbs., \$1.75.

Ashes, Unleached Hardwood. High in potash. In bags, per 100 lbs., \$3.00.

Bowker's Market Garden Fertilizer, 4-8-4. For vegetables and small fruits where a good balance of the three plant foods is desired. A good, high-grade fertilizer to use where moderate applications of manure are occasionally made. 100 lbs. \$2.75.

Blood Tankage. 14 per cent. \$6.00 per 100 lbs.

Bon Arbor. Immediately soluble in water. A complete plant food, containing nitrogen, potash and phosphoric acid in sufficient quantities. 1-lb. pkg. making 30 gals., 75c; 5 lbs., \$3.00.

Bone, Coarse or Cracked. Ground coarse for Grape borders or poultry. 100 lbs. \$4.00.

Calcium Chloride. Dust layer and surface binder. 100 lbs. will cover about 50 square yards. 100 lbs. \$4.00.

Castor Pomace. Is an organic ammoniate used on lawns and golf courses. 100 lbs. \$2.50.

Clay's Fertilizers. This valuable imported manure is especially recommended to all who grow either fruit, flowers or vegetables and wish to bring them to the highest perfection. 14 lbs. \$2.50, 28 lbs. \$4.00, 56 lbs. \$7.50, 112 lbs. \$14.00.

Charcoal. Coarse and fine. 10 lbs. 50c, per 100 lbs. \$4.00.

Cottonseed Meal. Is being widely used by gardeners, florists, nurserymen, as well as on golf courses and vegetable gardens. 100 lbs., \$3.50.

Humus. Finely ground and screened for renovating lawns, golf courses, flower beds, etc. Improves potting soil. 100 lbs., \$2.00.

Lime, Agricultural. An unusually pure calcium lime, especially prepared for use on the soil. Shipped in the form of a dry powder in bags of 100 lbs. each. Per 100 lbs. \$1.00; ton, \$18.00.

Mowrah Meal. Used extensively for killing earthworms on lawns and putting greens. 100 lbs., \$4.50.

Muriate of Potash. 50 per cent actual potash. 100 lbs., \$4.50.

Nitrate of Soda (Reground). 10 lbs., 75c; 25 lbs., \$1.50; 50 lbs., \$2.50; 100 lbs., \$4.00.

Pulverized Sheep and Goat Manure. A. A. C. brand. This brand has no objectionable odor. It is pure natural manure and the most nutritious food for plants, lawns, wherever a strong, luxuriant growth is needed.

5 lbs.	\$0.40	50 lbs.	\$ 2.00
10 lbs.60	100 lbs.	3.25
25 lbs.	1.25	Ton	55.00

Pulverized Poultry Manure. 100 lbs., \$2.50.

INDEX

- | | | | | |
|---|--------------------------------------|--|--------------------------------------|-------------------------------------|
| Abutilon5, 71 | Brachycome 11 | Cypress, Japan ... 82 | Globeflower .. 38, 75 | Love-in-a-Mist ... 27 |
| Acacia 5 | Bridal Wreath... 18 | Dahlias15, 70 | Gloxinia 19, 70 | Lunaria 21 |
| Acanthus 5 | Broccoli 44 | Daisies 11, 14, 18, 19, 71, 75 | Gnaphalium 18 | Lupinus1, 23 |
| Achillea5, 72 | Broom 19 | Dandelion 50 | Godetia1, 20 | Lychnis ... 4, 24, 74 |
| Achimenes 5 | Browallia 11 | Daphne77, 83 | Gomphrena 19 | Lycium 80 |
| Achyranthes 71 | Brussels Sprouts 45, 62 | Datura 16 | Gourds 20 | Lythrum 24, 74 |
| Acidanthera 70 | Buckwheat 66 | Delphinium..1, 16, 73 | Grapes 85 | Magnolia 79 |
| Aconitum.....5, 72 | Buddleia 77 | Deutzia 77 | Grass Seeds ...63-65 | Maidenhair-Tree .. 79 |
| Acroclinium 5 | Bulbs67-70 | Dianthus 4, 16, 17, 73 | Grasses, Orna-
mental 40 | Mallow 24, 74 |
| Actinidia 80 | Buphthalmum 11 | Diascia 17 | Grevillea 20 | Malope 24 |
| Adiantum 18 | Cabbage ...41, 46, 62 | Dicentra 73 | Gumbo 53 | Malva 24 |
| Adumia 5 | Cacalia 11 | Dielytra 73 | Gypsophila.. 4, 20, 73 | Mangel Wurzel.45, 66 |
| Adonis 5 | Cactus 11 | Dimorphotheca .. 17 | Hardy Perennial
Plants72-75 | Maple 79 |
| Aethionema 4 | Caladium 71 | Dogwood77, 79 | Hardy Rock Gar-
den Plants 4 | Marigold .. 2, 24, 71 |
| Agatheia 5 | Calandrinia 4 | Dolichos 17 | Hawthorn 79 | Martynia 51 |
| Ageratum5, 71 | Calceolaria 11 | Doronicum .. 17, 73 | Heather 83 | Matthiola 24 |
| Agrostemma 6 | Calendula11, 71 | Dracaena 17 | Hedera 80 | Matricaria 24 |
| Ajuga 72 | Calliopsis 12 | Dracocephalum .. 17 | Hedge Plants..... 80 | Maurandia 24 |
| Akebia 80 | Callirhoe 12 | Dusty Miller 13 | Helenium 20, 73 | Meconopsis 24 |
| Alfalfa 65 | Campanula ..4, 12, 72 | Echinacea 17 | Helianthemum ... 20 | Mexican Dwarf
Orange 24 |
| Almond 77 | Candytuft ..13, 21, 74 | Echinocystis 17 | Helianthus 20 | Melons 41, 52 |
| Alonsoa 6 | Cannas 13, 70, 71 | Echinops 18, 73 | Helichrysum 20 | Mesembryanthemum
..... 24 |
| Alstroemeria 6 | Canterbury Bells 12, 72 | Echium 18 | Heliophila 20 | Mignonette. 24, 25, 71 |
| Alternanthera 71 | Caragana 78 | Edelweiss 18 | Heliopsis 73 | Millet 66 |
| Althea 77 | Cardinal Climber. 22 | Eggplant 50, 62 | Heliotrope 21, 71 | Mimosa 25 |
| Alyssum. 4, 6, 71, 72 | Cardoon 47 | Elm 79 | Helleborus 73 | Mimulus 25 |
| Amaranthus 6 | Carnation 16, 17 | Endive 50 | Hemerocallis 74 | Mina 25 |
| Amaryllis 6 | Carrot 41, 47 | English Ivy..... 80 | Hemlock 80, 81 | Mirabilis 25 |
| Ambrosia 6 | Castor-oil Beans... 32, 71 | Erigeron 18 | Herbs 62 | Mixtures, Hay 65 |
| Ampelopsis6, 80 | Catalpa 79 | Erinus 4 | Hesperis 21 | Mixtures, Pasture. 65 |
| Amygdalus 77 | Catchfly 35 | Eryngium 18 | Heuchera 21, 74 | Monarda 74 |
| Anchusa6, 72 | Cauliflower.41, 47, 62 | Erysimum 18 | Hibiscus... 21, 74, 77 | Montbretias 70 |
| Andromeda 83 | Celastrus 80 | Eschscholtzia ... 18 | Hollyhock 21, 74 | Morning-glory ... 22 |
| Anemone4, 6, 72 | Celery41, 48, 62 | Euonymus 77, 83 | Honesty 21 | Mountain-Ash .. 79 |
| Anthemis6, 72 | Celosia 13 | Eupatorium ...18, 73 | Honeysuckle .. 77, 80 | Mountain-Laurel. 83 |
| Anthericum 6 | Celsia 13 | Euphorbia 18 | Hop Vine 80 | Mulberry 79 |
| Antirrhinum..1, 7, 71 | Centaurea..13, 71, 72 | Evergreen Shrubs..83 | Horseradish ...50, 62 | Musa 25 |
| Apples 84 | Cerastium13, 72 | Evergreen Trees
..... 81, 82 | Humulus 21 | Mushrooms 53 |
| Aquilegia..1, 4, 7, 72 | Cheiranthus ...14, 73 | Exacum 18 | Hunnemannia 21 | Muskmelon .. 41, 52 |
| Arabis7, 72 | Chelone14, 72 | Farm Seeds 66 | Hyacinthus 70 | Musk Plant 25 |
| Aralia 77 | Cherries 84 | Fennel 50, 62 | Hydrangea 77 | Mustard 53 |
| Arbor-Vitae ... 80, 81 | Chervil 47 | Ferns 18 | Iberis 21, 74 | Myosotis 25, 74 |
| Arctotis 7 | Chicory 47 | Fescue 64 | Ice Plant 22 | Myrsiphyllum 35 |
| Arenaria 4 | Chionanthus 77 | Fetticus 50 | Impatiens 22 | Nasturtium ...25, 26 |
| Argemone 8 | Chives50, 62 | Feverfew 24, 71 | Incarvillea 22 | Nemesia 26 |
| Aristolochia 80 | Chorizanthe 14 | Fir 81 | Inula 22 | Nemophila 26 |
| Armeria8, 72 | Christmas Rose .. 73 | Flame Flower..37, 75 | Ipomoea 22 | Nepeta 4, 74 |
| Artemisia 72 | Chrysanthemums
.....1, 14, 71, 73 | Flower Seed Novel-
ties for 1937... 1-4 | Iris 22, 80 | Nicotiana 27, 71 |
| Artichoke 43, 62 | Cineraria 14 | Flowering Crab .. 79 | Ivy 80 | Nierembergia 27 |
| Asclepias8, 72 | Clarkia 14 | Flowering Rasp-
berry 78 | Japanese Quince.. 78 | Nigella 27 |
| Ash 79 | Clematis14, 80 | Foliage Plants .. 71 | Jerusalem Cherry 35 | Nolana 27 |
| Asparagus 8 | Cleome 14 | Forget-me-not 25, 74 | Jetbead 77 | Nycterinia 27 |
| Asparagus (Vege-
table) ..41, 43, 62 | Clianthus 14 | Forsythia 77 | Judas-Tree 79 | Oak 79 |
| Asperula 8 | Climbing Plants.. 80 | Four O'Clock 25 | Juniper 81 | Oat Grass 64 |
| Asphodelus 8 | Clover 65 | Foxglove 17, 73 | Kaffir Corn 66 | Oats 66 |
| Asters..1, 8-10, 71, 72 | Cobaea15, 71 | Francoa 18 | Kale 50 | Oenothera 27, 74 |
| Aubrietia ... 4, 10, 72 | Cockscomb 13 | Freesia 18 | Kalanchoe 22 | Okra 53 |
| Azalea 77 | Collards 50 | Fringe Tree 77 | Kochia 22 | Onions 42, 54 |
| Baby's Breath..20, 73 | Collinsia 15 | Fruit Trees 84 | Kohlrabi 50 | Onion Sets 54 |
| Balloon Vine 10 | Columbine7, 72 | Fruits, Small 85 | Kolkwitzia 77 | Orchard Grass ... 64 |
| Balsam10, 22 | Commelina 15 | Fuchsia 19, 71 | Kudzu Vine 22 | Oxalis 27 |
| Baptisia 10, 72 | Convallaria 67 | Gaillardia 19, 73 | Lantana 22, 71 | Pachysandra 83 |
| Barberry77, 80 | Convolvulus 15 | Garlic 50 | Larkspur 16, 73 | Pansies 2, 27, 28, 38, 71, 75 |
| Barley 66 | Coralberry 77 | Gaura 19 | Lathyrus 22 | Papaver 30, 74 |
| Bartonia 10 | Coreopsis12, 73 | Gazania 19 | Lavandula.. 4, 22, 74 | Parsley 42, 54 |
| Beans ..41, 43, 44, 66 | Corn, Field..... 66 | Genista 19 | Lavatera 22 | Parsnips 56 |
| Beans, Flowering. 10 | Corn, Kaffir..... 66 | Gentiana 19 | Lawn Grass...63, 65 | Passiflora 28 |
| Beautybush 77 | Corn Salad..... 50 | Geranium 19, 71 | Leek 51 | Peaches 84 |
| Bedding Plants... 71 | Cornus77, 79 | Gerardia 19 | Leptosyne 23 | Pears 84 |
| Beech 79 | Cotoneaster 77 | Gerbera 19 | Lettuce ...41, 51, 62 | Peas...22, 42, 55, 56 |
| Beets41, 45, 66 | Crab, Flowering .. 79 | Gesneria 19 | Leucothoe 83 | Peas, Field 66 |
| Begonias
.....1, 10, 11, 70, 71 | Cress 50 | Geum 19, 73 | Liatris 23, 74 | Pea-tree, Siberian 78 |
| Bellflower12, 72 | Cucumber 49 | Gilia 19 | Lilac 78, 80 | Pentstemon .. 28, 74 |
| Bellis 11 | Cuphea 15 | Gilliflower 35 | Lilies.1, 23, 67, 73, 74 | Peonies 74, 75 |
| Berberis 77 | Cyclamen 15 | Gladiolus68, 69 | Lily-of-the-Valley
..... 67, 74 | Pepper56, 62 |
| Bignonia 80 | Cynodossium 15 | Gladium 19 | Linaria1, 23 | Pepperbush 78 |
| Birch 79 | Cyperus 15 | Globe Amaranth.. 19 | Linden 79 | Pepper Grass ... 50 |
| Bird Seeds..... 65 | | | Linum 4, 23, 74 | Perennials 72-75 |
| Blackberries 85 | | | Lobelia ... 23, 71, 74 | Perennial Rye
Grass 64 |
| Blanketflower ..19, 73 | | | Lonicera77, 80 | Perilla 28 |
| Bleeding Heart... 73 | | | Lophospermum ... 23 | Petunias 2, 28, 29, 71 |
| Bocconia11, 72 | | | | Phacelia 29 |
| Boltonia11, 72 | | | | |
| Borecole 50 | | | | |

INDEX—Continued

- Philadelphus 78
 Phlox 29, 71, 75
 Physalis 29
 Physostegia 29, 75
 Pine 82
 Pinks 16, 73
 Platycodon 29, 75
 Plumbago 75
 Plums 84
 Polemonium 30
 Polygonum 80
 Poplar 79
 Poppies 11, 18,
 30, 33, 74
 Portulaca 30
 Potatoes 57
 Potentilla 30
 Primroses
 27, 31, 32, 74, 75
 Primula 3, 31, 32, 75
 Privet 78, 80
 Pumpkin 57
 Pyrethrum 32, 75
 Quince, Japanese 78
 Quinces 84
 Radish 57
 Ranunculus 32
 Rape 65, 66
 Raspberries 85
 Raspberry, Flower-
 ing 78
 Red Top 64
 Reseda 24-25
 Retinospora 82
 Rhodanthe 32
 Rhode Island Bent 65
 Rhododendron 83
 Rhodotypos 77
 Rhubarb 58, 62
 Ricinus 32, 71
 Rock Garden Plants 4
 Romneya 33
 Roots and Plants 62
 Rose of Sharon 77
 Roses 76
 Rudbeckia 33, 75
 Rutabaga 61
 Rye 66
 Rye Grass 64
 Saintpaulia 33
 Salpiglossis 2, 33, 71
 Salsify 58
 Salvia 33, 34, 71
 Sanvitalia 34
 Saponaria 34, 75
 Satin Flower 20
 Saxifraga 4
 Scabiosa 2, 34, 75
 Schizanthus 34
 Sea-lavender 35, 75
 Seaside Bent 65
 Sedum 3, 4, 34, 75
 Seeds for Wild
 Gardens 40
 Sensitiveplant 25
 Shamrock 34
 Shrubs 77, 78
 Shrubs, Ever-
 green 83
 Siberian Pea-tree 78
 Sidalcea 34
 Silene 4, 35
 Silver Lace Vine 80
 Small Fruits 85
 Smilax 35
 Smoke Bush 78
 Snapdragon 71
 Snowberry 78
 Soja Beans 66
 Solanum 35
 Sorghum 66
 Sorrel 58
 Specialties in
 Flower Seed 1-4
 Specialties in Veg-
 etable Seed 41
 Spinach 42, 53, 58
 Spiraea 75, 78, 80
 Spruce 80, 82
 Squash 42, 59
 Statice 35, 75
 Stephanandra 78
 Stevia 35
 Stocks 3, 24, 35, 36
 Stokesia 36, 75
 Strawberries 85
 Streptocarpus 36
 Sudan Grass 66
 Sunflower 20, 66
 Swainsona 36
 Sweet Clover 36
 Sweet Lavender 22
 Sweet Peas 36, 37
 Sweet Potatoes 57
 Sweet Vernal 64
 Sweet William 37, 73
 Symphoricarpos 77, 78
 Syringa 78
 Tarragon Plants 62
 Thalictrum 37
 Thermopsis 37
 Thunbergia 3, 37
 Thymus 75
 Timothy 64
 Tithonia 37
 Tobacco 62
 Tomato 42, 60, 61, 62
 Torenia 37, 71
 Trees, Deciduous 79
 Evergreen 81, 82
 Fruit 84
 Tritoma 37, 75
 Trollius 38, 75
 Tropaeolum 38
 Tuberoses 70
 Tunica 4
 Turnip 61
 Ursinia 38
 Valerian 38
 Vegetable Oyster 58
 Vegetable Roots
 and Plants 62
 Vegetable Seed 43-61
 Specialties 41, 42
 Verbena 38, 71
 Velvet Bent 65
 Venidium 38
 Verbascum 38
 Verbena 38, 71
 Veronica 4, 38, 75
 Vetches 66
 Viburnum 78
 Vinca 38, 71, 75, 83
 Vines 80
 Viola 3, 38, 39, 75
 Virginian Stock 39
 Viscaria 3, 39
 Wallflower 39, 71
 Watermelon 41, 52
 Weigela 78
 Wheat 66
 Wild Garden Flow-
 er Seeds 40
 Willow 79
 Wisteria 80
 Wood Meadow
 Grass 64
 Xeranthemum 39
 Yew 82
 Yucca 39, 83
 Zea 39
 Zinnia 3, 39, 71
- SUNDRIES**
- A. A. Super Phos-
 phate 98
 Agricultural Chem-
 icals and Fertiliz-
 ers 98
 Adco 98
 Adjusto Plant
 Supports 90
 Antipestleck 90
 Ant Trap 97
 Aphine 97
 Arsenate of Lead 97
 Ashes, Hardwood 98
 Asparagus Buncher 86
 Asparagus Knife 86
 Axes 86
 Bamboo Poles 86
 Bands, Rubber 86
 Barrels 90
 Barrows 86
 Barrow Leaf
 Rack 86, 90
 Bars, Crow 86
 Baskets 86
 Bovung 98
 Bill Hooks 86
 Black Leaf 40, 97
 Blood Tankage 98
 Bon Arbor 98
 Bone 98
 Books 101
 Bordeaux Mixture 97
 Bowker's Fertilizer 98
 Boxes, Corrugated 86
 Boxes, Flower 86
 Bulb and Seed
 Pans 87
 Burlap 87
 Burning Brands 87
 Bush Hooks 87
 Bye, Bye, Black-
 bird 97
 Calcium Chloride 98
 Carbola 97
 Carnation Supports 87
 Castor Pomace 98
 Cattle Manure 98
 Celery Wrappers 87
 Charcoal 98
 Clay's Fertilizers 98
 Copper, Ammoniated
 Solution 97
 Corn Planter 96
 Cotton Wadding 87
 Cottonseed Meal 98
 Creosote 97
 Cultivator
 87, 92, 93, 96
 Cyanogas 97
 Dibbles 87
 Dusters 90, 91, 92
 Edging Knives 87
 Electric Tape 87
 Farm and Garden
 Tools and Imple-
 ments 96
 Farm, Garden and
 Lawn Requisites,
 Tools, etc. 86-98
 Fern Roots 98
 Fertilizers 98
 Fertilizer Distrib-
 utor 96
 Floral Tools 87
 Flower Pots, Sauc-
 ers, etc. 87
 Flower Pot Hang-
 ers 87
 Flower Vases 87
 Forks, Miscellan-
 eous 87, 89
 Formacide 97
 Fungicides 97
 Fungtrogen 97
 Garden Books 101
 Garden Grower 93
 Garden Lines 87
 Garden Reels 87
 Garden Requisites 86, 98
 Gardener's Gloves 87
 Glass Cutter 87
 Glaziers' Points 87
 Gloves 87
 Goat Manure 98
 Grafting Knife 87
 Grafting Wax 87
 Grape Dust 97
 Grass Catchers 94
 Grass Hooks 87
 Grey's Plant Food 98
 Grindstones 87
 Ground Bone 98
 Hammers 87
 Hand Cart, Box,
 etc. 90
 Hand Garden
 Tools 92, 93
 Handles 87
 Harrows 96
 Hatchets 87
 Hay Forks 87
 Hedge Shears 89
 Herbicide 97
 Hoes 87, 88, 92, 96
 Hose, Rubber 88
 Hose Clamps 88
 Hose Connections 88
 Hose Couplings 88
 Hose Menders 88
 Hose Nozzles 88
 Hose Reducers 88
 Hose Reels 88
 Hose Washers 88
 Hotbed Mats 88
 Hotbed Sash 89
 Humus 98
 Insecticides and
 Fungicides 90, 97
 Knives, Budding 88
 Labels 88
 Lawn Mowers,
 Power 93
 Lawn Mowers,
 Hand 94
 Lawn Mower Serv-
 ice Department 94
 Lawn Rollers 95
 Lawn Sand 98
 Leaf Mold 98
 Leaf Rack 90
 Lemon Oil 97
 Lime 97, 98
 Lime-Sulphur Solu-
 tion 97
 Manure 98
 Manure Forks 87
 Mats, Hotbed 88
 Mattocks 88
 Melon Nets 88
 Mole Traps 88
 Moss 98
 Mowrah Meal 98
 Muriate of Potash 98
 Naptoside 98
 Nico-Fume
 Products 97
 Nitrate of Soda 98
 Oilers 88
 Oil 88
 Orchid Peat 98
 Pails 88
 Pans, Bulb and
 Seed 87
 Paper 88
 Peat 98
 Pencils 88
 Picks 88
 Plant Food 98
 Plant Sprinklers 89
 Plant Tubs 88, 89
 Plant Food Tablets 98
 Plows 92, 93, 96
 Poles 89
 Pomo-Green with
 Nicotine 97
 Post Hole Digger 89
 Potato Hoe 96
 Poultry Manure 98
 Pruners 89
 Pulverized Manure 98
 Pumps 89, 91
 Putty Bulb 89
 Putty 89
 Pyrethrum-Rote-
 none Cartridge 90
 Pyrox 97
 Raffia 89
 Rakes 88, 89
 Red Arrow Insect
 Spray 97
 Richard's X L All
 Rollers 96
 Rope 89
 Rotenone Dust 97
 Salt 98
 Sand, Silver 98
 Sash, Hotbed 89
 Saws 89
 Scalecide 97
 Scissors 89
 Scoops 89
 Scrapers 96
 Scythes 89
 Scythe Stones 89
 Seed Drill 92
 Seed Pans 87
 Seed Sower 89
 Seeders 92
 Semesan 97
 Shears 89
 Sheep Manure 98
 Shelton's Baskets 86
 Shovels 89
 Sickles 87
 Silkline 89
 Silver Sand 98
 Slug Shot 97
 Snarol 97
 Soap Spray 97
 Soap, Fish Oil 97
 Sod Lifter 89
 Soot 98
 Spades 89
 Spading Forks 87
 Sprayers and
 Dusters 90, 91, 92
 Sprinklers 95
 Stake Fasteners 89
 Stakes, Garden 89, 90
 Sticks, Match 90
 Stockbridge
 Manure 98
 Stone Boats 96
 Styptic 90
 Sulphate of Am-
 monia 98
 Sulphur Cartridge 90
 Sulphur Flour 97
 Superphosphate
 A. A. 98
 Tamper 90
 Thermometers 90
 Thrip Juice 97
 Tinfoil 90
 Tobacco Dust 97
 Tobacco Stems 97
 Tree Scrapers 90
 Trellises 90
 Tri-O-Gen 98
 Trowels 90
 Truck 90
 Trunnions 90
 Tubs, Plant 88, 89
 Twine 90
 Vermine 97
 Volck 97
 Watering Pots 90
 Wayward Vine
 Guide and
 Support 87
 Wedges 90
 Weeders 90, 96
 Weed Exterminator
 97
 Weed Puller 90
 Wheelbarrows 86
 Wheel Hoe 92
 Wilson's O. K.
 Plant Spray 97
 Wire 90
 Wrenches 90

Practical Books for the Home Gardener



GARDEN MAINTENANCE. By H. Stuart Ortloff and Henry B. Raymore. Illustrated with photographs and drawings. Frontispiece in color. \$2.50.

THE BOOK OF BULBS. By F. F. Rockwell. 187 illustrations, 264 pages. \$2.00.

THE GARDENER. By L. H. Bailey. 116 illustrations, 260 pages. \$2.00.

THE CULTIVATED CONIFERS. By Dr. L. H. Bailey, 404 pages, 162 illustrations. \$7.50.

FERTILIZERS. By E. B. Voorhees. Revised by S. B. Haskell. 29 illustrations, 310 pages. \$2.50.

INFORMAL GARDENS. By H. Stuart Ortloff. 104 pages, 17 illustrations. \$1.60.

THE HOME GARDEN HANDBOOKS. By F. F. Rockwell. \$1.25 per volume. The titles now published are: Rock Gardens; Irises; Dahlias; Gladiolus; Roses; Peonies; Evergreens; Shrubs; Lawns.

AROUND THE YEAR IN THE GARDEN. By F. F. Rockwell. 88 illustrations, 350 pages. \$2.50.

ANNUALS IN THE GARDEN. By H. Stuart Ortloff, L. A. Cloth 12 mo. \$1.25.

PERENNIAL GARDENS. By H. Stuart Ortloff. 92 pages. 18 illustrations. \$1.25.

GARDEN POOLS—LARGE AND SMALL. By Ransley and Lawrence. 41 illustrations, 122 pages. \$2.50.

THE GARDEN CLUB MANUAL. By Edith R. Fisher. \$2.00.

THE HOME VEGETABLE GARDEN. By E. M. Freeman. 8 illustrations, 214 pages. \$1.75.

GARDEN FLOWERS IN COLOR. A cyclopedia of flower pictures. 320 pages, 400 photographs in color. \$3.75.



Important to Customers

ORDER EARLY.—We would suggest that customers send us their orders as soon as possible after receiving this catalog, and thus avoid the rush of the planting season. It frequently happens that some articles are not in stock when orders are received. In such cases we forward such as are ready, and the balance as soon as possible.

STOCK SEED.—A large part of our seeds are grown for us on contract by special growers, from our own stock, and in locations best suited for their development. Others are secured from strictly reliable sources, and constant effort is made to secure only the best.

ADDRESS, ETC.—Give name of your **Post Office, County and State**, sign your name plainly; also specify means of conveyance preferred—whether by parcel post, express or freight.

SHIPPING.—We deliver free to Express, Railroad or Boat. All goods travel at the buyer's risk, our responsibility ceases when we take the carrier's receipt. If goods are damaged so sign for them and enter claim with the carrier at once. Free delivery, see page 62.

BAGS AND PACKING.—No charge is made for boxes or packing on anything, except **Flower Pots, Nursery Stock and Hotbed Sash**, and this at cost only. **Cloth Bags** are charged for at cost and if returned in good condition, charges prepaid, will be credited at price charged.

REMITTANCES.—May be made by **Express Money Order, P. O. Money Order or Bank Draft**; if stamps or cash, send in a **Registered Letter**. Parties having no account with us, who order goods without remittance, must furnish satisfactory references. Boston preferred.

Due to the unsettled market conditions, we cannot guarantee the prices published in this catalog. Each sale will be subject to current prices and also to any Federal or State Sales Tax in effect. Advances will not be made until necessary.

TERMS ARE NET CASH.—All bills on which short credits are allowed are due on the first of the month succeeding the date of the purchase.

WARRANTY.—We give no warranty, expressed or implied, as to quality, description, productiveness, or any other matter of any Seeds, Bulbs or Plants we send out, and will not be in any way responsible for the crop. If the purchaser does not accept the goods on these terms, they must at once be returned.

PARCEL POST RATES

Packages must not exceed 100 inches in length and girth combined. Seventy pounds is the limit of weight.

Wght. in Lbs.	ZONES							
	Local	1st	3rd	4th	5th	6th	7th	8th
		2nd	150 to 300 miles	300 to 600 miles	600 to 1000 miles	1000 to 1400 miles	1400 to 1800 miles	Over 1800 miles
1....	\$0.07	\$0.08	\$0.09	\$0.10	\$0.11	\$0.12	\$0.14	\$0.15
2....	.08	.10	.11	.14	.17	.19	.23	.26
3....	.08	.11	.13	.17	.22	.26	.32	.37
4....	.09	.12	.15	.21	.27	.33	.41	.48
5....	.09	.13	.17	.24	.33	.40	.50	.59
6....	.10	.14	.19	.28	.38	.47	.59	.70
7....	.10	.15	.21	.31	.43	.54	.68	.81
8....	.11	.16	.23	.35	.49	.61	.77	.92
9....	.11	.17	.25	.38	.54	.68	.86	1.03
10....	.12	.18	.27	.42	.59	.75	.95	1.14
11....	.12	.19	.29	.45	.64	.82	1.04	1.25
12....	.13	.21	.31	.49	.70	.89	1.13	1.36

Postage on seeds, bulbs, plants and roots of 8 ounces or less to all zones, is 1c for each 2 ounces.

Postage on general merchandise of 8 ounces or less, to all zones, is 1½c for each 2 ounces.

GARDENERS' AND SUPERINTENDENTS' SITUATIONS. We have at all times the names of practical gardeners and superintendents in want of situations on our books. If parties desiring such will write us, we shall be glad to put them in communication with men whom we deem suitable. To aid us in making a selection we ask full particulars. We make no charge for this service.

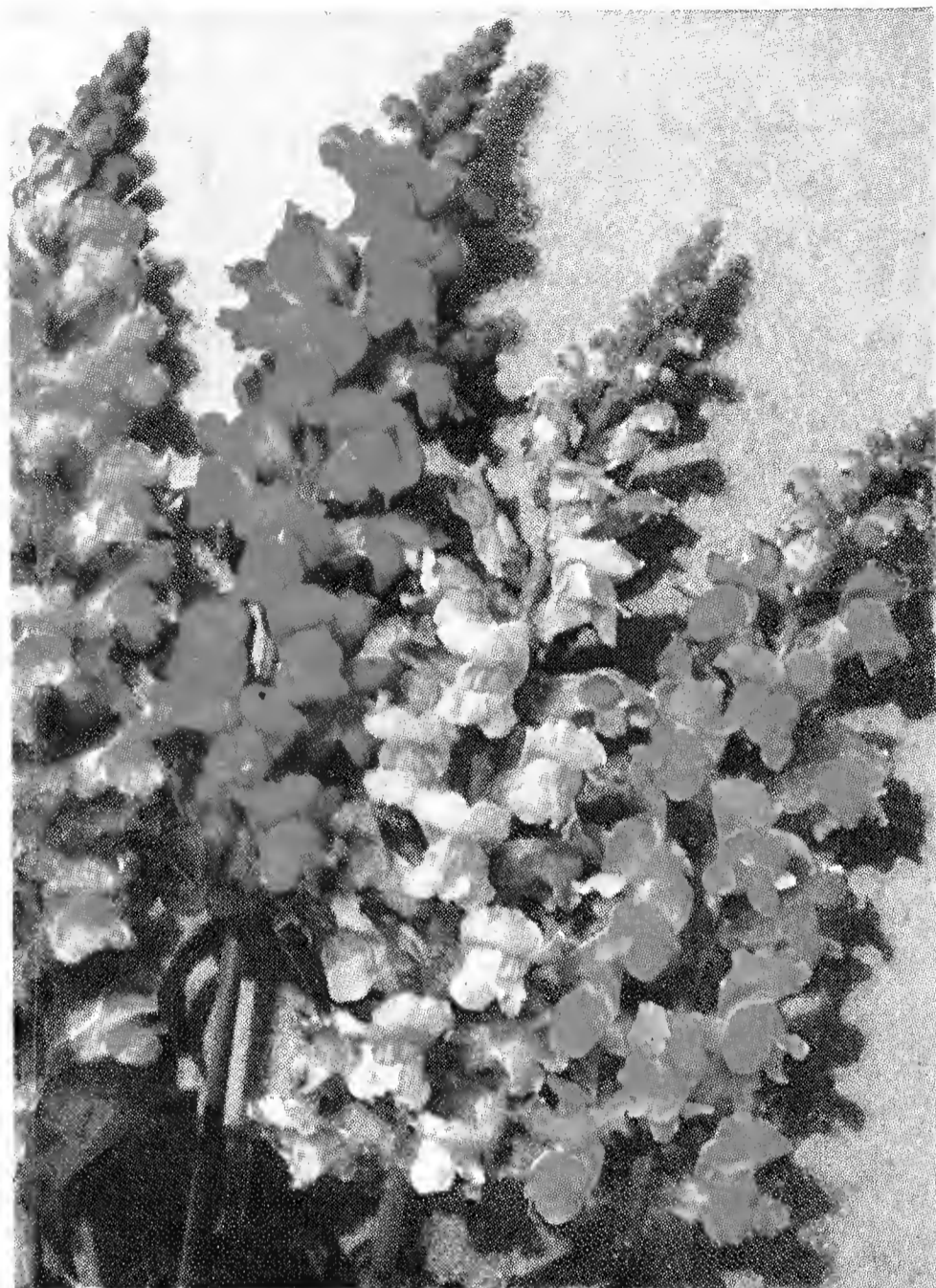

NEW ANTIRRHINUM
Rust Proof Super Majestic
(See Page 1)

SEEDS BULBS *and* PLANTS

AGRICULTURAL
IMPLEMENTS

for
1937

THOMAS J. GREY COMPANY
The Seedsmen

16 South Market St., BOSTON, MASSACHUSETTS
